

Data sheet | Item number: 756-1504/060-050

System bus cable for drag chain; 5-pole; Length: 5 m

[www.wago.com/756-1504/060-050](http://www.wago.com/756-1504/060-050)

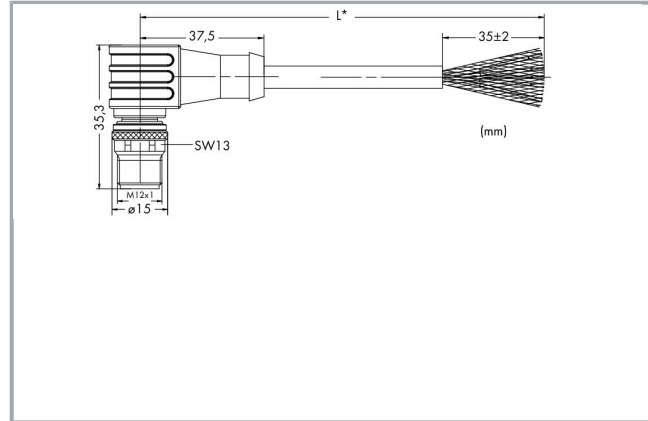

Subject to changes. Please also observe the further product documentation!

WAGO Kontakttechnik GmbH & Co. KG  
Hansastr. 27  
32423 Minden  
Phone: +49571 887-0 | Fax: +49571 887-169  
Email: [info.de@wago.com](mailto:info.de@wago.com) | Web: [www.wago.com](http://www.wago.com)

Do you have any questions about our products?  
We are always happy to take your call at +49 (571) 887-44222.

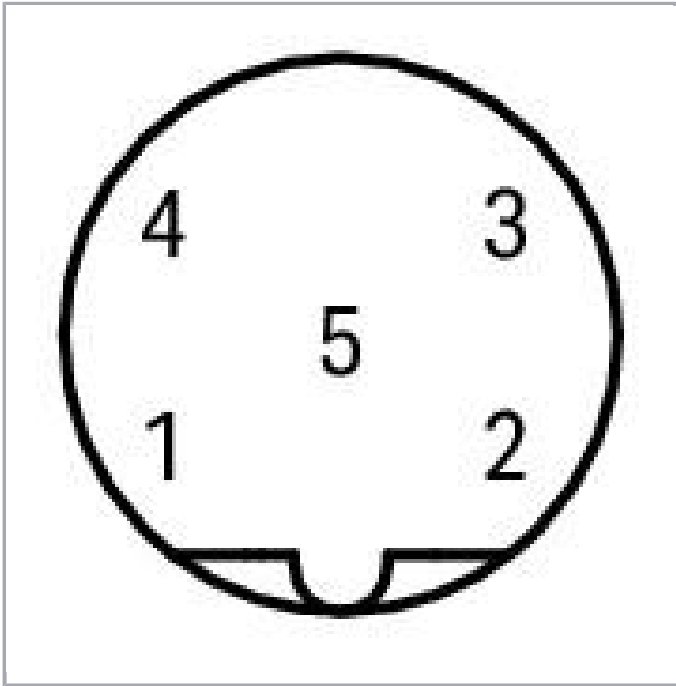

Pin 1 ... 5: 0,14 mm<sup>2</sup>

1	rot	■ 1
2	schwarz	■ 2
3	blau	■ 3
4	braun	■ 4
5	gelb, grün, orange, grau	■ 5

Schirm

## Item description

### Short description:

- PUR, halogen-free
- Suitable for drag chains
- Silicon- and CFC-free
- High resistance to microbes, hydrolysis, oil, chemicals and UV radiation High chemical resistance

## Data

### Technical Data

Connection type	M12 plug - free end
No. of poles	5
Leitungsanschlussrichtung zur Steckrichtung	90°
Steckgesichtskodierung Leitung/Adapter 1 1	B-coded
Cable length	5 m
Operating voltage	60 V
Operating current	4 A
Rated surge voltage	1.5 kV per IEC 61076-2-101
Contact resistance	10 MΩ
Insulation resistance	5000 MΩ

Subject to changes. Please also observe the further product documentation!

WAGO Kontakttechnik GmbH & Co. KG  
 Hansastr. 27  
 32423 Minden  
 Phone: +49571 887-0 | Fax: +49571 887-169  
 Email: [info.de@wago.com](mailto:info.de@wago.com) | Web: [www.wago.com](http://www.wago.com)

Do you have any questions about our products?  
 We are always happy to take your call at +49 (571) 887-44222.



Resistance of conductor	≤ 130 Ω/km
-------------------------	------------

## Mechanical data

bending radius	5 x cable diameter (min.)
Bending cycles	5 Mio.
Schleppkettentauglichkeit	yes
Cable diameter	6,8 mm
Bauartkurzzeichen	KS-6Y3GC11Y 4x2xAWG26/19 shielded
Screening	Tinned copper braid, optical coverage approx. 90 %
Conductor design	Bare copper wire (AWG 26/19)
Leiterisolierung	FEP; Core Ø: 1.0 mm (max.)
Housing material	TPU/TPU, black (~ RAL 9005)
Contact material	CuZn
Contact plating	CuNi/Au
Materialeigenschaften der Anschlüsse	Hexagon knurled nut: CuZn; Knurled nut surface: nickel-plated; Sealing ring: FPM (Viton)
Mating cycles	100
Tightening torque	1 Nm
Weight	10 g
Color	yellow

## Environmental Requirements

Umgebungstemperatur (Betrieb) bewegt	0 ... +50 °C
Umgebungstemperatur (Betrieb) ruhend	-30 ... +50 °C
Protection class	IP67
Degree of pollution (5)	3/2 per IEC 60664-1

## Commercial data

Packaging type	BOX
Country of origin	DE
GTIN	4050821130987
Customs Tariff No.	85444290900

## Counterpart

Subject to changes. Please also observe the further product documentation!

WAGO Kontakttechnik GmbH & Co. KG  
 Hansastr. 27  
 32423 Minden  
 Phone: +49571 887-0 | Fax: +49571 887-169  
 Email: [info.de@wago.com](mailto:info.de@wago.com) | Web: [www.wago.com](http://www.wago.com)

Do you have any questions about our products?  
 We are always happy to take your call at +49 (571) 887-44222.



## Downloads

### Documentation

#### System Description

I/O-SYSTEM – SPEEDWAY, General Product Information

pdf  
1.1 MB

[Download](#)

---

### CAD/CAE-Data

#### CAE data

WSCAD Universe 756-1504/060-050

URL

[Download](#)

---

## Installation Notes

Subject to changes. Please also observe the further product documentation!

---

WAGO Kontakttechnik GmbH & Co. KG

Hansastr. 27

32423 Minden

Phone: +49571 887-0 | Fax: +49571 887-169

Email: [info.de@wago.com](mailto:info.de@wago.com) | Web: [www.wago.com](http://www.wago.com)

Do you have any questions about our products?

We are always happy to take your call at +49 (571) 887-44222.