

Data sheet | Item number: 750-979/000-022

Connector ETHERNET; RJ-45; Cat. 6A; angled; Code T568B; AWG 24; Strain relief



www.wago.com/750-979/000-022



RoHS Compliant

[BOMcheck.net](https://www.bomcheck.net)

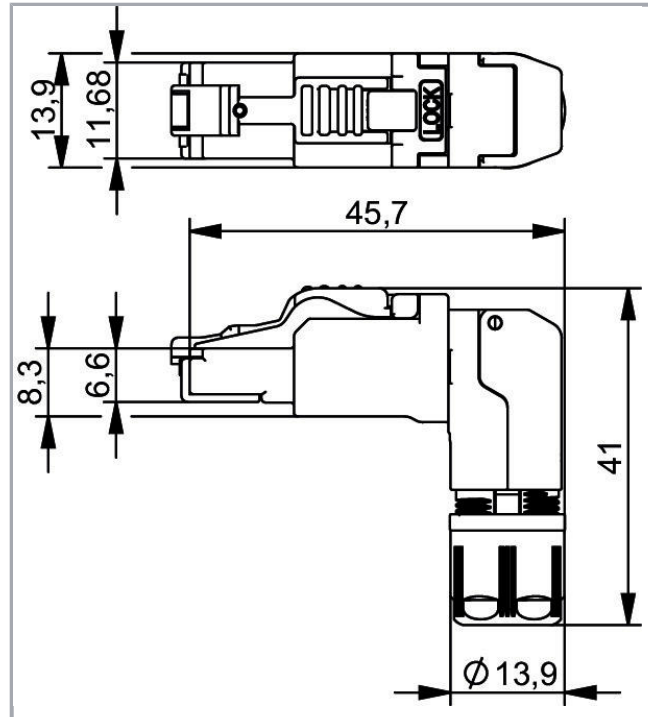

Pin assignment TIA-568B

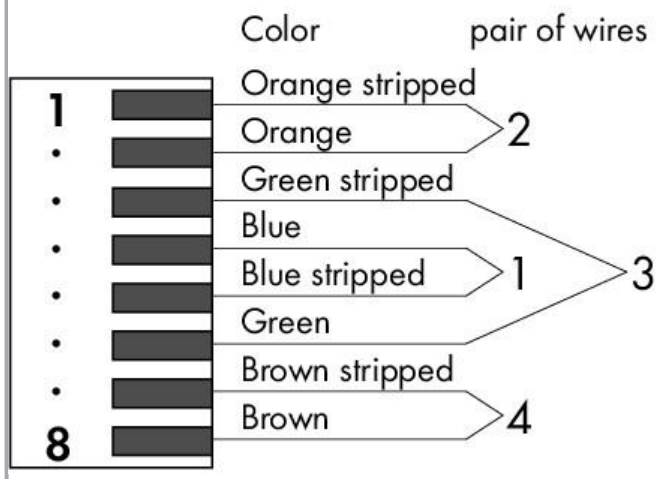

Subject to changes. Please also observe the further product documentation!

WAGO Kontakttechnik GmbH & Co. KG
Hansastr. 27
32423 Minden
Phone: +49571 887-0 | Fax: +49571 887-169
Email: info.de@wago.com | Web: www.wago.com

Do you have any questions about our products?
We are always happy to take your call at +49 (571) 887-44222.

Data

Technical Data

Connection type	RJ-45 plug
No. of poles	8
Leitungsanschlussrichtung zur Steckrichtung	90°
Leitungsanschlussrichtung Hinweis	selectable position
Communication/Fieldbus	Ethernet
Code	TIA-568B
Baud rate	-

Connection data

Connection type (1)	IDC contact
Solid conductor	0,13 ... 0,21 mm ² / 26/1 ... 24/1 AWG
Stranded conductor (2)	0,11 ... 0,23 mm ² / 27/7 ... 24/7 AWG

Geometrical Data

Width	13,9 mm
Height	41 mm
Depth	45,7 mm

Mechanical data

Connection requirement (permissible cable type)	Cat. 6 A
Connectable sheathed cable diameter	5,5 ... 10 mm
Housing material	Zinc die casting
Weight	26 g

Environmental Requirements

Surrounding air (operating) temperature	-40 ... 85 °C
Surrounding air (storage) temperature	-40 ... 85 °C
Protection class	IP20
Relative air humidity (no condensation)	95 %
Standards/specifications	IEC60603-7-51, ISO/IEC 11801, IEEE 802.3an; EIA/TIA 568-C.2; DIN EN 50173-1; UL 1863; UL 2043

Commercial data

Packaging type	bag
----------------	-----

Subject to changes. Please also observe the further product documentation!



Country of origin	TW
GTIN	4055143586320
Customs Tariff No.	85366990990

Approvals / Certificates

UL-Approvals

Logo	Approval	Additional Approval Text	Certificate name
	UL Underwriters Laboratories Inc.	UL 1977	E345416

Counterpart

Downloads

Documentation

Additional Information

Disposal; Electrical and electronic equipment, Packaging	V 1.0.0	pdf 265.8 kB	Download
--	---------	-----------------	----------

Installation Notes

Subject to changes. Please also observe the further product documentation!

WAGO Kontakttechnik GmbH & Co. KG
Hansastr. 27
32423 Minden
Phone: +49571 887-0 | Fax: +49571 887-169
Email: info.de@wago.com | Web: www.wago.com

Do you have any questions about our products?
We are always happy to take your call at +49 (571) 887-44222.