

# Data sheet | Item number: 750-880/040-000

Controller ETHERNET; 3rd Generation; SD Card Slot; Extreme; dark gray

[www.wago.com/750-880/040-000](http://www.wago.com/750-880/040-000)



RoHS Compliant

[BOMcheck.net](http://BOMcheck.net)

Color:

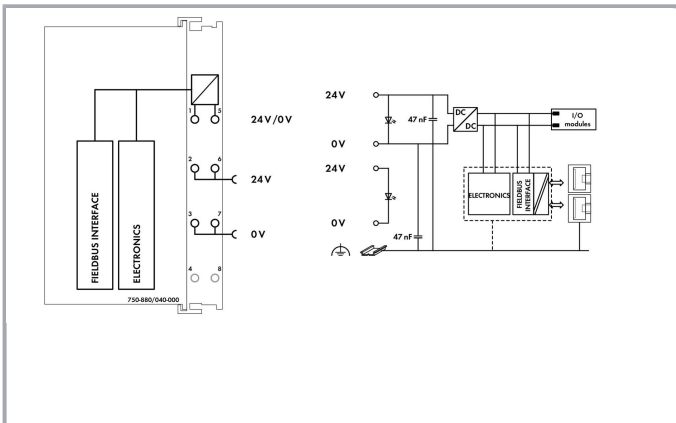
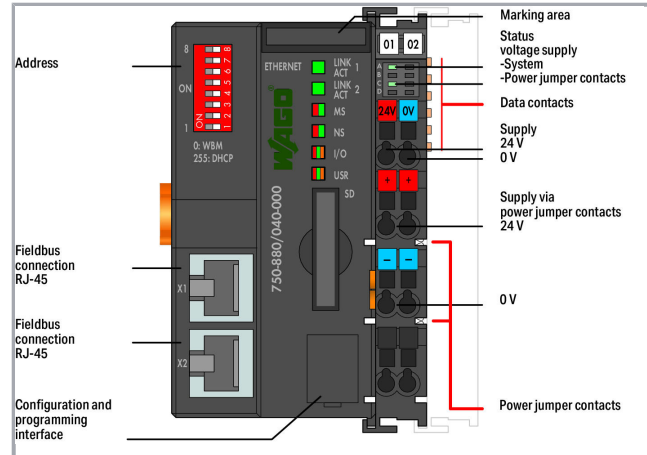

Subject to changes. Please also observe the further product documentation!

WAGO Kontakttechnik GmbH & Co. KG  
Hansastr. 27  
32423 Minden  
Phone: +49571 887-0 | Fax: +49571 887-169  
Email: [info.de@wago.com](mailto:info.de@wago.com) | Web: [www.wago.com](http://www.wago.com)

Do you have any questions about our products?  
We are always happy to take your call at +49 (571) 887-44222.

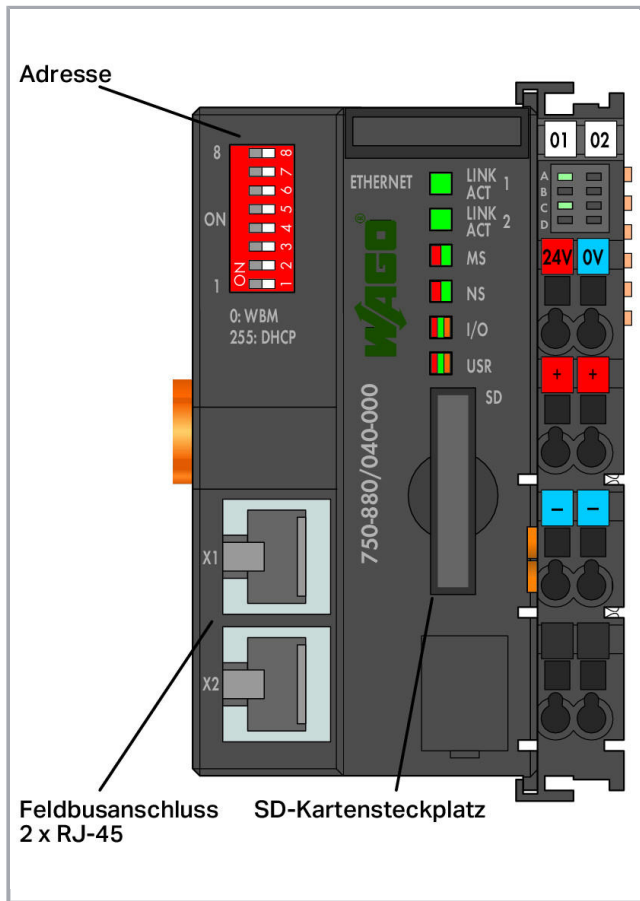

## Item description

The ETHERNET Controller can be used as a programmable controller within ETHERNET networks in conjunction with the WAGO I/O System.

The controller supports all digital, analog and specialty modules found within the 750/753 Series, and is suitable for data rates of 10/100 Mbit/s.

Two ETHERNET interfaces and an integrated switch allow the fieldbus to be wired in a line topology, eliminating the need for additional network devices, such as switches or hubs. Both interfaces support autonegotiation and Auto-MDI(X).

The DIP switch configures the last byte of the IP address and may be used for IP address assignment.

The controller supports both MODBUS/TCP and EtherNet/IP for use in industrial environments. It also supports a wide variety of standard ETHERNET protocols for easy integration into IT environments (e.g., HTTP, BootP, DHCP, DNS, SNMP, FTP).

For telecontrol applications, the 750-880/040-001 Controller supports the IEC 60870-5-101/-103-104, IEC 61850-7 and IEC 61400-25 communication protocols.

An integrated Webserver provides user configuration options, while displaying the controller's status information.

The IEC 61131-3 programmable controller is multitasking-capable and features a capacitor-backed RTC.

A data memory of 1 MB is available.

Subject to changes. Please also observe the further product documentation!



The 750-880 Controller is equipped with a removable memory card slot. A memory card can be used to transfer device parameters or files (e.g., boot files) from one controller to another. The memory card can be accessed via FTP and be used as an additional drive.

The device is ideal for operation in extreme environments thanks to:

- Extended temperature range
- Greater immunity to impulse voltages and electromagnetic interference
- Higher vibration and shock resistance

## Data

### Technical Data

Communication	EtherNet/IP Modbus (TCP, UDP) Ethernet
Ethernet protocol	HTTP BootP DHCP DNS SNTP FTP SNMP
Visualization	Web Visu
CPU	32 bits
Programming languages per IEC 61131-3	Instruction List (IL) Ladder Diagram (LD) Function Block Diagram (FBD), Continuous Function Chart (CFC) Structured Text (ST) Sequential Function Chart (SFC)
Programming environment	WAGO-I/O-PRO V2.3 (based on CODESYS V2.3)
Configuration options	WAGO-I/O-CHECK Web-based management
Baud rate (communication/fieldbus 1)	10/100 Mbit/s
Baud rate	10/100 Mbit/s
Transmission medium (communication/fieldbus)	Twisted Pair S-UTP; 100 Ω; Cat. 5; 100 m maximum cable length
Transmission performance	Class D per EN 50173
Program memory	1024 kByte
Data memory	1024 kByte
Software non-volatile memory	32 Kbytes
Type of memory card	SD and SDHC up to 32 GB (all guaranteed properties only valid with WAGO 758-879/000-001 Memory Card)
Memory card slot	Push-push mechanism; Cover lid (sealable)
Number of modules per node max.	64

Subject to changes. Please also observe the further product documentation!



Input and output process image (Fieldbus) max.	1020 Worte/1020 Worte
Indicators	LED (LINK/ACT) green: Network connection via ports 1 ... 2; LED (MS, NS) red/green: Status of node, network; LED (I/O, USR) red /green/orange: Local data bus status, status programmable by user; LED (A, B) green: System power supply status, field supply
Derating	Total current for system supply: 1700 mA (surrounding air (operating) temperature < 60 °C; 1500 mA (surrounding air (operating) temperature: 60 ... 70 °C)
System supply voltage	DC 24 V(-25 ... +30 %); via pluggable connector (CAGE CLAMP® connection) Specified values for surrounding air temperatures: +15 ... +35 °C for -40 ... +55 °C; 24 V (-25 ... +20 %) for +55 ... +70 °C; 24 V (-25 ... +10 %) Lower limit in all temperature ranges: -27.5 % (including 15 % residual ripple)
Input current typ. at rated load (24 V)	500 mA
Efficiency of the power supply (typ.) at nominal load (24 V)	90 %
Current consumption, system supply (5 V)	450 mA
Total current for system supply	1,700 mA
Field supply voltage	DC 24 V; via power jumper contacts
Current carrying capacity of the power jumper contacts	10 A
Number of outgoing power jumper contacts	2
Ratings per	IEC/EN 60664-1
Rated surge voltage	1 kV

## Connection data

Connection technology: communication/fieldbus	EtherNet/IP: 2 x RJ-45; Modbus TCP/UDP: 2 x RJ-45
Connection technology: system supply	2 x CAGE CLAMP®
Connection technology: field supply	4 x CAGE CLAMP®
Connection type (1)	System/field supply
Solid conductor	0,25 ... 2,5 mm <sup>2</sup> / 24 ... 14 AWG
Fine-stranded conductor	0,25 ... 2,5 mm <sup>2</sup> / 24 ... 14 AWG
Strip length	8 ... 9 mm / 0.31 ... 0.35 inch
Connection technology: Device configuration	1 x Male connector; 4-pole

## Geometrical Data

Width	61,5 mm / 2.421 inch
Height	71,9 mm / 2.831 inch
Height from upper-edge of DIN-35 rail	64,7 mm / 2.547 inch
Depth	100 mm / 3.937 inch

Subject to changes. Please also observe the further product documentation!

WAGO Kontakttechnik GmbH & Co. KG  
Hansastr. 27  
32423 Minden  
Phone: +49571 887-0 | Fax: +49571 887-169  
Email: [info.de@wago.com](mailto:info.de@wago.com) | Web: [www.wago.com](http://www.wago.com)

Do you have any questions about our products?  
We are always happy to take your call at +49 (571) 887-44222.



## Mechanical data

Weight	167 g
Color	dark gray
Housing material	Polycarbonate, polyamide 6.6
Conformity marking	CE

## Environmental Requirements

Surrounding air (operating) temperature	-40 ... 70 °C
Surrounding air (storage) temperature	-40 ... 85 °C
Protection class	IP20
Degree of pollution (5)	2 per IEC 61131-2
Operating altitude	without temperature derating: 0 ... 2000 m; with temperature derating: 2000 ... 5000 m (0.5 K/100 m); 5000 m (max.)
Relative air humidity (no condensation)	95 %
Relative humidity	Short-term condensation per Class 3K7/IEC EN 60721-3-3 and E-DIN 40046-721-3 (except for wind-driven precipitation, water and ice formation)
Mounting position	horizontal (standing/lying); vertical
Type of mounting	DIN-35 rail
Vibration resistance	per IEC 60068-2-6 (acceleration: 5g), EN 60870-2-2, IEC 60721-3-1, -3, EN 50155; EN 61373
Shock resistance	per IEC 60068-2-27 (15g/11 ms/half-sine/1,000 shocks; 25g/6 ms/1,000 shocks), EN 50155, EN 61373
EMC immunity to interference	per EN 61000-6-1, -2; EN 61131-2; marine applications; EN 50121-3-2; EN 50121-4, -5; EN 60255-26; EN 60870-2-1; EN 61850-3; IEC 61000-6-5; IEEE 1613; VDEW: 1994
EMC emission of interference	per EN 61000-6-3, -4, EN 61131-2, EN 60255-26, marine applications, EN 60870-2-1, EN 61850-3, EN 50121-3-2, EN 50121-4, -5
Exposure to pollutants	Per IEC 60068-2-42 and IEC 60068-2-43
Permissible H <sub>2</sub> S contaminant concentration at a relative humidity 75 %	10 ppm
Permissible SO <sub>2</sub> contaminant concentration at a relative humidity 75 %	25 ppm

## Commercial data

Product Group	15 (Remote I/O)
Packaging type	BOX

Subject to changes. Please also observe the further product documentation!



WAGO Kontakttechnik GmbH & Co. KG  
 Hansastr. 27  
 32423 Minden  
 Phone: +49571 887-0 | Fax: +49571 887-169  
 Email: [info.de@wago.com](mailto:info.de@wago.com) | Web: [www.wago.com](http://www.wago.com)

Do you have any questions about our products?  
 We are always happy to take your call at +49 (571) 887-44222.

Country of origin	DE
GTIN	4050821460121
Customs Tariff No.	85371091990

## Approvals / Certificates

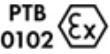

### Ex-Approvals

Logo	Approval	Additional Approval Text	Certificate name
	<b>ATEX</b> TUEV Nord Cert GmbH	EN 60079-0	TUEV 17 ATEX 193969X
	<b>IECEX</b> TUEV Nord Cert GmbH	IEC 60079-0	IECEX TUN 16.0046X
	<b>UL</b> Underwriters Laboratories Inc. (HAZARDOUS LOCATIONS)	UL 121201	E198726 Sec.1

### Country specific Approvals

Logo	Approval	Additional Approval Text	Certificate name
	<b>KC</b> National Radio Research Agency	Article 58-2, Clause 3	MSIP- REM-W43- PFC750

### Ship Approvals

Logo	Approval	Additional Approval Text	Certificate name
	<b>ABS</b> American Bureau of Shipping	-	18- HG1778162- PDA
	<b>DNV GL</b> Det Norske Veritas, Germanischer Lloyd	-	TAA00000Y7
	<b>LR</b> Lloyds Register	-	17/20073 LR

Subject to changes. Please also observe the further product documentation!



PRS

Polski Rejestr Statków

TE/2215

/880590/18





## UL-Approvals

Logo	Approval	Additional Approval Text	Certificate name
	UL UL International Netherlands B.V. (ORDINARY LOCATIONS)	UL 508	E175199 Sec.1

## Counterpart

## Compatible products

### wiring and connectors

	<b>Item no.: 750-975</b> ETHERNET RJ-45 connector, IP20; ETHERNET 10/100 Mbit/s; for field assembly; light gray	<a href="http://www.wago.com/750-975">www.wago.com/750-975</a>
	<b>Item no.: 750-977/000-011</b> Connector ETHERNET; RJ-45; Cat. 6A; straight; Code T568A; AWG 22	<a href="http://www.wago.com/750-977/000-011">www.wago.com/750-977/000-011</a>
	<b>Item no.: 750-977/000-012</b> Connector ETHERNET; RJ-45; Cat. 6A; straight; Code T568B; AWG 22	<a href="http://www.wago.com/750-977/000-012">www.wago.com/750-977/000-012</a>
	<b>Item no.: 750-977/000-021</b> Connector ETHERNET; RJ-45; Cat. 6A; straight; Code T568A; AWG 24	<a href="http://www.wago.com/750-977/000-021">www.wago.com/750-977/000-021</a>

Subject to changes. Please also observe the further product documentation!

WAGO Kontakttechnik GmbH & Co. KG  
Hansastr. 27  
32423 Minden  
Phone: +49571 887-0 | Fax: +49571 887-169  
Email: [info.de@wago.com](mailto:info.de@wago.com) | Web: [www.wago.com](http://www.wago.com)

Do you have any questions about our products?  
We are always happy to take your call at +49 (571) 887-44222.



**Item no.: 750-977/000-022**  
Connector ETHERNET; RJ-45; Cat. 6A; straight; Code T568B; AWG 24

[www.wago.com/750-977/000-022](http://www.wago.com/750-977/000-022)



**Item no.: 750-978/000-011**  
Connector ETHERNET; RJ-45; Cat. 6A; straight; Code T568A; AWG 22; Strain relief

[www.wago.com/750-978/000-011](http://www.wago.com/750-978/000-011)



**Item no.: 750-978/000-012**  
Connector ETHERNET; RJ-45; Cat. 6A; straight; Code T568B; AWG 22; Strain relief

[www.wago.com/750-978/000-012](http://www.wago.com/750-978/000-012)



**Item no.: 750-978/000-021**  
Connector ETHERNET; RJ-45; Cat. 6A; straight; Code T568A; AWG 24; Strain relief

[www.wago.com/750-978/000-021](http://www.wago.com/750-978/000-021)



**Item no.: 750-978/000-022**  
Connector ETHERNET; RJ-45; Cat. 6A; straight; Code T568B; AWG 24; Strain relief

[www.wago.com/750-978/000-022](http://www.wago.com/750-978/000-022)



**Item no.: 750-979/000-011**  
Connector ETHERNET; RJ-45; Cat. 6A; angled; Code T568A; AWG 22; Strain relief

[www.wago.com/750-979/000-011](http://www.wago.com/750-979/000-011)



**Item no.: 750-979/000-012**  
Connector ETHERNET; RJ-45; Cat. 6A; angled; Code T568B; AWG 22; Strain relief

[www.wago.com/750-979/000-012](http://www.wago.com/750-979/000-012)



**Item no.: 750-979/000-021**  
Connector ETHERNET; RJ-45; Cat. 6A; angled; Code T568A; AWG 24; Strain relief

[www.wago.com/750-979/000-021](http://www.wago.com/750-979/000-021)



**Item no.: 750-979/000-022**  
Connector ETHERNET; RJ-45; Cat. 6A; angled; Code T568B; AWG 24; Strain relief

[www.wago.com/750-979/000-022](http://www.wago.com/750-979/000-022)

#### software



**Item no.: 759-333**  
WAGO-I/O-PRO

[www.wago.com/759-333](http://www.wago.com/759-333)



**Item no.: 759-333/000-923**  
WAGO-I/O-PRO; USB-Set

[www.wago.com/759-333/000-923](http://www.wago.com/759-333/000-923)



**Item no.: 759-911**  
WAGO-I/O-PRO; CD

[www.wago.com/759-911](http://www.wago.com/759-911)

#### memory card



**Item no.: 758-879/000-001**  
Memory Card SD; SLC-NAND; 2 GByte; Temperature from -40 to 90 °C

[www.wago.com/758-879/000-001](http://www.wago.com/758-879/000-001)

Subject to changes. Please also observe the further product documentation!



Item no.: 758-879/000-2108

Memory Card SD; pSLC-NAND; 8 GB; Temperature range: -40 to 90°C

[www.wago.com/758-879/000-2108](http://www.wago.com/758-879/000-2108)

---

**Carrier rail**

---

**Item no.: 210-112**

Steel carrier rail; 35 x 7.5 mm; 1 mm thick; 2 m long; slotted; according to EN 60715; "Hole width 25 mm

[www.wago.com/210-112](http://www.wago.com/210-112)**Item no.: 210-113**

Steel carrier rail; 35 x 7.5 mm; 1 mm thick; 2 m long; unslotted; according to EN 60715

[www.wago.com/210-113](http://www.wago.com/210-113)**Item no.: 210-114**

Steel carrier rail; 35 x 15 mm; 1.5 mm thick; 2 m long; unslotted; similar to EN 60715

[www.wago.com/210-114](http://www.wago.com/210-114)**Item no.: 210-115**

Steel carrier rail; 35 x 7.5 mm; 1 mm thick; 2 m long; slotted; according to EN 60715; "Hole width 18 mm

[www.wago.com/210-115](http://www.wago.com/210-115)**Item no.: 210-118**

Steel carrier rail; 35 x 15 mm; 2.3 mm thick; 2 m long; unslotted; according to EN 60715

[www.wago.com/210-118](http://www.wago.com/210-118)**Item no.: 210-196**

Aluminum carrier rail; 35 x 8.2 mm; 1.6 mm thick; 2 m long; unslotted; similar to EN 60715; silver-colored

[www.wago.com/210-196](http://www.wago.com/210-196)**Item no.: 210-197**

Steel carrier rail; 35 x 15 mm; 1.5 mm thick; 2 m long; slotted; similar to EN 60715

[www.wago.com/210-197](http://www.wago.com/210-197)**Item no.: 210-198**

Copper carrier rail; 35 x 15 mm; 2.3 mm thick; 2 m long; unslotted; according to EN 60715; copper-colored

[www.wago.com/210-198](http://www.wago.com/210-198)**Item no.: 210-504**

Steel carrier rail; 35 x 7.5 mm; 1 mm thick; 2 m long; slotted; galvanized; according to EN 60715

[www.wago.com/210-504](http://www.wago.com/210-504)**Item no.: 210-505**

Steel carrier rail; 35 x 7.5 mm; 1 mm thick; 2 m long; unslotted; galvanized; according to EN 60715

[www.wago.com/210-505](http://www.wago.com/210-505)**Item no.: 210-506**

Steel carrier rail; 35 x 15 mm; 1.5 mm thick; 2 m long; unslotted; galvanized; similar to EN 60715

[www.wago.com/210-506](http://www.wago.com/210-506)**Item no.: 210-508**

Steel carrier rail; 35 x 15 mm; 1.5 mm thick; 2 m long; slotted; galvanized; similar to EN 60715

[www.wago.com/210-508](http://www.wago.com/210-508)

---

**system box**

---

**Item no.: 850-804**

IP65 enclosure; Stainless steel; WxHxD (400x123x200 mm); 4 x M20, 16 x M16, 28 x M12 cable grip

[www.wago.com/850-804](http://www.wago.com/850-804)**Item no.: 850-804/000-001**

IP65 enclosure; Stainless steel; WxHxD (400x123x200 mm); 2 x M20, 13 x M16, 32 x M12 cable grip

[www.wago.com/850-804/000-001](http://www.wago.com/850-804/000-001)**Item no.: 850-805**

IP65 enclosure; Stainless steel; WxHxD (600x123x200 mm); 4 x M20, 19 x M16, 67 x M12 cable grip

[www.wago.com/850-805](http://www.wago.com/850-805)

Subject to changes. Please also observe the further product documentation!

WAGO Kontakttechnik GmbH &amp; Co. KG

Hansastr. 27













32423 Minden

Phone: +49571 887-0 | Fax: +49571 887-169

Email: [info.de@wago.com](mailto:info.de@wago.com) | Web: [www.wago.com](http://www.wago.com)

Do you have any questions about our products?





We are always happy to take your call at +49 (571) 887-44222.

	<b>Item no.: 850-814/002-000</b> IP65 enclosure; Sheet steel (RAL 7035); WxHxD (200x120x200 mm); without flange plate	<a href="http://www.wago.com/850-814/002-000">www.wago.com/850-814/002-000</a>
	<b>Item no.: 850-815/002-000</b> IP65 enclosure; Sheet steel (RAL 7035); WxHxD (300x120x200 mm); without flange plate	<a href="http://www.wago.com/850-815/002-000">www.wago.com/850-815/002-000</a>
	<b>Item no.: 850-816/002-000</b> IP65 enclosure; Sheet steel (RAL 7035); WxHxD (400x120x200 mm); without flange plate	<a href="http://www.wago.com/850-816/002-000">www.wago.com/850-816/002-000</a>
	<b>Item no.: 850-817/002-000</b> IP65 enclosure; Sheet steel (RAL 7035); WxHxD (600x120x200 mm); without flange plate	<a href="http://www.wago.com/850-817/002-000">www.wago.com/850-817/002-000</a>
	<b>Item no.: 850-825</b> IP65 enclosure; Aluminium (RAL 7032); WxHxD (160x100x160 mm); 9 x M12, 4 x M20	<a href="http://www.wago.com/850-825">www.wago.com/850-825</a>
	<b>Item no.: 850-826</b> IP65 enclosure; Aluminium (RAL 7032); WxHxD (240x100x160 mm); 4 x M20, 4 x M16, 14 x M12 cable grip	<a href="http://www.wago.com/850-826">www.wago.com/850-826</a>
	<b>Item no.: 850-826/002-000</b> IP65 enclosure; Aluminium (RAL 7035); WxHxD (240x100x160 mm); 4 x M20, 4 x M16, 14 x M12 cable grip	<a href="http://www.wago.com/850-826/002-000">www.wago.com/850-826/002-000</a>
	<b>Item no.: 850-827</b> IP65 enclosure; Aluminium (RAL 7032); WxHxD (320x100x160 mm); 4 x M20, 8 x M16, 17 x M12 cable grip	<a href="http://www.wago.com/850-827">www.wago.com/850-827</a>
	<b>Item no.: 850-827/002-000</b> IP65 enclosure; Aluminium (RAL 7035); WxHxD (320x100x160 mm); 4 x M20, 8 x M16, 17 x M12 cable grip	<a href="http://www.wago.com/850-827/002-000">www.wago.com/850-827/002-000</a>
	<b>Item no.: 850-828</b> IP65 enclosure; Aluminium (RAL 7032); WxHxD (480x100x160 mm); 4 x M20, 10 x M16, 35 x M12 cable grip	<a href="http://www.wago.com/850-828">www.wago.com/850-828</a>
	<b>Item no.: 850-828/002-000</b> IP65 enclosure; Aluminium (RAL 7035); WxHxD (480x100x160 mm); 4 x M20, 10 x M16, 35 x M12 cable grip	<a href="http://www.wago.com/850-828/002-000">www.wago.com/850-828/002-000</a>
	<b>Item no.: 850-834</b> IP65 enclosure; Polyester (RAL 7032); WxHxD (164x100x164 mm); 9 x M12, 4 x M20	<a href="http://www.wago.com/850-834">www.wago.com/850-834</a>
	<b>Item no.: 850-835</b> IP65 enclosure; Polyester (RAL 7032); WxHxD (244x100x164 mm); 4 x M20, 4 x M16, 14 x M12 cable grip	<a href="http://www.wago.com/850-835">www.wago.com/850-835</a>
	<b>Item no.: 850-836</b> IP65 enclosure; Polyester (RAL 7032); WxHxD (324x100x164 mm); 4 x M20, 8 x M16, 17 x M12 cable grip	<a href="http://www.wago.com/850-836">www.wago.com/850-836</a>

**shield connection**

**Item no.: 790-108**





Subject to changes. Please also observe the further product documentation!

	Shield clamping saddle; 11 mm wide; diameter of compatible conductor; 3 ... 8 mm	<a href="http://www.wago.com/790-108">www.wago.com/790-108</a>
	<b>Item no.: 790-116</b> Shield clamping saddle; 19 mm wide; diameter of compatible conductor; 7 ... 16 mm	<a href="http://www.wago.com/790-116">www.wago.com/790-116</a>
	<b>Item no.: 790-124</b> Shield clamping saddle; 27 mm wide; diameter of compatible conductor; 6 ... 24 mm	<a href="http://www.wago.com/790-124">www.wago.com/790-124</a>
	<b>Item no.: 790-140</b> Shield clamping saddle; diameter of compatible conductor	<a href="http://www.wago.com/790-140">www.wago.com/790-140</a>
	<b>Item no.: 790-208</b> Shield clamping saddle; 12.4 mm wide; 3 ... 8 mm	<a href="http://www.wago.com/790-208">www.wago.com/790-208</a>
	<b>Item no.: 790-216</b> Shield clamping saddle; 21.8 mm wide; 6 ... 16 mm	<a href="http://www.wago.com/790-216">www.wago.com/790-216</a>
	<b>Item no.: 790-220</b> Shield clamping saddle; 30 mm wide; 6 ... 20 mm	<a href="http://www.wago.com/790-220">www.wago.com/790-220</a>











**General accessories**

	<b>Item no.: 750-921</b> Bluetooth® Adapter; light gray	<a href="http://www.wago.com/750-921">www.wago.com/750-921</a>
	<b>Item no.: 750-923</b> Configuration cable; USB connector; Length: 2.5 m; black	<a href="http://www.wago.com/750-923">www.wago.com/750-923</a>
	<b>Item no.: 750-923/000-001</b> Configuration cable; USB connector; Length: 5 m	<a href="http://www.wago.com/750-923/000-001">www.wago.com/750-923/000-001</a>

**Marking accessories**

	<b>Item no.: 2009-145</b> Mini-WSB Inline; for Smart Printer; 1700 pieces on roll; stretchable 5 - 5.2 mm; plain; snap-on type; white	<a href="http://www.wago.com/2009-145">www.wago.com/2009-145</a>
	<b>Item no.: 2009-145/000-002</b> Mini-WSB Inline; for Smart Printer; 1700 pieces on roll; stretchable 5 - 5.2 mm; plain; snap-on type; white /000-002	<a href="http://www.wago.com/2009-145/000-002">www.wago.com/2009-145/000-002</a>
	<b>Item no.: 2009-145/000-005</b> Mini-WSB Inline; for Smart Printer; 1700 pieces on roll; stretchable 5 - 5.2 mm; plain; snap-on type; red /000-005	<a href="http://www.wago.com/2009-145/000-005">www.wago.com/2009-145/000-005</a>
	<b>Item no.: 2009-145/000-006</b> Mini-WSB Inline; for Smart Printer; 1700 pieces on roll; stretchable 5 - 5.2 mm; plain; snap-on type; blue /000-006	<a href="http://www.wago.com/2009-145/000-006">www.wago.com/2009-145/000-006</a>
	<b>Item no.: 2009-145/000-007</b> Mini-WSB Inline; for Smart Printer; 1700 pieces on roll; stretchable 5 - 5.2 mm; plain; snap-on type; white /000-007	<a href="http://www.wago.com/2009-145/000-007">www.wago.com/2009-145/000-007</a>

Subject to changes. Please also observe the further product documentation!

	<p><b>Item no.: 2009-145/000-012</b>                  Mini-WSB Inline; for Smart Printer; 1700 pieces on roll; stretchable 5 - 5.2 mm; plain; snap-on type; orange</p>	<a href="http://www.wago.com/2009-145/000-012">www.wago.com/2009-145/000-012</a>
	<p><b>Item no.: 2009-145/000-023</b>                  Mini-WSB Inline; for Smart Printer; 1700 pieces on roll; stretchable 5 - 5.2 mm; plain; snap-on type; green</p>	<a href="http://www.wago.com/2009-145/000-023">www.wago.com/2009-145/000-023</a>
	<p><b>Item no.: 2009-145/000-024</b>                  Mini-WSB Inline; for Smart Printer; 1700 pieces on roll; stretchable 5 - 5.2 mm; plain; snap-on type; violet</p>	<a href="http://www.wago.com/2009-145/000-024">www.wago.com/2009-145/000-024</a>
	<p><b>Item no.: 248-501</b>                  Miniature WSB Quick marking system; plain; Marker width 5 mm; 10 strips with 10 markers per card</p>	<a href="http://www.wago.com/248-501">www.wago.com/248-501</a>
	<p><b>Item no.: 248-501/000-002</b>                  Mini-WSB marking card; as card; not stretchable; plain; snap-on type; yellow</p>	<a href="http://www.wago.com/248-501/000-002">www.wago.com/248-501/000-002</a>
	<p><b>Item no.: 248-501/000-005</b>                  Mini-WSB marking card; as card; not stretchable; plain; snap-on type; red</p>	<a href="http://www.wago.com/248-501/000-005">www.wago.com/248-501/000-005</a>
	<p><b>Item no.: 248-501/000-006</b>                  Mini-WSB marking card; as card; not stretchable; plain; snap-on type; blue</p>	<a href="http://www.wago.com/248-501/000-006">www.wago.com/248-501/000-006</a>
	<p><b>Item no.: 248-501/000-007</b>                  Mini-WSB marking card; as card; not stretchable; plain; snap-on type; gray</p>	<a href="http://www.wago.com/248-501/000-007">www.wago.com/248-501/000-007</a>
	<p><b>Item no.: 248-501/000-012</b>                  Mini-WSB marking card; as card; not stretchable; plain; snap-on type; orange</p>	<a href="http://www.wago.com/248-501/000-012">www.wago.com/248-501/000-012</a>
	<p><b>Item no.: 248-501/000-017</b>                  Mini-WSB marking card; as card; not stretchable; plain; snap-on type; light green</p>	<a href="http://www.wago.com/248-501/000-017">www.wago.com/248-501/000-017</a>
	<p><b>Item no.: 248-501/000-023</b>                  Mini-WSB marking card; as card; not stretchable; plain; snap-on type; green</p>	<a href="http://www.wago.com/248-501/000-023">www.wago.com/248-501/000-023</a>
	<p><b>Item no.: 248-501/000-024</b>                  Mini-WSB marking card; as card; not stretchable; plain; snap-on type; violet</p>	<a href="http://www.wago.com/248-501/000-024">www.wago.com/248-501/000-024</a>
	<p><b>Item no.: 750-103</b>                  Group marker carrier; transparent</p>	<a href="http://www.wago.com/750-103">www.wago.com/750-103</a>
	<p><b>Item no.: 750-107</b>                  Group marker carrier; transparent</p>	<a href="http://www.wago.com/750-107">www.wago.com/750-107</a>

Subject to changes. Please also observe the further product documentation!



## Downloads

### Documentation

#### Manual

WAGO MODBUS Master Configurator for configuration of MODBUS networks in WAGO-I/O-PRO (CODESYS)	V 1.1.0	pdf 1.8 MB	Download
---------------------------------------------------------------------------------------------------	---------	---------------	----------

ETHERNET Controller /XTR for eXTReme environmental conditions; 32-bit CPU, multitasking	V 1.2.0	pdf 13.8 MB	Download
--------------------------------------------------------------------------------------------	---------	----------------	----------

#### Additional Information

Disposal; Electrical and electronic equipment, Packaging	V 1.0.0	pdf 265.8 kB	Download
----------------------------------------------------------	---------	-----------------	----------

#### System Description

System Manual /XTR Basic conditions and recommendations for higher operational safety	V 1.2.0	pdf 2.9 MB	Download
------------------------------------------------------------------------------------------	---------	---------------	----------

750 XTR Controller, General Product Information		pdf 517.0 kB	Download
-------------------------------------------------	--	-----------------	----------

## Engineering-Software

### Configuration and Commissioning Software

(759-316) WAGO Ethernet Settings / Serie 750	6.10.06.12 Mar 29, 2019	exe 20.2 MB	Download
----------------------------------------------	----------------------------	----------------	----------

WAGO BootPServer / Serie 750 und 767	1.0 Mar 7, 2000	zip 1.1 MB	Download
--------------------------------------	--------------------	---------------	----------

WAGUpload Full Version WAGUpload ist eine eigenständige PC-Software zur Übertragung, Sicherung und Wiederherstellung von SPS-Applikationen auf WAGO Controllern der Serie 750.	1.12.0.0 Mar 30, 2020	zip 55.2 MB	Download
-----------------------------------------------------------------------------------------------------------------------------------------------------------------------------------	--------------------------	----------------	----------

WAGUpload Small Version WAGUpload ist eine eigenständige PC-Software zur Übertragung, Sicherung und Wiederherstellung von SPS-Applikationen auf WAGO Controllern der Serie 750	1.12.0.0 Mar 30, 2020	zip 5.6 MB	Download
-----------------------------------------------------------------------------------------------------------------------------------------------------------------------------------	--------------------------	---------------	----------

Subject to changes. Please also observe the further product documentation!



## Runtime Software

### Firmware

Firmware: 750-880/040-000 Controller ETHERNET; 3rd Generation; SD Card Slot; Extreme; dark gray	14 Apr 11, 2019	zip 5.9 MB	Download
-------------------------------------------------------------------------------------------------	--------------------	---------------	----------

## CAD/CAE-Data

### CAD data

2D/3D Models 750-880/040-000		URL	Download
------------------------------	--	-----	----------

### CAE data

EPLAN Data Portal 750-880/040-000		URL	Download
-----------------------------------	--	-----	----------

WSCAD Universe 750-880/040-000		URL	Download
--------------------------------	--	-----	----------

## Device Files

### Device Description File

750-915; EDS-Dateien für EthernetIP / Serie 750 und 767	11 Nov 12, 2019	zip 93.6 kB	Download
---------------------------------------------------------	--------------------	----------------	----------

MIB-Datei für Ethernet-Controller / Serie 750	2.0 Apr 3, 2012	zip 6.1 kB	Download
-----------------------------------------------	--------------------	---------------	----------

### Device Driver

WAGO USB Service Kabel Treiber / Serie 750 und 857	6.5.3.0 Sep 10, 2014	zip 4.8 MB	Download
----------------------------------------------------	-------------------------	---------------	----------

## Installation Notes

## Product family

### Controller 750 XTR

[Learn more about the product family.](#)

[Show all products from the family](#)

Subject to changes. Please also observe the further product documentation!