

Data sheet | Item number: 750-486

4-channel analog input; 0/4 ... 20 mA; Single-ended; NAMUR NE 43;  
Intrinsically safe; blue

[www.wago.com/750-486](http://www.wago.com/750-486)

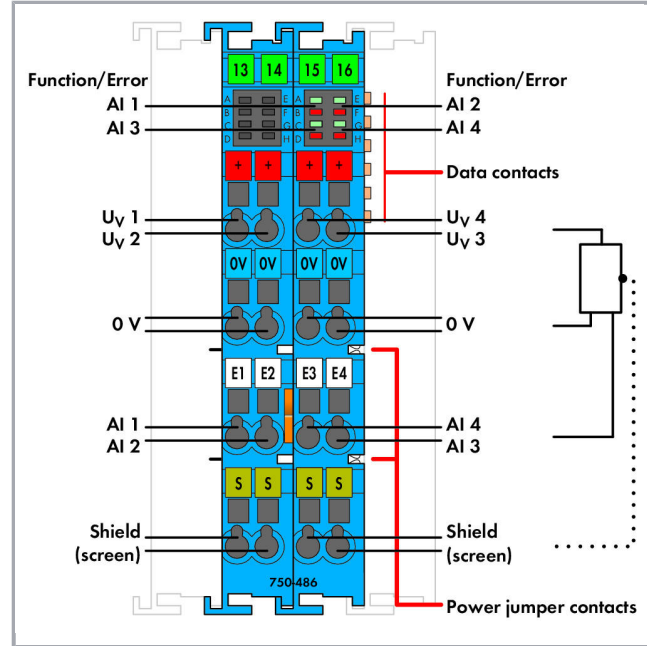

RoHS  Compliant

BOMcheck.net

Color: ■

Subject to changes. Please also observe the further product documentation!

WAGO Kontakttechnik GmbH & Co. KG  
Hansastr. 27  
32423 Minden  
Phone: +49571 887-0 | Fax: +49571 887-169  
Email: [info.de@wago.com](mailto:info.de@wago.com) | Web: [www.wago.com](http://www.wago.com)

Do you have any questions about our products?  
We are always happy to take your call at +49 (571) 887-44222.

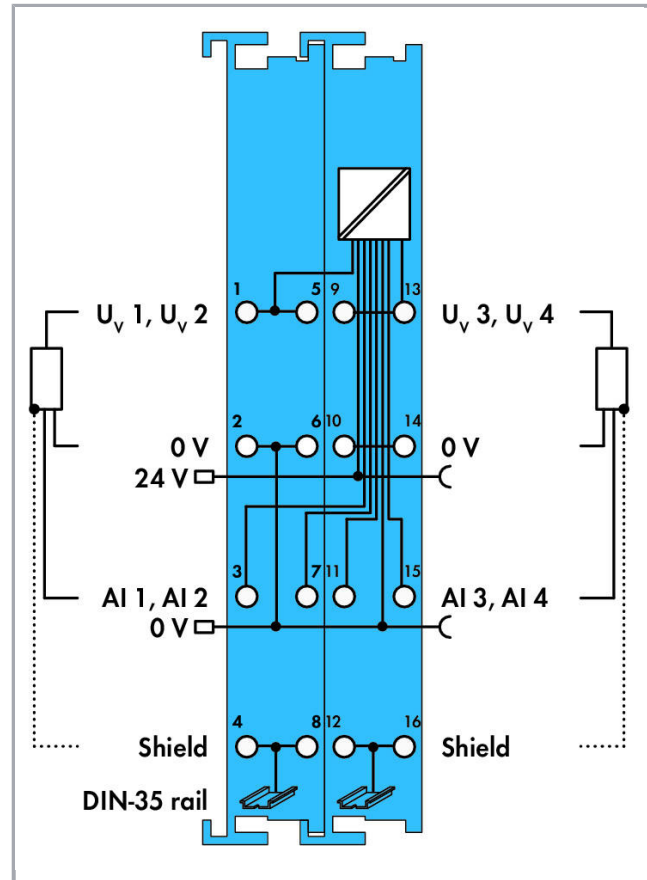
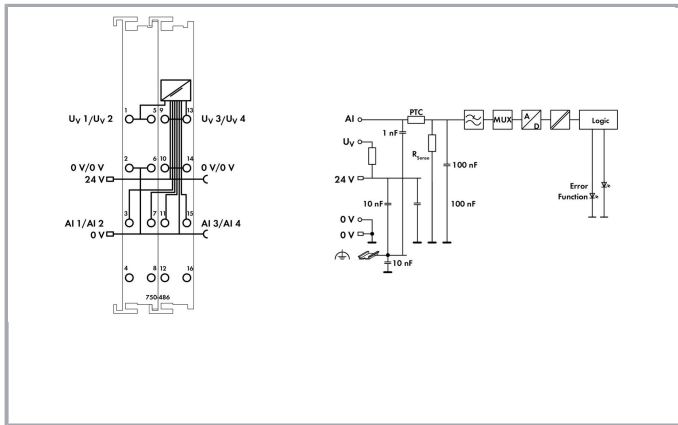

## Item description

This analog input module powers the intrinsically safe signal conditioners located in the hazardous areas of Zone 0+1 and processes their analog signals.

The WAGO I/O System 750 must be installed either in Zone 2 or in a non-hazardous area.

The 24 V supply is derived from the module's power jumper contacts.

The transmitter supply is non-inherently electronically short-circuit-protected.

The shield directly connects to the DIN-rail.

Indicators:

- Green LED (availability ON/OFF)
- Red LED (measurement range overflow/underflow, wire breakage, short circuit)

Field and system levels are electrically isolated.

Subject to changes. Please also observe the further product documentation!

**Note:**

The analog output module must only be operated via 24 VDC Ex II!

General information (e.g., installation regulations) on explosion protection is available in the WAGO I/O System 750 manuals!

**Data****Technical Data**

Number of analog inputs	4
Total number of channels (module)	4
Type of signal	Electricity
Type of signal current	DC 0 ... 20 mA; DC 4 ... 20 mA
Sensor connection	2 x (3-wire)
Resolution [bit]	12 Bit
Input resistance max.	200 Ω
Power consumption $P_{max}$	2.7 W
Bit width	4 x 16-bit data; 4 x 8-bit control/status (optional)
Conversion time (typ. ≤)	10 ms
Messfehler, Bezugstemperatur	25 °C
Messfehler, Abweichung max. vom Messbereichsendwert	0.1 %
Temperaturfehler max. vom Messbereichsendwert	0.01 %/K
Intrinsic safety Ex i	yes
System supply voltage	DC 5 V; via data contacts
Current consumption, system supply (5 V)	45 mA
Field supply voltage	DC 24 V; (Ex i power supply: $U_O = \max. 27.3 \text{ V}$ ); via power jumper contacts (power supply via blade contact; transmission via spring contact)
Current consumption, field supply (module with no external load)	19 mA
Power loss $P_V$	1.5 W
Isolation	300 VAC system/field
Number of incoming power jumper contacts	2
Number of outgoing power jumper contacts	2
Current carrying capacity of the power jumper contacts	1 A
Ex guideline	EN/IEC 60079-0, -7, -11, -26, -31
Electric circuit, safety-relevant data	$U_O = 27.3 \text{ V}$ ; $I_O = 98.4 \text{ mA}$ ; $P_O = 0.672 \text{ W}$ ; Linear characteristic curve
Reactances Ex ia IIC	$L_O = 970 \mu\text{H}$ ; $C_O = 88 \text{ nF}$

Subject to changes. Please also observe the further product documentation!



Reactances Ex ia IIB	$L_o = 13 \text{ mH}; C_o = 683 \text{ nF}$
Ex ia IIA reactances	$L_o = 22 \text{ mH}; C_o = 2.28 \text{ }\mu\text{F}$
Reactances Ex ia I	$L_o = 31 \text{ mH}; C_o = 3.6 \text{ }\mu\text{F}$
Reactances	Reactances without accounting for the concurrence of L and C
Marking	ATEX, IECEx

### Connection data

Connection technology: In-/Outputs	16 x CAGE CLAMP®
Connection type (1)	Inputs/Outputs
Solid conductor	0,08 ... 2,5 mm <sup>2</sup> / 28 ... 14 AWG
Fine-stranded conductor	0,08 ... 2,5 mm <sup>2</sup> / 28 ... 14 AWG
Strip length	8 ... 9 mm / 0.31 ... 0.35 inch

### Geometrical Data

Width	24 mm / 0.945 inch
Height	67,8 mm / 2.669 inch
Height from upper-edge of DIN-35 rail	60,6 mm / 2.386 inch
Depth	100 mm / 3.937 inch

### Mechanical data

Type of mounting	DIN-35 rail
------------------	-------------

### Material Data

Color	blue
Housing material	Polycarbonate, polyamide 6.6
Weight	116 g
Conformity marking	CE

### Environmental Requirements

Surrounding air (operating) temperature	0 ... 55 °C
Surrounding air (storage) temperature	-40 ... 85 °C
Protection class	IP20
Degree of pollution (5)	2 per IEC 61131-2
Operating altitude	0 ... 2000 m
Mounting position	horizontal (standing/lying); vertical

Subject to changes. Please also observe the further product documentation!



Relative air humidity (no condensation)	95 %
Vibration resistance	per IEC 60068-2-6
Shock resistance	15g per IEC 60068-2-27
EMC immunity to interference	per EN 61000-6-2, marine applications
EMC emission of interference	per EN 61000-6-3, marine applications
Exposure to pollutants	Per IEC 60068-2-42 and IEC 60068-2-43
Permissible H <sub>2</sub> S contaminant concentration at a relative humidity 75 %	10 ppm
Permissible SO <sub>2</sub> contaminant concentration at a relative humidity 75 %	25 ppm

### Commercial data

Packaging type	BOX
Country of origin	DE
GTIN	4055143516044
Customs Tariff No.	85389099990

### Approvals / Certificates

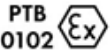
#### Ex-Approvals

Logo	Approval	Additional Approval Text	Certificate name
	<b>ATEX</b> TUEV Nord Cert GmbH	EN 60079-0	TUEV_12_ATEX_106032X
	<b>INMETRO</b> TÜV Rheinland do Brasil Ltda.	-	TÜV_14.1911_X
	<b>TUEV Nord</b> TUEV Nord Cert GmbH	IEC 60079, IEC 60079-0	IECEX TUN 12.0039X
	<b>UL</b> Underwriters Laboratories Inc. (HAZARDOUS LOCATIONS)	UL 121201	E198726 Sec.1





#### Country specific Approvals

Logo	Approval	Additional Approval Text	Certificate name
	<b>KC</b> National Radio Research Agency	Article 58-2, Clause 3	MSIP-REM-W43-

Subject to changes. Please also observe the further product documentation!



## Ship Approvals

Logo	Approval	Additional Approval Text	Certificate name
	<b>ABS</b> American Bureau of Shipping	-	19- HG1821926
	<b>DNV GL</b> Det Norske Veritas, Germanischer Lloyd	-	TAA0000194
	<b>LR</b> Lloyds Register	-	02/20026 (E6)
	<b>PRS</b> Polski Rejestr Statków	-	TE/2236 /880590/19
	<b>RINA</b> RINA Germany GmbH	-	ELE066419XG

## UL-Approvals

Logo	Approval	Additional Approval Text	Certificate name
	<b>UL</b> Underwriters Laboratories Inc. (ORDINARY LOCATIONS)	UL 61010-2-201	E175199 Sec10

## Counterpart





Subject to changes. Please also observe the further product documentation!

WAGO Kontakttechnik GmbH & Co. KG  
 Hansastr. 27  
 32423 Minden  
 Phone: +49571 887-0 | Fax: +49571 887-169  
 Email: [info.de@wago.com](mailto:info.de@wago.com) | Web: [www.wago.com](http://www.wago.com)

Do you have any questions about our products?  
 We are always happy to take your call at +49 (571) 887-44222.

## Compatible products

### Marking accessories

	<b>Item no.: 2009-145</b> Mini-WSB Inline; for Smart Printer; 1700 pieces on roll; stretchable 5 - 5.2 mm; plain; snap-on type; white	<a href="http://www.wago.com/2009-145">www.wago.com/2009-145</a>
	<b>Item no.: 2009-145/000-002</b> Mini-WSB Inline; for Smart Printer; 1700 pieces on roll; stretchable 5 - 5.2 mm; plain; snap-on type; white	<a href="http://www.wago.com/2009-145/000-002">www.wago.com/2009-145/000-002</a>
	<b>Item no.: 2009-145/000-005</b> Mini-WSB Inline; for Smart Printer; 1700 pieces on roll; stretchable 5 - 5.2 mm; plain; snap-on type; red	<a href="http://www.wago.com/2009-145/000-005">www.wago.com/2009-145/000-005</a>
	<b>Item no.: 2009-145/000-006</b> Mini-WSB Inline; for Smart Printer; 1700 pieces on roll; stretchable 5 - 5.2 mm; plain; snap-on type; blue	<a href="http://www.wago.com/2009-145/000-006">www.wago.com/2009-145/000-006</a>
	<b>Item no.: 2009-145/000-007</b> Mini-WSB Inline; for Smart Printer; 1700 pieces on roll; stretchable 5 - 5.2 mm; plain; snap-on type; white	<a href="http://www.wago.com/2009-145/000-007">www.wago.com/2009-145/000-007</a>
	<b>Item no.: 2009-145/000-012</b> Mini-WSB Inline; for Smart Printer; 1700 pieces on roll; stretchable 5 - 5.2 mm; plain; snap-on type; orange	<a href="http://www.wago.com/2009-145/000-012">www.wago.com/2009-145/000-012</a>
	<b>Item no.: 2009-145/000-023</b> Mini-WSB Inline; for Smart Printer; 1700 pieces on roll; stretchable 5 - 5.2 mm; plain; snap-on type; green	<a href="http://www.wago.com/2009-145/000-023">www.wago.com/2009-145/000-023</a>
	<b>Item no.: 2009-145/000-024</b> Mini-WSB Inline; for Smart Printer; 1700 pieces on roll; stretchable 5 - 5.2 mm; plain; snap-on type; violet	<a href="http://www.wago.com/2009-145/000-024">www.wago.com/2009-145/000-024</a>
	<b>Item no.: 248-501</b> Miniature WSB Quick marking system; plain; Marker width 5 mm; 10 strips with 10 markers per card	<a href="http://www.wago.com/248-501">www.wago.com/248-501</a>
	<b>Item no.: 248-501/000-002</b> Mini-WSB marking card; as card; not stretchable; plain; snap-on type; yellow	<a href="http://www.wago.com/248-501/000-002">www.wago.com/248-501/000-002</a>
	<b>Item no.: 248-501/000-005</b> Mini-WSB marking card; as card; not stretchable; plain; snap-on type; red	<a href="http://www.wago.com/248-501/000-005">www.wago.com/248-501/000-005</a>
	<b>Item no.: 248-501/000-006</b> Mini-WSB marking card; as card; not stretchable; plain; snap-on type; blue	<a href="http://www.wago.com/248-501/000-006">www.wago.com/248-501/000-006</a>

Subject to changes. Please also observe the further product documentation!

**Item no.: 248-501/000-007**

Mini-WSB marking card; as card; not stretchable; plain; snap-on type; gray

[www.wago.com/248-501/000-007](http://www.wago.com/248-501/000-007)**Item no.: 248-501/000-012**

Mini-WSB marking card; as card; not stretchable; plain; snap-on type; orange

[www.wago.com/248-501/000-012](http://www.wago.com/248-501/000-012)**Item no.: 248-501/000-017**

Mini-WSB marking card; as card; not stretchable; plain; snap-on type; light green

[www.wago.com/248-501/000-017](http://www.wago.com/248-501/000-017)**Item no.: 248-501/000-023**

Mini-WSB marking card; as card; not stretchable; plain; snap-on type; green

[www.wago.com/248-501/000-023](http://www.wago.com/248-501/000-023)**Item no.: 248-501/000-024**

Mini-WSB marking card; as card; not stretchable; plain; snap-on type; violet

[www.wago.com/248-501/000-024](http://www.wago.com/248-501/000-024)**Item no.: 750-103**

Group marker carrier; transparent

[www.wago.com/750-103](http://www.wago.com/750-103)**Item no.: 750-107**

Group marker carrier; transparent

[www.wago.com/750-107](http://www.wago.com/750-107)**shield connection****Item no.: 790-108**

Shield clamping saddle; 11 mm wide; diameter of compatible conductor; 3 ... 8 mm

[www.wago.com/790-108](http://www.wago.com/790-108)**Item no.: 790-116**

Shield clamping saddle; 19 mm wide; diameter of compatible conductor; 7 ... 16 mm

[www.wago.com/790-116](http://www.wago.com/790-116)**Item no.: 790-124**

Shield clamping saddle; 27 mm wide; diameter of compatible conductor; 6 ... 24 mm

[www.wago.com/790-124](http://www.wago.com/790-124)**Item no.: 790-140**

Shield clamping saddle; diameter of compatible conductor

[www.wago.com/790-140](http://www.wago.com/790-140)**Item no.: 790-208**

Shield clamping saddle; 12.4 mm wide; 3 ... 8 mm

[www.wago.com/790-208](http://www.wago.com/790-208)**Item no.: 790-216**

Shield clamping saddle; 21.8 mm wide; 6 ... 16 mm

[www.wago.com/790-216](http://www.wago.com/790-216)**Item no.: 790-220**

Shield clamping saddle; 30 mm wide; 6 ... 20 mm

[www.wago.com/790-220](http://www.wago.com/790-220)**Supply module**

Subject to changes. Please also observe the further product documentation!

WAGO Kontakttechnik GmbH &amp; Co. KG

Hansastr. 27

32423 Minden

Phone: +49571 887-0 | Fax: +49571 887-169

Email: [info.de@wago.com](mailto:info.de@wago.com) | Web: [www.wago.com](http://www.wago.com)

Do you have any questions about our products?

We are always happy to take your call at +49 (571) 887-44222.



**Item no.: 750-606**  
Power Supply; 24 VDC; Diagnostics; Intrinsically safe; light gray

[www.wago.com/750-606](http://www.wago.com/750-606)



**Item no.: 750-625/000-001**  
Power Supply; 24 VDC; Intrinsically safe; light gray

[www.wago.com/750-625/000-001](http://www.wago.com/750-625/000-001)

**Carrier rail**

**Item no.: 210-112**  
Steel carrier rail; 35 x 7.5 mm; 1 mm thick; 2 m long; slotted; according to EN 60715; "Hole width 25 mm" [www.wago.com/210-112](http://www.wago.com/210-112)

**Item no.: 210-113**  
Steel carrier rail; 35 x 7.5 mm; 1 mm thick; 2 m long; unslotted; according to EN 60715 [www.wago.com/210-113](http://www.wago.com/210-113)

**Item no.: 210-114**  
Steel carrier rail; 35 x 15 mm; 1.5 mm thick; 2 m long; unslotted; similar to EN 60715 [www.wago.com/210-114](http://www.wago.com/210-114)

**Item no.: 210-115**  
Steel carrier rail; 35 x 7.5 mm; 1 mm thick; 2 m long; slotted; according to EN 60715; "Hole width 18 mm" [www.wago.com/210-115](http://www.wago.com/210-115)



**Item no.: 210-118**  
Steel carrier rail; 35 x 15 mm; 2.3 mm thick; 2 m long; unslotted; according to EN 60715 [www.wago.com/210-118](http://www.wago.com/210-118)

**Item no.: 210-196**  
Aluminum carrier rail; 35 x 8.2 mm; 1.6 mm thick; 2 m long; unslotted; similar to EN 60715; silver-colored [www.wago.com/210-196](http://www.wago.com/210-196)

**Item no.: 210-197**  
Steel carrier rail; 35 x 15 mm; 1.5 mm thick; 2 m long; slotted; similar to EN 60715 [www.wago.com/210-197](http://www.wago.com/210-197)



**Item no.: 210-198**  
Copper carrier rail; 35 x 15 mm; 2.3 mm thick; 2 m long; unslotted; according to EN 60715; copper-colored [www.wago.com/210-198](http://www.wago.com/210-198)

**Item no.: 210-504**  
Steel carrier rail; 35 x 7.5 mm; 1 mm thick; 2 m long; slotted; galvanized; according to EN 60715 [www.wago.com/210-504](http://www.wago.com/210-504)

**Item no.: 210-505**  
Steel carrier rail; 35 x 7.5 mm; 1 mm thick; 2 m long; unslotted; galvanized; according to EN 60715 [www.wago.com/210-505](http://www.wago.com/210-505)

**Item no.: 210-506**  
Steel carrier rail; 35 x 15 mm; 1.5 mm thick; 2 m long; unslotted; galvanized; similar to EN 60715 [www.wago.com/210-506](http://www.wago.com/210-506)

**Item no.: 210-508**  
Steel carrier rail; 35 x 15 mm; 1.5 mm thick; 2 m long; slotted; galvanized; similar to EN 60715 [www.wago.com/210-508](http://www.wago.com/210-508)

**Downloads**

**Documentation**

**Data sheet**

750-486, 0/4–20 mA NE43 Ex i, Datasheet

pdf [Download](#)  
240.8 kB

Subject to changes. Please also observe the further product documentation!

WAGO Kontakttechnik GmbH & Co. KG  
Hansastr. 27  
32423 Minden  
Phone: +49571 887-0 | Fax: +49571 887-169  
Email: [info.de@wago.com](mailto:info.de@wago.com) | Web: [www.wago.com](http://www.wago.com)

Do you have any questions about our products?  
We are always happy to take your call at +49 (571) 887-44222.



<b>Manual</b>			
4AI 0/4–20 mA, Ex i	V 1.1.2 Jan 21, 2020	pdf 5.6 MB	Download
<b>Additional Information</b>			
Disposal; Electrical and electronic equipment, Packaging	V 1.0.0	pdf 265.8 kB	Download
<b>System Description</b>			
Overview on WAGO-I/O-SYSTEM 750 approvals		pdf 780.2 kB	Download
Use in Hazardous Environments Term definition, marking and installation regulations	V 1.0.0	pdf 1.0 MB	Download
Design Notes Basic conditions and recommendations for higher operational safety	V 2.0.0	pdf 1.5 MB	Download
750/753 Series I/O-System – General Product Information		pdf 1.7 MB	Download
Ex i Overview		pdf 616.0 kB	Download
<b>CAD/CAE-Data</b>			
<b>CAD data</b>			
2D/3D Models 750-486		URL	Download
<b>CAE data</b>			
EPLAN Data Portal 750-486		URL	Download
WSCAD Universe 750-486		URL	Download

## Installation Notes

Subject to changes. Please also observe the further product documentation!

WAGO Kontakttechnik GmbH & Co. KG  
 Hansastr. 27  
 32423 Minden  
 Phone: +49571 887-0 | Fax: +49571 887-169  
 Email: [info.de@wago.com](mailto:info.de@wago.com) | Web: [www.wago.com](http://www.wago.com)

Do you have any questions about our products?  
 We are always happy to take your call at +49 (571) 887-44222.



## Product family

750/753 Series – I/O System

[Show all products from the family](#)

Subject to changes. Please also observe the further product documentation!

---

WAGO Kontakttechnik GmbH & Co. KG  
Hansastr. 27  
32423 Minden  
Phone: +49571 887-0 | Fax: +49571 887-169  
Email: [info.de@wago.com](mailto:info.de@wago.com) | Web: [www.wago.com](http://www.wago.com)

Do you have any questions about our products?  
We are always happy to take your call at +49 (571) 887-44222.