

Data sheet | Item number: 750-468

4-channel analog input; 0 ... 10 VDC; Single-ended; light gray

[www.wago.com/750-468](http://www.wago.com/750-468)

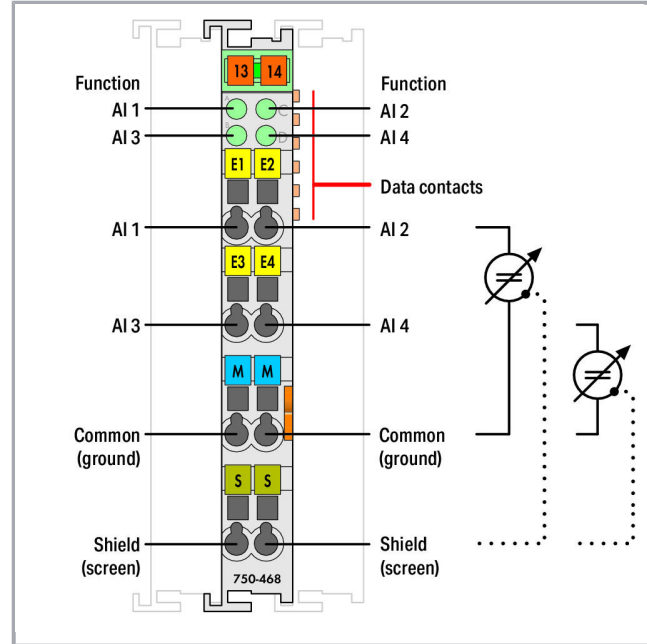

RoHS  Compliant

[BOMcheck.net](https://www.bomcheck.net)

Color:

Subject to changes. Please also observe the further product documentation!

WAGO Kontakttechnik GmbH & Co. KG  
Hansastr. 27  
32423 Minden  
Phone: +49571 887-0 | Fax: +49571 887-169  
Email: [info.de@wago.com](mailto:info.de@wago.com) | Web: [www.wago.com](http://www.wago.com)

Do you have any questions about our products?  
We are always happy to take your call at +49 (571) 887-44222.

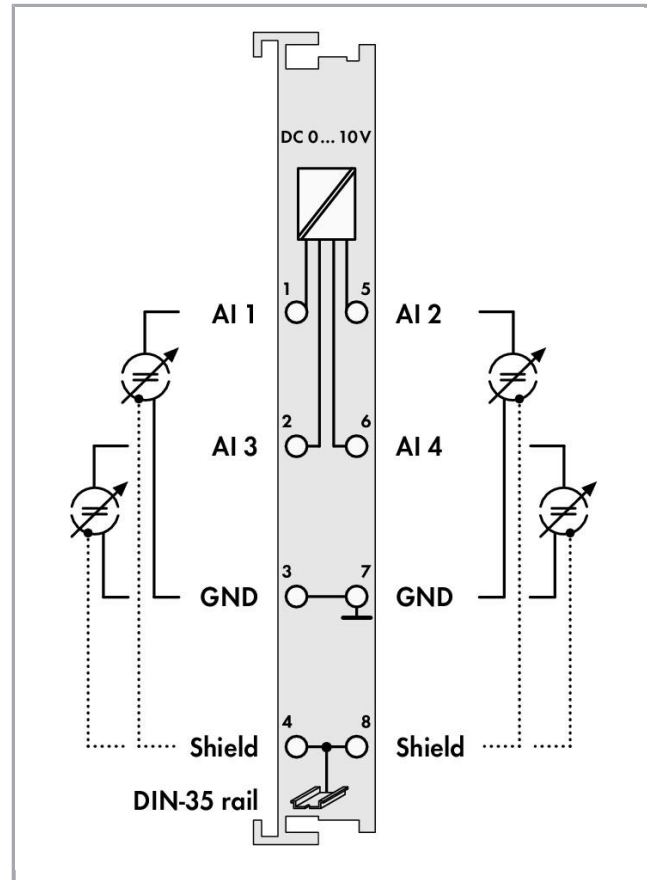
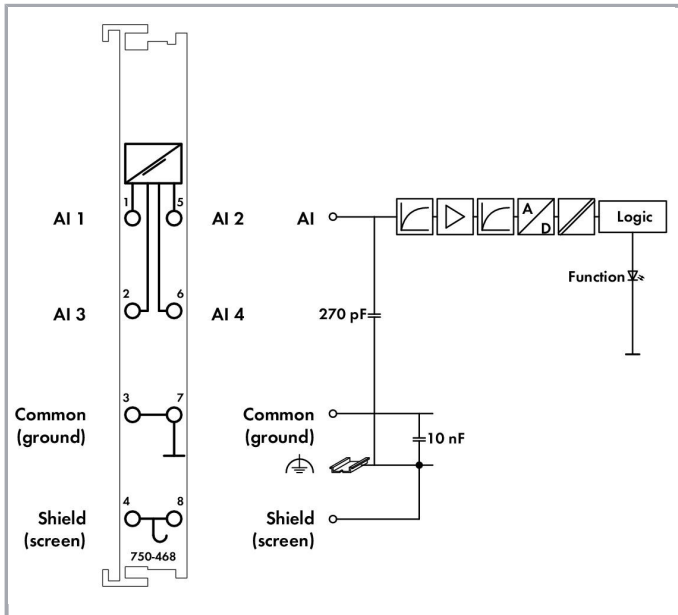

## Item description

This analog input module processes standard 0–10 V signals.

The input signal is electrically isolated and transmitted with a resolution of 12 bits.

The internal system supply powers the module.

The input channels of the module have a common ground potential.

The shield directly connects to the DIN-rail.

## Data

### Technical Data

Number of analog inputs	4
Total number of channels (module)	4
Type of signal	Voltage
Type of signal voltage	DC 0 ... 10 V

Subject to changes. Please also observe the further product documentation!



Sensor connection	4 x (2-wire)
Input voltage (max.)	35 V
Signal characteristic	Single-ended
Resolution [bit]	12 Bit
Bit width	4 x 16-bit data; 4 x 8-bit control/status (optional)
Internal resistance	133 k $\Omega$
Conversion time (typ. $\leq$ )	4 ms
Messfehler, Bezugstemperatur	25 °C
Messfehler, Abweichung max. vom Messbereichsendwert	0.2 %
Temperaturfehler max. vom Messbereichsendwert	0.01 %/K
System supply voltage	DC 5 V; via data contacts
Current consumption, system supply (5 V)	60 mA
Isolation	500 V system/field

### Connection data

Connection technology: In-/Outputs	8 x CAGE CLAMP <sup>®</sup>
Connection type (1)	Inputs/Outputs
Solid conductor	0,08 ... 2,5 mm <sup>2</sup> / 28 ... 14 AWG
Fine-stranded conductor	0,08 ... 2,5 mm <sup>2</sup> / 28 ... 14 AWG
Strip length	8 ... 9 mm / 0.31 ... 0.35 inch

### Geometrical Data

Width	12 mm / 0.472 inch
Height	69,8 mm / 2.748 inch
Height from upper-edge of DIN-35 rail	62,6 mm / 2.465 inch
Depth	100 mm / 3.937 inch

### Mechanical data

Type of mounting	DIN-35 rail
------------------	-------------

### Material Data

Color	light gray
Housing material	Polycarbonate, polyamide 6.6
Weight	50 g
Conformity marking	CE

Subject to changes. Please also observe the further product documentation!

## Environmental Requirements



Surrounding air (operating) temperature	0 ... 55 °C
Surrounding air (storage) temperature	-40 ... 85 °C
Protection class	IP20
Degree of pollution (5)	2 per IEC 61131-2
Operating altitude	0 ... 2000 m
Mounting position	horizontal (standing/lying); vertical
Relative air humidity (no condensation)	95 %
Vibration resistance	4g per IEC 60068-2-6
Shock resistance	15g per IEC 60068-2-27
EMC immunity to interference	per EN 61000-6-2, marine applications
EMC emission of interference	per EN 61000-6-4, marine applications
Exposure to pollutants	Per IEC 60068-2-42 and IEC 60068-2-43
Permissible H <sub>2</sub> S contaminant concentration at a relative humidity 75 %	10 ppm
Permissible SO <sub>2</sub> contaminant concentration at a relative humidity 75 %	25 ppm

## Commercial data

Product Group	15 (Remote I/O)
Packaging type	BOX
Country of origin	DE
GTIN	4045454393045
Customs Tariff No.	85389099990

## Approvals / Certificates

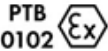
### Ex-Approvals

Logo	Approval	Additional Approval Text	Certificate name
	ATEX TUEV Nord Cert GmbH	EN 60079-0	TÜV 07 ATEX 554086 X en.
	TUEV Nord TUEV Nord Cert GmbH	IEC 60079-0	IECEX TUN 09.0001 X
	UL	UL 121201	E198726

Subject to changes. Please also observe the further product documentation!









Underwriters Laboratories Inc. (HAZARDOUS LOCATIONS)

Sec.1

#### Country specific Approvals

Logo	Approval	Additional Approval Text	Certificate name
	KC National Radio Research Agency	Article 58-2, Clause 3	MSIP- REM-W43- AIM750

#### Ship Approvals

Logo	Approval	Additional Approval Text	Certificate name
	ABS American Bureau of Shipping	-	19- HG1821926
	BV Bureau Veritas S.A.	-	13453/DO BV
	DNV GL Det Norske Veritas, Germanischer Lloyd	-	TAA0000194
	KR Korean Register of Shipping	-	KR HMB05880- AC001
	LR Lloyds Register	-	02/20026 (E6)
	PRS Polski Rejestr Statków	-	TE/2236 /880590/19
	RINA RINA Germany GmbH	-	ELE066419XG

Subject to changes. Please also observe the further product documentation!

WAGO Kontakttechnik GmbH & Co. KG  
Hansastr. 27  
32423 Minden  
Phone: +49571 887-0 | Fax: +49571 887-169  
Email: [info.de@wago.com](mailto:info.de@wago.com) | Web: [www.wago.com](http://www.wago.com)

Do you have any questions about our products?  
We are always happy to take your call at +49 (571) 887-44222.



## UL-Approvals

Logo	Approval	Additional Approval Text	Certificate name
	<b>UL</b> UL International Netherlands B.V. (ORDINARY LOCATIONS)	UL 508	E175199 Sec.1









## Counterpart

## Compatible products

## system box

	<b>Item no.: 850-804</b> IP65 enclosure; Stainless steel; WxHxD (400x123x200 mm); 4 x M20, 16 x M16, 28 x M12 cable grip	<a href="http://www.wago.com/850-804">www.wago.com/850-804</a>
	<b>Item no.: 850-804/000-001</b> IP65 enclosure; Stainless steel; WxHxD (400x123x200 mm); 2 x M20, 13 x M16, 32 x M12 cable grip	<a href="http://www.wago.com/850-804/000-001">www.wago.com/850-804/000-001</a>
	<b>Item no.: 850-805</b> IP65 enclosure; Stainless steel; WxHxD (600x123x200 mm); 4 x M20, 19 x M16, 67 x M12 cable grip	<a href="http://www.wago.com/850-805">www.wago.com/850-805</a>
	<b>Item no.: 850-814/002-000</b> IP65 enclosure; Sheet steel (RAL 7035); WxHxD (200x120x200 mm); without flange plate	<a href="http://www.wago.com/850-814/002-000">www.wago.com/850-814/002-000</a>
	<b>Item no.: 850-815/002-000</b> IP65 enclosure; Sheet steel (RAL 7035); WxHxD (300x120x200 mm); without flange plate	<a href="http://www.wago.com/850-815/002-000">www.wago.com/850-815/002-000</a>
	<b>Item no.: 850-816/002-000</b> IP65 enclosure; Sheet steel (RAL 7035); WxHxD (400x120x200 mm); without flange plate	<a href="http://www.wago.com/850-816/002-000">www.wago.com/850-816/002-000</a>
	<b>Item no.: 850-817/002-000</b> IP65 enclosure; Sheet steel (RAL 7035); WxHxD (600x120x200 mm); without flange plate	<a href="http://www.wago.com/850-817/002-000">www.wago.com/850-817/002-000</a>
	<b>Item no.: 850-825</b> IP65 enclosure; Aluminium (RAL 7032); WxHxD (160x100x160 mm); 9 x M12, 4 x M20	<a href="http://www.wago.com/850-825">www.wago.com/850-825</a>
	<b>Item no.: 850-826</b>	

Subject to changes. Please also observe the further product documentation!

	IP65 enclosure; Aluminium (RAL 7032); WxHxD (240x100x160 mm); 4 x M20, 4 x M16, 14 x M12 cable grip	<a href="http://www.wago.com/850-826">www.wago.com/850-826</a>
	<b>Item no.: 850-826/002-000</b> IP65 enclosure; Aluminium (RAL 7035); WxHxD (240x100x160 mm); 4 x M20, 4 x M16, 14 x M12 cable grip	<a href="http://www.wago.com/850-826/002-000">www.wago.com/850-826/002-000</a>
	<b>Item no.: 850-827</b> IP65 enclosure; Aluminium (RAL 7032); WxHxD (320x100x160 mm); 4 x M20, 8 x M16, 17 x M12 cable grip	<a href="http://www.wago.com/850-827">www.wago.com/850-827</a>
	<b>Item no.: 850-827/002-000</b> IP65 enclosure; Aluminium (RAL 7035); WxHxD (320x100x160 mm); 4 x M20, 8 x M16, 17 x M12 cable grip	<a href="http://www.wago.com/850-827/002-000">www.wago.com/850-827/002-000</a>
	<b>Item no.: 850-828</b> IP65 enclosure; Aluminium (RAL 7032); WxHxD (480x100x160 mm); 4 x M20, 10 x M16, 35 x M12 cable grip	<a href="http://www.wago.com/850-828">www.wago.com/850-828</a>
	<b>Item no.: 850-828/002-000</b> IP65 enclosure; Aluminium (RAL 7035); WxHxD (480x100x160 mm); 4 x M20, 10 x M16, 35 x M12 cable grip	<a href="http://www.wago.com/850-828/002-000">www.wago.com/850-828/002-000</a>
	<b>Item no.: 850-834</b> IP65 enclosure; Polyester (RAL 7032); WxHxD (164x100x164 mm); 9 x M12, 4 x M20	<a href="http://www.wago.com/850-834">www.wago.com/850-834</a>
	<b>Item no.: 850-835</b> IP65 enclosure; Polyester (RAL 7032); WxHxD (244x100x164 mm); 4 x M20, 4 x M16, 14 x M12 cable grip	<a href="http://www.wago.com/850-835">www.wago.com/850-835</a>
	<b>Item no.: 850-836</b> IP65 enclosure; Polyester (RAL 7032); WxHxD (324x100x164 mm); 4 x M20, 8 x M16, 17 x M12 cable grip	<a href="http://www.wago.com/850-836">www.wago.com/850-836</a>
<b>Carrier rail</b>		
	<b>Item no.: 210-112</b> Steel carrier rail; 35 x 7.5 mm; 1 mm thick; 2 m long; slotted; according to EN 60715; "Hole width 25 mm	<a href="http://www.wago.com/210-112">www.wago.com/210-112</a>
	<b>Item no.: 210-113</b> Steel carrier rail; 35 x 7.5 mm; 1 mm thick; 2 m long; unslotted; according to EN 60715	<a href="http://www.wago.com/210-113">www.wago.com/210-113</a>
	<b>Item no.: 210-114</b> Steel carrier rail; 35 x 15 mm; 1.5 mm thick; 2 m long; unslotted; similar to EN 60715	<a href="http://www.wago.com/210-114">www.wago.com/210-114</a>
	<b>Item no.: 210-115</b> Steel carrier rail; 35 x 7.5 mm; 1 mm thick; 2 m long; slotted; according to EN 60715; "Hole width 18 mm	<a href="http://www.wago.com/210-115">www.wago.com/210-115</a>
	<b>Item no.: 210-118</b> Steel carrier rail; 35 x 15 mm; 2.3 mm thick; 2 m long; unslotted; according to EN 60715	<a href="http://www.wago.com/210-118">www.wago.com/210-118</a>
	<b>Item no.: 210-196</b> Aluminum carrier rail; 35 x 8.2 mm; 1.6 mm thick; 2 m long; unslotted; similar to EN 60715; silver-colored	<a href="http://www.wago.com/210-196">www.wago.com/210-196</a>
	<b>Item no.: 210-197</b> Steel carrier rail; 35 x 15 mm; 1.5 mm thick; 2 m long; slotted; similar to EN 60715	<a href="http://www.wago.com/210-197">www.wago.com/210-197</a>

Subject to changes. Please also observe the further product documentation!



**Item no.: 210-198**

Copper carrier rail; 35 x 15 mm; 2.3 mm thick; 2 m long; unslotted; according to EN 60715; copper-colored

[www.wago.com/210-198](http://www.wago.com/210-198)

**Item no.: 210-504**

Steel carrier rail; 35 x 7.5 mm; 1 mm thick; 2 m long; slotted; galvanized; according to EN 60715

[www.wago.com/210-504](http://www.wago.com/210-504)

**Item no.: 210-505**

Steel carrier rail; 35 x 7.5 mm; 1 mm thick; 2 m long; unslotted; galvanized; according to EN 60715

[www.wago.com/210-505](http://www.wago.com/210-505)

**Item no.: 210-506**

Steel carrier rail; 35 x 15 mm; 1.5 mm thick; 2 m long; unslotted; galvanized; similar to EN 60715

[www.wago.com/210-506](http://www.wago.com/210-506)

**Item no.: 210-508**

Steel carrier rail; 35 x 15 mm; 1.5 mm thick; 2 m long; slotted; galvanized; similar to EN 60715

[www.wago.com/210-508](http://www.wago.com/210-508)

**Marking accessories**

**Item no.: 2009-145**

Mini-WSB Inline; for Smart Printer; 1700 pieces on roll; stretchable 5 - 5.2 mm; plain; snap-on type; white

[www.wago.com/2009-145](http://www.wago.com/2009-145)

**Item no.: 2009-145/000-002**

Mini-WSB Inline; for Smart Printer; 1700 pieces on roll; stretchable 5 - 5.2 mm; plain; snap-on type; white /000-002

[www.wago.com/2009-145](http://www.wago.com/2009-145)

**Item no.: 2009-145/000-005**

Mini-WSB Inline; for Smart Printer; 1700 pieces on roll; stretchable 5 - 5.2 mm; plain; snap-on type; red

[www.wago.com/2009-145](http://www.wago.com/2009-145)

**Item no.: 2009-145/000-006**

Mini-WSB Inline; for Smart Printer; 1700 pieces on roll; stretchable 5 - 5.2 mm; plain; snap-on type; blue

[www.wago.com/2009-145](http://www.wago.com/2009-145)

**Item no.: 2009-145/000-007**

Mini-WSB Inline; for Smart Printer; 1700 pieces on roll; stretchable 5 - 5.2 mm; plain; snap-on type; white /000-007

[www.wago.com/2009-145](http://www.wago.com/2009-145)

**Item no.: 2009-145/000-012**

Mini-WSB Inline; for Smart Printer; 1700 pieces on roll; stretchable 5 - 5.2 mm; plain; snap-on type; orange

[www.wago.com/2009-145](http://www.wago.com/2009-145)  
/000-012

**Item no.: 2009-145/000-023**

Mini-WSB Inline; for Smart Printer; 1700 pieces on roll; stretchable 5 - 5.2 mm; plain; snap-on type; green

[www.wago.com/2009-145](http://www.wago.com/2009-145)  
/000-023

**Item no.: 2009-145/000-024**

Mini-WSB Inline; for Smart Printer; 1700 pieces on roll; stretchable 5 - 5.2 mm; plain; snap-on type; violet

[www.wago.com/2009-145](http://www.wago.com/2009-145)  
/000-024



**Item no.: 248-501**

Miniature WSB Quick marking system; plain; Marker width 5 mm; 10 strips with 10 markers per card

[www.wago.com/248-501](http://www.wago.com/248-501)

**Item no.: 248-501/000-002**

Mini-WSB marking card; as card; not stretchable; plain; snap-on type; yellow

[www.wago.com/248-501](http://www.wago.com/248-501)  
/000-002

Subject to changes. Please also observe the further product documentation!

WAGO Kontakttechnik GmbH & Co. KG

Hansastr. 27

32423 Minden

Phone: +49571 887-0 | Fax: +49571 887-169

Email: [info.de@wago.com](mailto:info.de@wago.com) | Web: [www.wago.com](http://www.wago.com)

Do you have any questions about our products?

We are always happy to take your call at +49 (571) 887-44222.





**Item no.: 248-501/000-005**  
Mini-WSB marking card; as card; not stretchable; plain; snap-on type; red

[www.wago.com/248-501/000-005](http://www.wago.com/248-501/000-005)

**Item no.: 248-501/000-006**  
Mini-WSB marking card; as card; not stretchable; plain; snap-on type; blue

[www.wago.com/248-501/000-006](http://www.wago.com/248-501/000-006)



**Item no.: 248-501/000-007**  
Mini-WSB marking card; as card; not stretchable; plain; snap-on type; gray

[www.wago.com/248-501/000-007](http://www.wago.com/248-501/000-007)

**Item no.: 248-501/000-012**  
Mini-WSB marking card; as card; not stretchable; plain; snap-on type; orange

[www.wago.com/248-501/000-012](http://www.wago.com/248-501/000-012)



**Item no.: 248-501/000-017**  
Mini-WSB marking card; as card; not stretchable; plain; snap-on type; light green

[www.wago.com/248-501/000-017](http://www.wago.com/248-501/000-017)

**Item no.: 248-501/000-023**  
Mini-WSB marking card; as card; not stretchable; plain; snap-on type; green

[www.wago.com/248-501/000-023](http://www.wago.com/248-501/000-023)

**Item no.: 248-501/000-024**  
Mini-WSB marking card; as card; not stretchable; plain; snap-on type; violet

[www.wago.com/248-501/000-024](http://www.wago.com/248-501/000-024)



**Item no.: 750-100**  
Marker card; as a DIN A4 sheet; plain; white

[www.wago.com/750-100](http://www.wago.com/750-100)



**Item no.: 750-103**  
Group marker carrier; transparent

[www.wago.com/750-103](http://www.wago.com/750-103)



**Item no.: 750-106**  
Group marker carrier; transparent

[www.wago.com/750-106](http://www.wago.com/750-106)

#### shield connection

**Item no.: 790-108**  
Shield clamping saddle; 11 mm wide; diameter of compatible conductor; 3 ... 8 mm

[www.wago.com/790-108](http://www.wago.com/790-108)

**Item no.: 790-116**  
Shield clamping saddle; 19 mm wide; diameter of compatible conductor; 7 ... 16 mm

[www.wago.com/790-116](http://www.wago.com/790-116)

**Item no.: 790-124**  
Shield clamping saddle; 27 mm wide; diameter of compatible conductor; 6 ... 24 mm

[www.wago.com/790-124](http://www.wago.com/790-124)

**Item no.: 790-140**  
Shield clamping saddle; diameter of compatible conductor

[www.wago.com/790-140](http://www.wago.com/790-140)



**Item no.: 790-208**  
Shield clamping saddle; 12.4 mm wide; 3 ... 8 mm

[www.wago.com/790-208](http://www.wago.com/790-208)

Subject to changes. Please also observe the further product documentation!



**Item no.: 790-216**

Shield clamping saddle; 21.8 mm wide; 6 ... 16 mm

[www.wago.com/790-216](http://www.wago.com/790-216)



**Item no.: 790-220**

Shield clamping saddle; 30 mm wide; 6 ... 20 mm

[www.wago.com/790-220](http://www.wago.com/790-220)

## Downloads

### Documentation

#### Manual

4-channel, 0-10VDC, single-ended	V 1.3.0	pdf 2.0 MB	Download
----------------------------------	---------	---------------	----------

#### Additional Information

Disposal; Electrical and electronic equipment, Packaging	V 1.0.0	pdf 265.8 kB	Download
--	---------	-----------------	----------

#### System Description

Use in Hazardous Environments Term definition, marking and installation regulations	V 1.0.0	pdf 1.0 MB	Download
--	---------	---------------	----------

750/753 Series I/O-System – General Product Information		pdf 1.7 MB	Download
---	--	---------------	----------

Design Notes Basic conditions and recommendations for higher operational safety	V 2.0.0	pdf 1.5 MB	Download
--	---------	---------------	----------

Overview on WAGO-I/O-SYSTEM 750 approvals		pdf 780.2 kB	Download
---	--	-----------------	----------

### CAD/CAE-Data

#### CAD data

2D/3D Models 750-468		URL	Download
----------------------	--	-----	----------

#### CAE data

EPLAN Data Portal 750-468		URL	Download
---------------------------	--	-----	----------

WSCAD Universe 750-468		URL	Download
------------------------	--	-----	----------

Subject to changes. Please also observe the further product documentation!



## Device Files

### Device Driver

---

WAGO USB Service Kabel Treiber / Serie 750 und 857	6.5.3.0 Sep 10, 2014	zip 4.8 MB	Download
--	-------------------------	---------------	----------

---

## Installation Notes

## Product family

**750/753 Series – I/O System**

[Show all products from the family](#)

Subject to changes. Please also observe the further product documentation!

---

WAGO Kontakttechnik GmbH & Co. KG  
Hansastr. 27  
32423 Minden  
Phone: +49571 887-0 | Fax: +49571 887-169  
Email: [info.de@wago.com](mailto:info.de@wago.com) | Web: [www.wago.com](http://www.wago.com)

Do you have any questions about our products?  
We are always happy to take your call at +49 (571) 887-44222.