

Data sheet | Item number: 733-105

1-conductor female plug; 100% protected against mismatching; 0.5 mm²; Pin spacing 2.5 mm; 5-pole; 0,50 mm²; light gray

www.wago.com/733-105

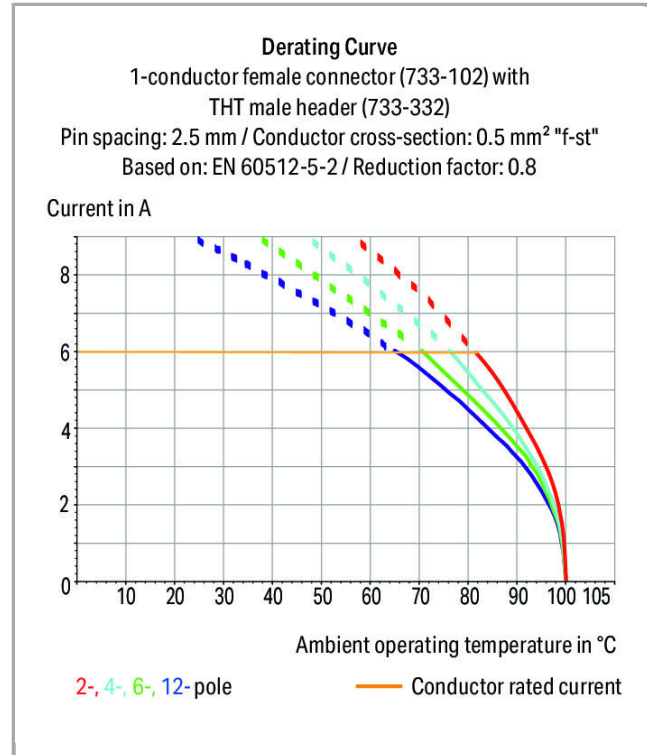

Subject to changes. Please also observe the further product documentation!

WAGO Kontakttechnik GmbH & Co. KG
Hansastr. 27
32423 Minden
Phone: +49571 887-0 | Fax: +49571 887-169
Email: info.de@wago.com | Web: www.wago.com

Do you have any questions about our products?
We are always happy to take your call at +49 (571) 887-44222.

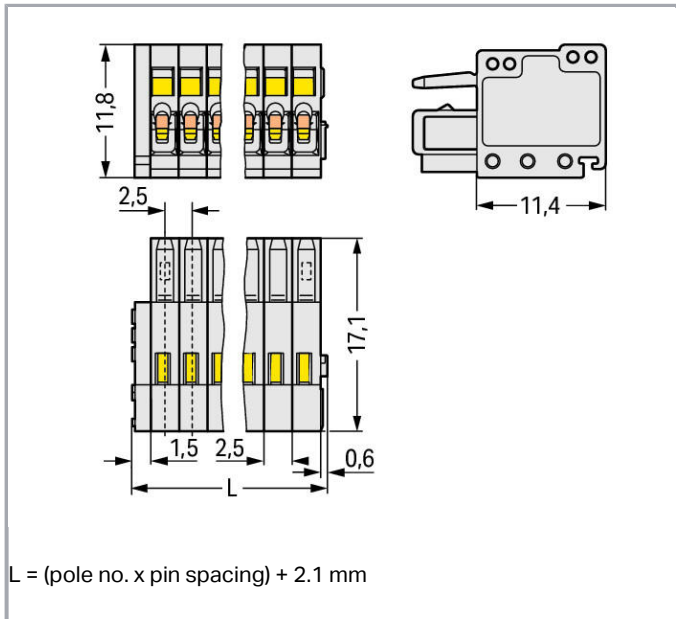

Item description

- Universal connection for all conductor types
- Easy cable pre-assembly and on-unit wiring via vertical and horizontal CAGE CLAMP® actuation
- Strain relief plates for factory and in-the-field assembly
- 100% protected against mismatching
- Coding via coding fingers

Safety information 1:

The MCS – MULTI CONNECTION SYSTEM includes connectors without breaking capacity in accordance with DIN EN 61984. When used as intended, these connectors must not be connected/disconnected when live or under load. The circuit design should ensure header pins, which can be touched, are not live when unmated.

Data

Electrical data

Ratings per IEC/EN 60664-1

Ratings per	IEC/EN 60664-1
Rated voltage (III / 3)	100 V
Rated impulse voltage (III / 3)	2.5 kV
Rated voltage (III / 2)	160 V
Rated impulse voltage (III / 2)	2.5 kV
Rated voltage (II / 2)	320 V

Subject to changes. Please also observe the further product documentation!

WAGO Kontakttechnik GmbH & Co. KG
 Hansastr. 27
 32423 Minden
 Phone: +49571 887-0 | Fax: +49571 887-169
 Email: info.de@wago.com | Web: www.wago.com

Do you have any questions about our products?
 We are always happy to take your call at +49 (571) 887-44222.



Rated impulse voltage (II / 2)	2.5 kV
Rated current	6 A
Legend (ratings)	(III / 2) \triangleq Overvoltage category III / Pollution degree 2

Approvals per UL 1059

Rated voltage UL (Use Group B)	150 V
Rated current UL (Use Group B)	4 A
Approvals per	UL 1059

Approvals per CSA

Rated voltage CSA (Use Group B)	150 V
Rated current CSA (Use Group B)	4 A

Connection data

Connection technology	CAGE CLAMP®
Actuation type	Operating tool
Solid conductor	0,08 ... 0,5 mm ² / 28 ... 20 AWG
Fine-stranded conductor	0,08 ... 0,5 mm ² / 28 ... 20 AWG
Fine-stranded conductor with ferrule with plastic collar	0,25 ... 0,34 mm ²
Fine-stranded conductor with ferrule without plastic collar	0,25 ... 0,34 mm ²
Strip length	5 ... 6 mm / 0.2 ... 0.24 inch
No. of poles	5
Total number of connection points	5
Total number of potentials	5
Number of connection types	1
Number of levels	1
Conductor entry direction to mating direction	0°

Geometrical Data

Pin spacing	2,5 mm / 0.098 inch
Width	14,6 mm / 0.574 inch
Height	11,8 mm / 0.465 inch
Depth	17,1 mm / 0.673 inch

Plug connection

Contact type (pluggable connector)	Female connector/socket
------------------------------------	-------------------------

Subject to changes. Please also observe the further product documentation!

Connector connection type	for conductor
Mismating protection	Yes

Material Data

Color	light gray
Material group	I
Insulating material	Polyamide 66 (PA 66)
Flammability class per UL94	V0
Clamping spring material	Chrome nickel spring steel (CrNi)
Contact material	Copper alloy
Contact plating	tin-plated
Fire load	0.041 MJ
Weight	2.2 g

Environmental Requirements



Limit temperature range	-60 ... +100 °C
-------------------------	-----------------

Commercial data

Product Group	3 (Multi Conn. System)
Packaging type	BOX
Country of origin	DE
GTIN	4044918294034
Customs Tariff No.	85366990990



Approvals / Certificates

Country specific Approvals



Logo	Approval	Additional Approval Text	Certificate name
	CCA DEKRA Certification B.V.	EN 61984	2169534.01
	CCA DEKRA Certification B.V.	IEC 61984	NL-31141
	CSA DEKRA Certification B.V.	C22.2	1465035

Subject to changes. Please also observe the further product documentation!



Ship Approvals

Logo	Approval	Additional Approval Text	Certificate name
	ABS American Bureau of Shipping	-	19- HG1869876- PDA
	DNV GL Det Norske Veritas, Germanischer Lloyd	-	TAE000016Z
	LR Lloyds Register	IEC 61984	96/20035 (E5)

UL-Approvals

Logo	Approval	Additional Approval Text	Certificate name
	UL UL International Germany GmbH	UL 1977	E45171
	UR Underwriters Laboratories Inc.	UL 1059	20190122- E45172

Counterpart

	Item no.733-205 1-conductor male connector; 100% protected against mismatching; 0.5 mm ² ; Pin spacing 2.5 mm; 5-pole; 0,50 mm ² ; light gray	www.wago.com/733-205
	Item no.733-205/033-000 1-conductor male connector; 100% protected against mismatching; Strain relief plate; 0.5 mm ² ; Pin spacing 2.5 mm; 5-pole; 0,50 mm ² ; light gray	www.wago.com/733-205/033-000
	Item no.733-335 THT male header; 0.8 x 0.8 mm solder pin; straight; 100% protected against mismatching; Pin spacing 2.5 mm; 5-pole; light gray	www.wago.com/733-335

Subject to changes. Please also observe the further product documentation!



Item no.733-335/105-604/997-446

THR male header; 0.8 x 0.8 mm solder pin; straight; 100% protected against mismatching; in tape-and-reel packaging; Pin spacing 2.5 mm; 5-pole; black

www.wago.com/733-335/105-604/997-446



Item no.733-335/105-604

THR male header; 0.8 x 0.8 mm solder pin; straight; 100% protected against mismatching; Pin spacing 2.5 mm; 5-pole; black

www.wago.com/733-335/105-604



Item no.733-365

THT male header; 0.8 x 0.8 mm solder pin; angled; 100% protected against mismatching; Pin spacing 2.5 mm; 5-pole; light gray

www.wago.com/733-365



Item no.733-365/105-604

THR male header; 0.8 x 0.8 mm solder pin; angled; 100% protected against mismatching; Pin spacing 2.5 mm; 5-pole; black

www.wago.com/733-365/105-604



Item no.733-365/105-604/997-406

THR male header; 0.8 x 0.8 mm solder pin; angled; 100% protected against mismatching; in tape-and-reel packaging; Pin spacing 2.5 mm; 5-pole; black

www.wago.com/733-365/105-604/997-406

Compatible products

Strain relief plate



Item no.: 734-128

Strain relief plate; 12.5 mm wide; light gray

www.wago.com/734-128

ferrule

Item no.: 216-131

Ferrule; Sleeve for 0.25 mm² / AWG 24; uninsulated; electro-tin plated

www.wago.com/216-131



Item no.: 216-132

Ferrule; Sleeve for 0.34 mm² / AWG 24; uninsulated; electro-tin plated

www.wago.com/216-132

Item no.: 216-151

Ferrule; Sleeve for 0.25 mm² / AWG 24; uninsulated; electro-tin plated

www.wago.com/216-151

Item no.: 216-152

Ferrule; Sleeve for 0.34 mm² / AWG 24; uninsulated; electro-tin plated

www.wago.com/216-152

Item no.: 216-301

Ferrule; Sleeve for 0.25 mm² / AWG 24; insulated; electro-tin plated; yellow

www.wago.com/216-301



Item no.: 216-302

Ferrule; Sleeve for 0.34 mm² / 22 AWG; insulated; electro-tin plated; green

www.wago.com/216-302

Subject to changes. Please also observe the further product documentation!

WAGO Kontakttechnik GmbH & Co. KG

Hansastr. 27



32423 Minden

Phone: +49571 887-0 | Fax: +49571 887-169

Email: info.de@wago.com | Web: www.wago.com

Do you have any questions about our products?

We are always happy to take your call at +49 (571) 887-44222.

	Item no.: 216-321 Ferrule; Sleeve for 0.25 mm ² / AWG 24; insulated; electro-tin plated; yellow	www.wago.com/216-321
	Item no.: 216-322 Ferrule; Sleeve for 0.34 mm ² / 22 AWG; insulated; electro-tin plated; green	www.wago.com/216-322
tools		
	Item no.: 210-251 Operating tool; for MCS MICRO & MINI with CAGE CLAMP® connection; yellow	www.wago.com/210-251
	Item no.: 210-719 Operating tool; Blade: 2.5 x 0.4 mm; with a partially insulated shaft	www.wago.com/210-719
	Item no.: 233-331 Operating tool; insulated; yellow	www.wago.com/233-331
	Item no.: 233-332 Operating tool; made of insulating material	www.wago.com/233-332
	Item no.: 233-335 Operating tool	www.wago.com/233-335
	Item no.: 733-130 Operating tool; loose; natural	www.wago.com/733-130
	Item no.: 733-191 Operating tool; loose; yellow	www.wago.com/733-191
Test Accessories		
	Item no.: 735-500 Test pin; 1 mm Ø; with solder connection for test wire	www.wago.com/735-500
Marking accessories		
	Item no.: 210-331/250-202 Marking strips; as a DIN A4 sheet; MARKED; 1-16 (400x); Height of marker strip: 2.3 mm/0.091 in; Strip length 182 mm; Horizontal marking; Self-adhesive; white	www.wago.com/210-331/250-202
	Item no.: 210-331/250-204 Marking strips; as a DIN A4 sheet; MARKED; 17-32 (400x); Height of marker strip: 2.3 mm/0.091 in; Strip length 182 mm; Horizontal marking; Self-adhesive; white	www.wago.com/210-331/250-204
	Item no.: 210-331/250-206 Marking strips; as a DIN A4 sheet; MARKED; 33-48 (400x); Height of marker strip: 2.3 mm/0.091 in; Strip length 182 mm; Horizontal marking; Self-adhesive; white	www.wago.com/210-331/250-206
	Item no.: 210-331/250-207 Marking strips; as a DIN A4 sheet; MARKED; 1-48 (100x); Height of marker strip: 2.3 mm/0.091 in; Strip length 182 mm; Horizontal marking; Self-adhesive; white	www.wago.com/210-331/250-207

Subject to changes. Please also observe the further product documentation!

Downloads

Documentation

Additional Information

Technical explanations	Apr 3, 2019	pdf 3.6 MB	Download
------------------------	-------------	---------------	----------

CAD/CAE-Data

CAD data

2D/3D Models 733-105	URL	Download
----------------------	-----	----------

CAE data

EPLAN Data Portal 733-105	URL	Download
---------------------------	-----	----------

Installation Notes

Protected Against Mismatching

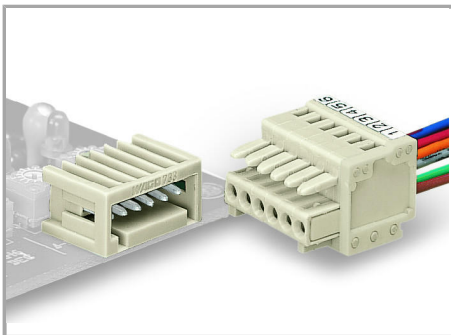

Male headers and female connectors are 100 % protected against mismatching.

Only mating halves with the same pole number can be connected.

Inserting a conductor

Subject to changes. Please also observe the further product documentation!

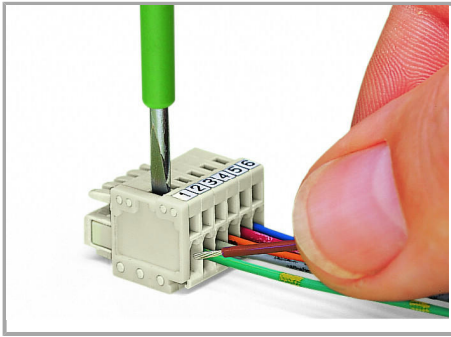

Inserting a conductor via (2.5 x 0.4) mm screwdriver. Operation is performed perpendicular to conductor entry.

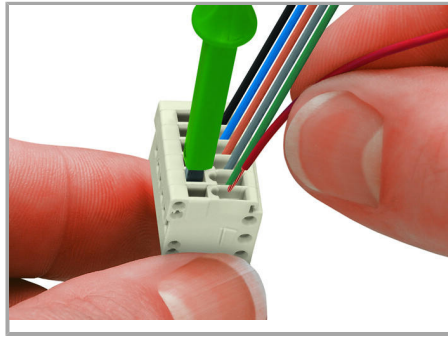

Inserting a conductor via screwdriver (233-335) – CAGE CLAMP® actuation parallel to conductor entry.

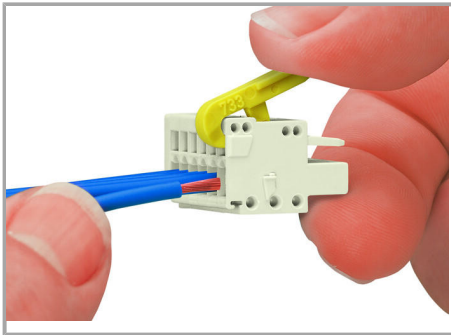
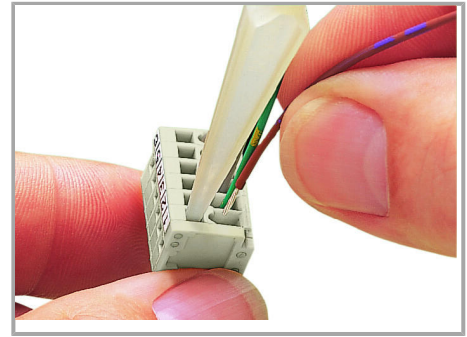

Inserting a conductor via 733-191 Operating Lever.

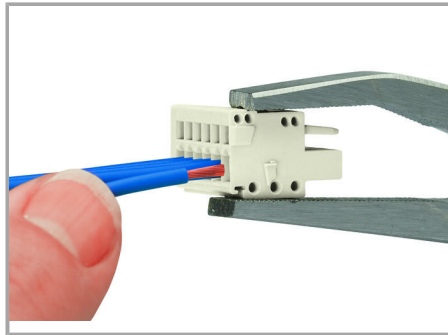

Inserting a conductor via 210-251 Operating Tool.

Coding

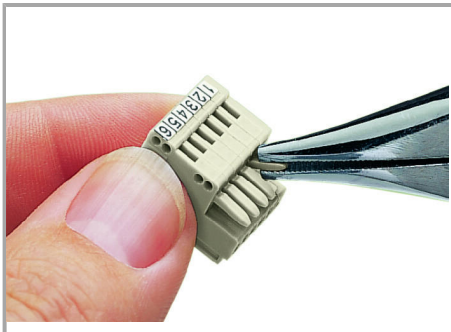

Coding a female connector – removing coding finger(s).

Subject to changes. Please also observe the further product documentation!

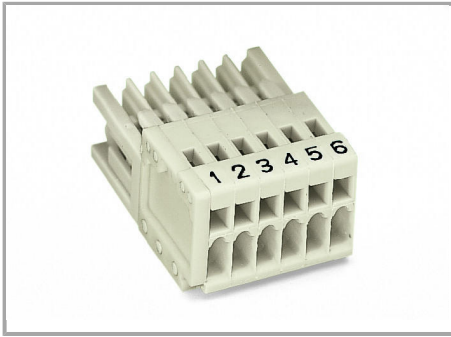

Assembly

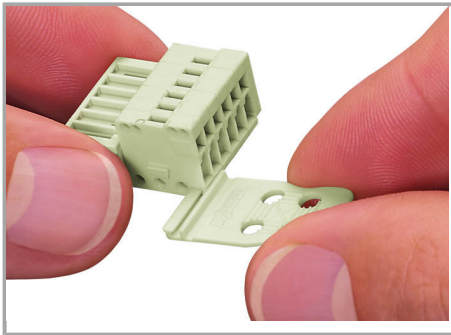

Strain relief plates for factory or in-the-field assembly.

Testing

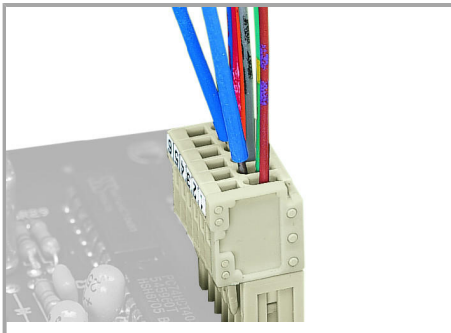

Testing via 1 mm Ø test pin (735-500) – touch contact.

Product family

<i>MCS</i> MICRO

[Learn more about the product family.](#)

[Show all products from the family](#)

Subject to changes. Please also observe the further product documentation!