

Data sheet | Item number: 733-102/037-000/032-000

1-conductor female plug; 100% protected against mismatching; Locking lever;
Strain relief plate; direct marking; 0.5 mm²; Pin spacing 2.5 mm; 2-pole; 0,50
mm²; light gray

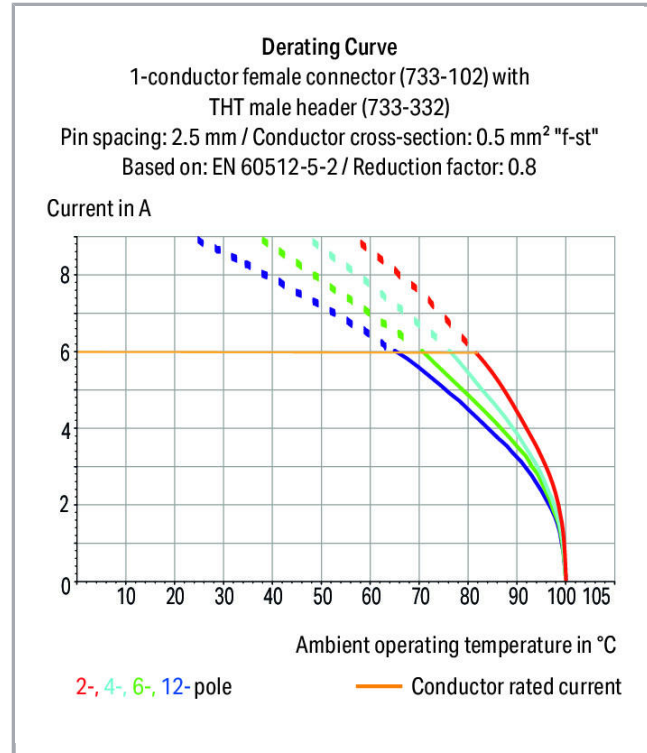

www.wago.com/733-102/037-000/032-000



Subject to changes. Please also observe the further product documentation!

WAGO Kontakttechnik GmbH & Co. KG
Hansastr. 27
32423 Minden
Phone: +49571 887-0 | Fax: +49571 887-169
Email: info.de@wago.com | Web: www.wago.com

Do you have any questions about our products?
We are always happy to take your call at +49 (571) 887-44222.

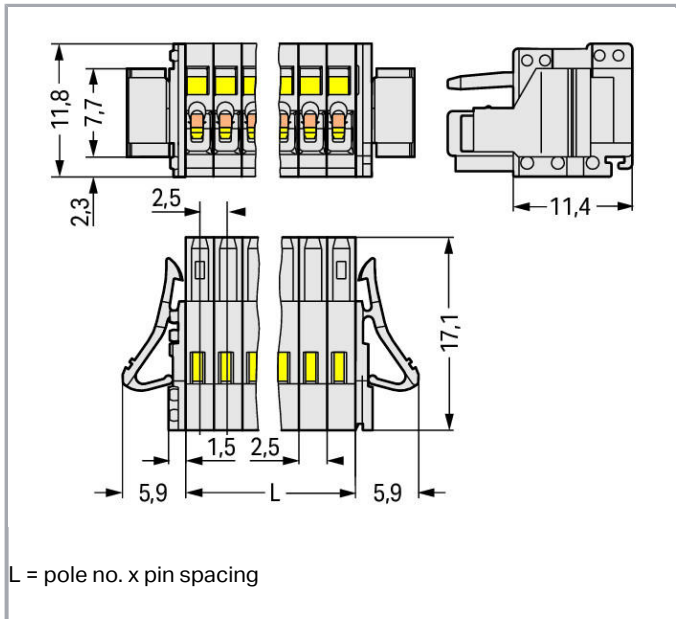

Item description

- Universal connection for all conductor types
- Easy cable pre-assembly and on-unit wiring via vertical and horizontal CAGE CLAMP® actuation
- Strain relief plates for factory and in-the-field assembly
- 100% protected against mismatching
- Coding via coding fingers

Safety information 1:

The *MULTI CONNECTION SYSTEM (MCS)* is designed without breaking capacity for compliance with DIN EN 61984. When used as intended, MCS Connectors shall not be connected/disconnected when live or under load. The circuit design should ensure header pins, which can be touched, are not live when unmated.

Data

Electrical data

Ratings per IEC/EN 60664-1

| Ratings per | IEC/EN 60664-1 |
|---------------------------------|----------------|
| Rated voltage (III / 3) | 100 V |
| Rated impulse voltage (III / 3) | 2.5 kV |
| Rated voltage (III / 2) | 160 V |
| Rated impulse voltage (III / 2) | 2.5 kV |
| Rated voltage (II / 2) | 320 V |

Subject to changes. Please also observe the further product documentation!

WAGO Kontakttechnik GmbH & Co. KG
 Hansastr. 27
 32423 Minden
 Phone: +49571 887-0 | Fax: +49571 887-169
 Email: info.de@wago.com | Web: www.wago.com

Do you have any questions about our products?
 We are always happy to take your call at +49 (571) 887-44222.



| | |
|--------------------------------|----------------------------------------------------------------------|
| Rated impulse voltage (II / 2) | 2.5 kV |
| Rated current | 6 A |
| Legend (ratings) | (III / 2) \triangleq Overvoltage category III / Pollution degree 2 |

Approvals per UL 1059

| | |
|--------------------------------|---------|
| Rated voltage UL (Use Group B) | 150 V |
| Rated current UL (Use Group B) | 4 A |
| Approvals per | UL 1059 |

Approvals per CSA

| | |
|---------------------------------|-------|
| Rated voltage CSA (Use Group B) | 150 V |
| Rated current CSA (Use Group B) | 4 A |

Connection data

| | |
|-------------------------------------------------------------|----------------------------------------------|
| Connection technology | CAGE CLAMP® |
| Actuation type | Operating tool |
| Solid conductor | 0.08 ... 0.5 mm ² / 28 ... 20 AWG |
| Fine-stranded conductor | 0.08 ... 0.5 mm ² / 28 ... 20 AWG |
| Fine-stranded conductor with ferrule with plastic collar | 0.25 ... 0.34 mm ² |
| Fine-stranded conductor with ferrule without plastic collar | 0.25 ... 0.34 mm ² |
| Strip length | 5 ... 6 mm / 0.2 ... 0.24 inch |
| No. of poles | 2 |
| Total number of connection points | 2 |
| Total number of potentials | 2 |
| Number of connection types | 1 |
| Number of levels | 1 |
| Conductor entry direction to mating direction | 0° |

Geometrical Data

| | |
|-------------|----------------------|
| Pin spacing | 2.5 mm / 0.098 inch |
| Width | 16.8 mm / 0.661 inch |
| Height | 11.8 mm / 0.465 inch |
| Depth | 17.1 mm / 0.673 inch |

Plug connection

| | |
|------------------------------------|-------------------------|
| Contact type (pluggable connector) | Female connector/socket |
|------------------------------------|-------------------------|

Subject to changes. Please also observe the further product documentation!

WAGO Kontakttechnik GmbH & Co. KG
 Hansastr. 27
 32423 Minden
 Phone: +49571 887-0 | Fax: +49571 887-169
 Email: info.de@wago.com | Web: www.wago.com

Do you have any questions about our products?
 We are always happy to take your call at +49 (571) 887-44222.

| | |
|-------------------------------|----------------|
| Connector connection type | for conductors |
| Mismating protection | Yes |
| Locking of plug-in connection | locking lever |

Material Data

| | |
|-----------------------------|-----------------------------------|
| Color | light gray |
| Material group | I |
| Insulating material | Polyamide 66 (PA 66) |
| Flammability class per UL94 | V0 |
| Clamping spring material | Chrome nickel spring steel (CrNi) |
| Contact material | Copper alloy |
| Contact plating | tin-plated |
| Fire load | 0.035 MJ |
| Weight | 1.5 g |

Environmental Requirements

| | |
|-------------------------|-----------------|
| Limit temperature range | -60 ... +100 °C |
|-------------------------|-----------------|

Commercial data

| | |
|--------------------|------------------------|
| Product Group | 3 (Multi Conn. System) |
| Packaging type | BOX |
| Country of origin | DE |
| GTIN | 4050821111924 |
| Customs Tariff No. | 85366990990 |

Counterpart



Item no. 733-202

1-conductor male connector; 100% protected against mismating; 0.5 mm²; Pin spacing 2.5 mm; 2-pole; 0,50 mm²; light gray

www.wago.com/733-202



Item no. 733-362

THT male header; 0.8 x 0.8 mm solder pin; angled; 100% protected against mismating; Pin spacing 2.5 mm; 2-pole; light gray

www.wago.com/733-362



Item no. 733-332

THT male header; 0.8 x 0.8 mm solder pin; straight; 100% protected against mismating; Pin spacing 2.5 mm; 2-pole; light gray

www.wago.com/733-332

Subject to changes. Please also observe the further product documentation!

WAGO Kontakttechnik GmbH & Co. KG

Hansastr. 27

32423 Minden

Phone: +49571 887-0 | Fax: +49571 887-169



Email: info.de@wago.com | Web: www.wago.com

Do you have any questions about our products?

We are always happy to take your call at +49 (571) 887-44222.

Compatible products

ferrule

| | | |
|-----------------------------------------------------------------------------------|----------------------------------------------------------------------------------------------------------------------|----------------------------------------------------------------|
| | Item no.: 216-131 Ferrule; Sleeve for 0.25 mm ² / AWG 24; uninsulated; electro-tin plated | www.wago.com/216-131 |
|  | Item no.: 216-132 Ferrule; Sleeve for 0.34 mm ² / AWG 24; uninsulated; electro-tin plated | www.wago.com/216-132 |
| | Item no.: 216-151 Ferrule; Sleeve for 0.25 mm ² / AWG 24; uninsulated; electro-tin plated | www.wago.com/216-151 |
| | Item no.: 216-152 Ferrule; Sleeve for 0.34 mm ² / AWG 24; uninsulated; electro-tin plated | www.wago.com/216-152 |
| | Item no.: 216-301 Ferrule; Sleeve for 0.25 mm ² / AWG 24; insulated; electro-tin plated; yellow | www.wago.com/216-301 |
|  | Item no.: 216-302 Ferrule; Sleeve for 0.34 mm ² / 22 AWG; insulated; electro-tin plated; green | www.wago.com/216-302 |
| | Item no.: 216-321 Ferrule; Sleeve for 0.25 mm ² / AWG 24; insulated; electro-tin plated; yellow | www.wago.com/216-321 |
|  | Item no.: 216-322 Ferrule; Sleeve for 0.34 mm ² / 22 AWG; insulated; electro-tin plated; green | www.wago.com/216-322 |

Test Accessories

| | | |
|--|------------------------------------------------------------------------------------|----------------------------------------------------------------|
| | Item no.: 735-500 Test pin; 1 mm Ø; with solder connection for test wire | www.wago.com/735-500 |
|--|------------------------------------------------------------------------------------|----------------------------------------------------------------|

Marking accessories

| | | |
|--|-----------------------------------------------------------------------------------------------------------------------------------------------------------------------------------------------------|--------------------------------------------------------------------------------|
| | Item no.: 210-331/250-202 Marking strips; as a DIN A4 sheet; MARKED; 1-16 (400x); Height of marker strip: 2.3 mm/0.091 in; Strip length 182 mm; Horizontal marking; Self-adhesive; white | www.wago.com/210-331/250-202 |
| | Item no.: 210-331/250-204 Marking strips; as a DIN A4 sheet; MARKED; 17-32 (400x); Height of marker strip: 2.3 mm/0.091 in; Strip length 182 mm; Horizontal marking; Self-adhesive; white | www.wago.com/210-331/250-204 |
| | Item no.: 210-331/250-206 Marking strips; as a DIN A4 sheet; MARKED; 33-48 (400x); Height of marker strip: 2.3 mm/0.091 in; Strip length 182 mm; Horizontal marking; Self-adhesive; white | www.wago.com/210-331/250-206 |
| | Item no.: 210-331/250-207 Marking strips; as a DIN A4 sheet; MARKED; 1-48 (100x); Height of marker strip: 2.3 mm/0.091 in; Strip length 182 mm; Horizontal marking; Self-adhesive; white | www.wago.com/210-331/250-207 |

Subject to changes. Please also observe the further product documentation!

Strain relief plate

Item no.: 734-127

Strain relief plate; light gray

www.wago.com/734-127

tools

Item no.: 210-251

Operating tool; for MCS MICRO & MINI with CAGE CLAMP® connection; yellow

www.wago.com/210-251

Item no.: 210-719

Operating tool; Blade: 2.5 x 0.4 mm; with a partially insulated shaft

www.wago.com/210-719

Item no.: 233-331

Operating tool; insulated; yellow

www.wago.com/233-331

Item no.: 233-332

Operating tool; made of insulating material

www.wago.com/233-332

Item no.: 233-335

Operating tool

www.wago.com/233-335

Item no.: 733-130

Operating tool; loose; natural

www.wago.com/733-130



Item no.: 733-191

Operating tool; loose; yellow

www.wago.com/733-191

Downloads

Documentation

Additional Information

Technical explanations

Apr 3, 2019

pdf
3.6 MB

[Download](#)

Installation Notes

Protected Against Mismatching

Subject to changes. Please also observe the further product documentation!

WAGO Kontakttechnik GmbH & Co. KG

Hansastr. 27

32423 Minden

Phone: +49571 887-0 | Fax: +49571 887-169

Email: info.de@wago.com | Web: www.wago.com

Do you have any questions about our products?

We are always happy to take your call at +49 (571) 887-44222.

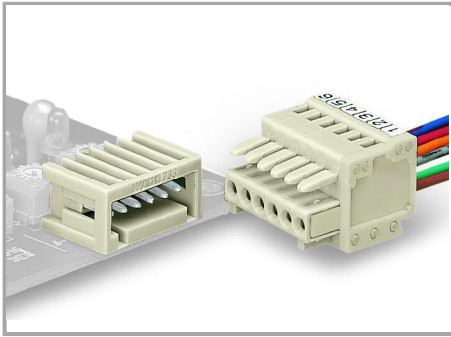

Male headers and female connectors are 100 % protected against mismatching.

Only mating halves with the same pole number can be connected.

Inserting a conductor

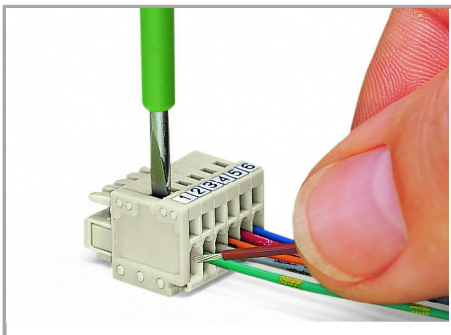

Inserting a conductor via (2.5 x 0.4) mm screwdriver. Operation is performed perpendicular to conductor entry.

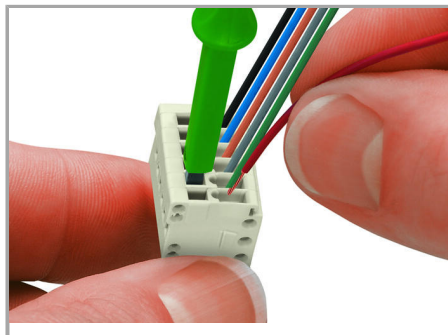

Inserting a conductor via screwdriver (233-335) – CAGE CLAMP® actuation parallel to conductor entry.

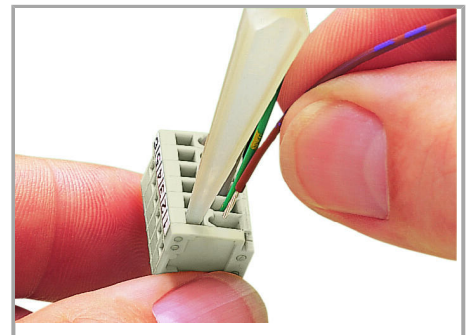

Subject to changes. Please also observe the further product documentation!

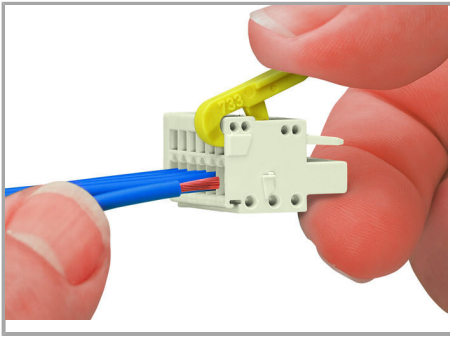

Inserting a conductor via 733-191 Operating Lever.

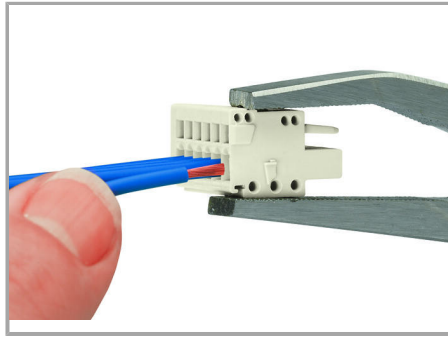

Inserting a conductor via 210-251 Operating Tool.

Coding

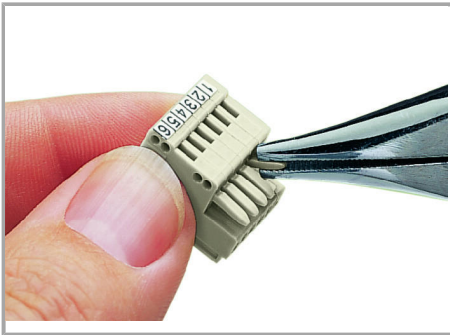

Coding a female connector – removing coding finger(s).

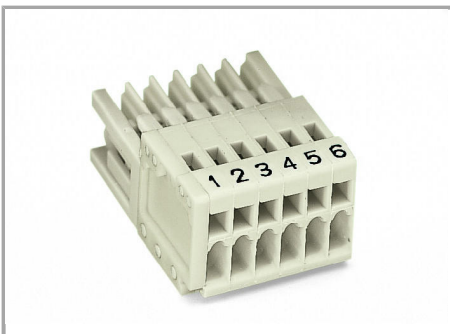

Assembly

Subject to changes. Please also observe the further product documentation!

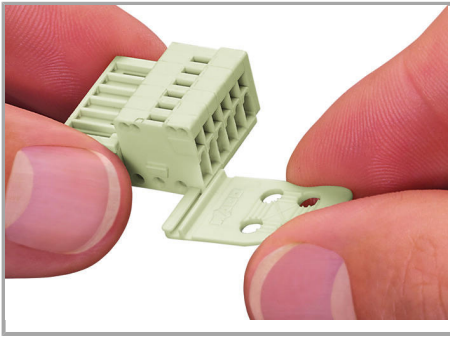

Strain relief plates for factory or in-the-field assembly.

Testing

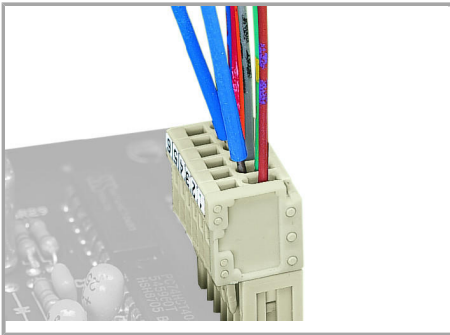

Testing via 1 mm Ø test pin (735-500) – touch contact.

Locking lever

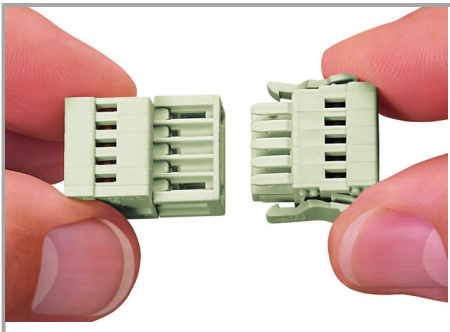

Locking levers prevent accidental disconnection.

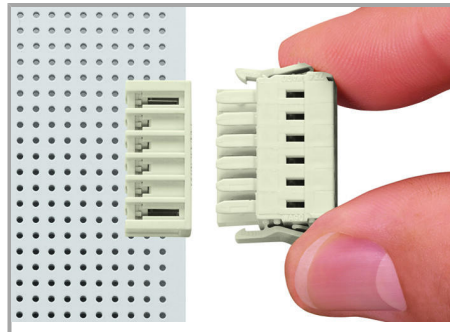

Locking levers prevent accidental disconnection.

Product family

Subject to changes. Please also observe the further product documentation!



<i>MCS</i> MICRO

[Learn more about the product family.](#)

[Show all products from the family](#)

Subject to changes. Please also observe the further product documentation!

WAGO Kontakttechnik GmbH & Co. KG
Hansastr. 27
32423 Minden
Phone: +49571 887-0 | Fax: +49571 887-169
Email: info.de@wago.com | Web: www.wago.com

Do you have any questions about our products?
We are always happy to take your call at +49 (571) 887-44222.