

Data sheet | Item number: 709-153

Cover; Type 1; suitable for cover carrier, type 1; 1 m long; transparent

www.wago.com/709-153

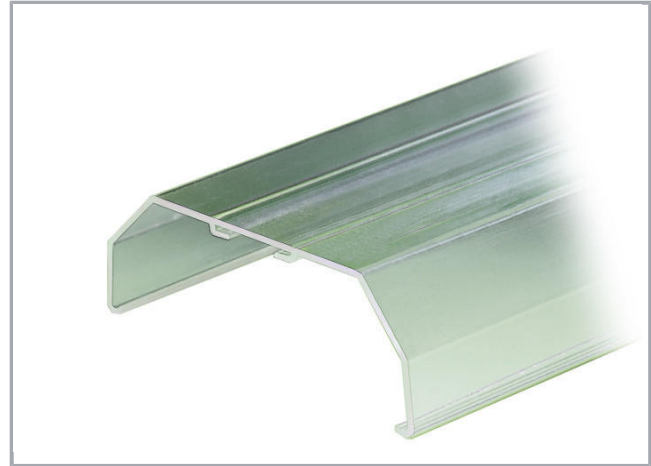

Subject to changes. Please also observe the further product documentation!

WAGO Kontakttechnik GmbH & Co. KG
Hansastr. 27
32423 Minden
Phone: +49571 887-0 | Fax: +49571 887-169
Email: info.de@wago.com | Web: www.wago.com

Do you have any questions about our products?
We are always happy to take your call at +49 (571) 887-44222.

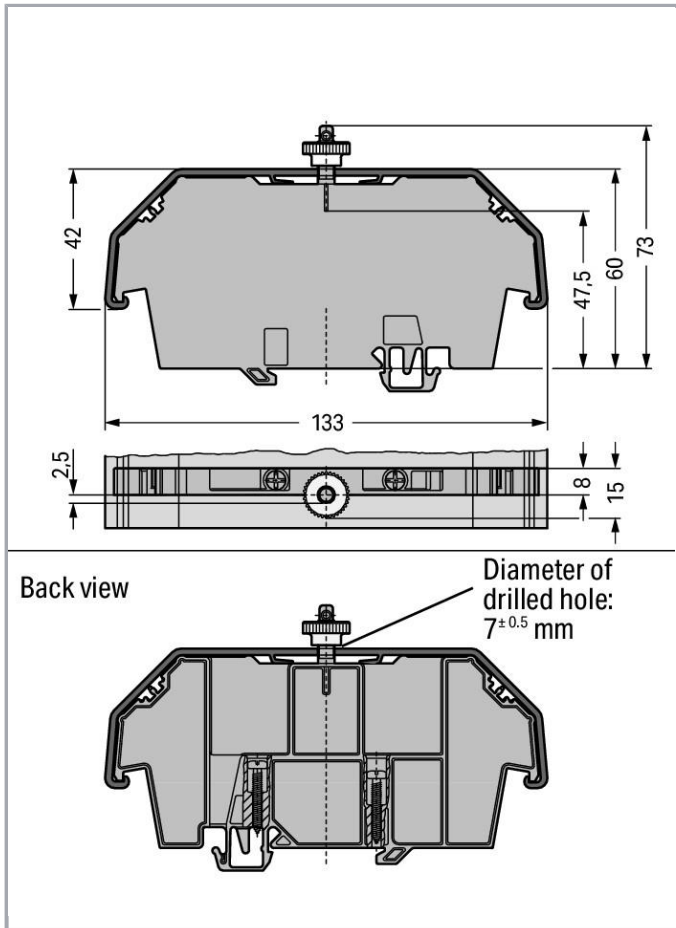

Data

Technical Data

Main product function

Mounting Accessories

Geometrical Data

Width	1000 mm / 39.37 inch
Height	42 mm / 1.654 inch
Depth	133 mm / 5.236 inch

Material Data

Color	transparent
Fire load	14.49 MJ
Weight	503 g

Subject to changes. Please also observe the further product documentation!

WAGO Kontakttechnik GmbH & Co. KG
 Hansastr. 27
 32423 Minden
 Phone: +49571 887-0 | Fax: +49571 887-169
 Email: info.de@wago.com | Web: www.wago.com

Do you have any questions about our products?
 We are always happy to take your call at +49 (571) 887-44222.

Commercial data

Product Group	2 (Terminal Block Accessories)
Packaging type	BOX
Country of origin	DE
GTIN	4017332361446
Customs Tariff No.	39169010900



Counterpart

Compatible products

Marking accessories

	Item no.: 709-183 Marking strips; for laser printer; white	www.wago.com/709-183
--	--	--

assembling

	Item no.: 209-196 Spare fixing/retaining screw; for cover	www.wago.com/209-196
	Item no.: 210-549 Spare knurled nut; for cover	www.wago.com/210-549
	Item no.: 709-167 Cover carrier; Type 1; incl. fixing/retaining screws and knurled nut; suitable for 279 to 282 and 880 Series rail-mounted terminal blocks; suitable for 264 Series miniature rail-mounted terminal blocks; suitable for 270 Series sensor and actuator terminal blocks; gray	www.wago.com/709-167

Downloads

CAD/CAE-Data

CAD data

2D/3D Models 709-153	URL	Download
----------------------	---------------------	--------------------------

CAE data

EPLAN Data Portal 709-153	URL	Download
---------------------------	---------------------	--------------------------

WSCAD Universe 709-153	URL	Download
------------------------	---------------------	--------------------------

Subject to changes. Please also observe the further product documentation!

Installation Notes

Marking

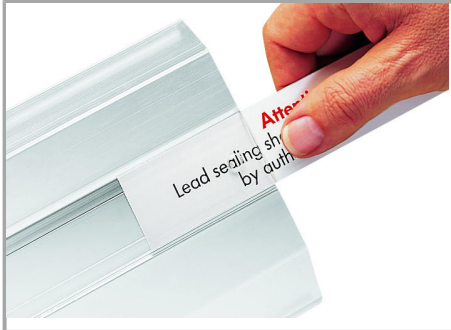

Inserting a marking strip into the cover.

Safety

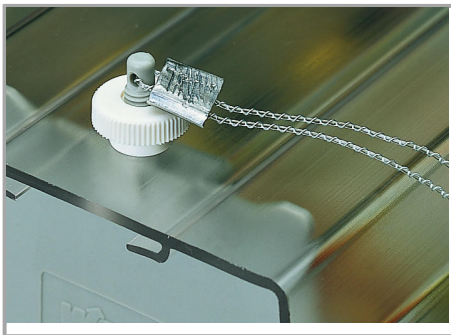

Cover with lead seals:

Using covers without lead seals, the thread dome-head can be broken off.

Subject to changes. Please also observe the further product documentation!