

## Data sheet | Item number: 294-5424

Lighting connector; push-button, external; with screw-type ground contact; 1 /L´-2/L-PE-N; 4-pole; Lighting side: for solid conductors; Inst. side: for all conductor types; max. 2.5 mm<sup>2</sup>; Surrounding air temperature: max 85°C (T85); 2,50 mm<sup>2</sup>; white

[www.wago.com/294-5424](http://www.wago.com/294-5424)

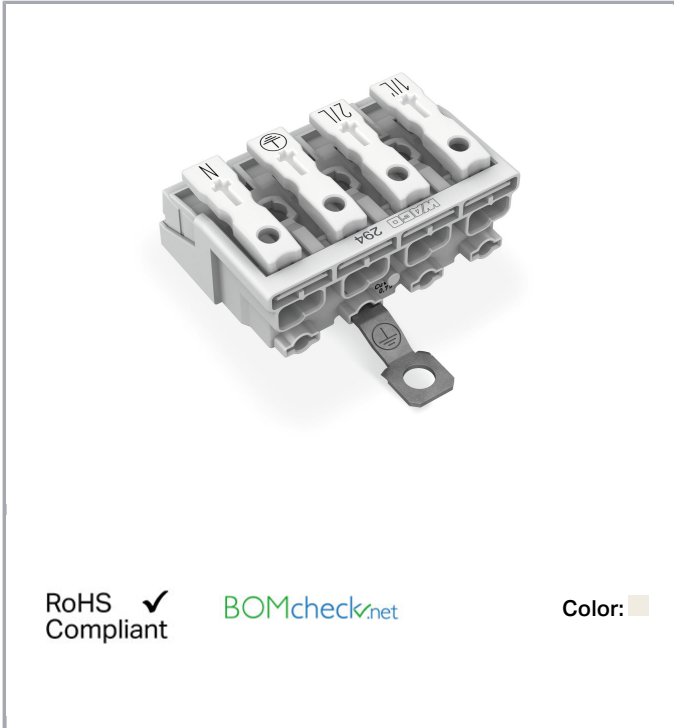

RoHS  Compliant

BOMcheck.net

Color:

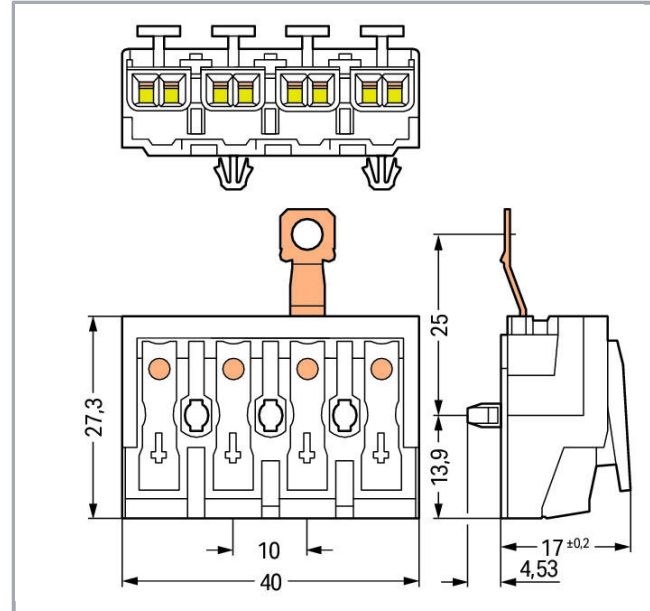

### Item description

- External connection of solid, stranded and fine-stranded conductors
- Universal conductor termination (AWG, metric)
- Third contact at bottom
- Strain relief plate can be retrofitted

### Data

#### Electrical data

#### Ratings per IEC/EN 60664-1

Ratings per	IEC/EN 60998-1
Ratings note	Connection points
Rated voltage (II / 2)	500 V

Subject to changes. Please also observe the further product documentation!

WAGO Kontakttechnik GmbH & Co. KG  
Hansastr. 27  
32423 Minden  
Phone: +49571 887-0 | Fax: +49571 887-169  
Email: [info.de@wago.com](mailto:info.de@wago.com) | Web: [www.wago.com](http://www.wago.com)

Do you have any questions about our products?  
We are always happy to take your call at +49 (571) 887-44222.



Rated impulse voltage (II / 2)	4 kV
Rated current	24 A
Ratings according to 2	IEC/EN 60998-2-2
Ratings note 2	Connection points
Rated voltage (II / 2) 2	500 V
Rated impulse voltage (II / 2) 2	4 kV
Rated current (2)	24 A
Rated current (3)	16 A
Legend (ratings)	(II / 2) $\triangleq$ Overvoltage category II / Pollution degree 2

### Connection data

Connection type (1)	External 1
Connection technology	Push-in CAGE CLAMP <sup>®</sup>
Number of connection points (connection type)	2
Actuation type	Operating tool Push-button
Connectable conductor materials	Copper
Solid conductor	0,5 ... 2,5 mm <sup>2</sup> / 18 ... 12 AWG
Solid conductor, push-in termination	0,5 ... 2,5 mm <sup>2</sup> / 18 ... 12 AWG
Stranded conductor	0,5 ... 2,5 mm <sup>2</sup> / 18 ... 14 AWG
Fine-stranded conductor	0,5 ... 2,5 mm <sup>2</sup> / 18 ... 14 AWG
Fine-stranded conductor with ferrule with plastic collar	0,5 ... 1,5 mm <sup>2</sup> / 18 ... 16 AWG
Fine-stranded conductor with ferrule without plastic collar	0,5 ... 1,5 mm <sup>2</sup> / 18 ... 16 AWG
Fine-stranded conductor with ferrule, push-in termination, from	0,5 mm <sup>2</sup> / 18 AWG
Strip length	8 ... 9 mm / 0.31 ... 0.35 inch
No. of poles	4
Connection type (2)	Internal 2
Connection technology 2	PUSH WIRE <sup>®</sup>
Number of connection points	1
Solid conductor (2)	0,5 ... 2,5 mm <sup>2</sup> / 18 ... 14 AWG
Fine-stranded conductor with insulated ferrule (2)	0,5 ... 1 mm <sup>2</sup> / 18 ... 16 AWG
Fine-stranded conductor with uninsulated ferrule (2)	0,5 ... 1,5 mm <sup>2</sup> / 18 ... 14 AWG
Strip length (2)	8 ... 9 mm / 0.31 ... 0.35 inch
Connection type (3)	Internal 3
Number of connection points	1
Solid conductor (3)	0,5 ... 1,5 mm <sup>2</sup> / 18 ... 16 AWG
Fine-stranded conductor with insulated ferrule (3)	0,5 ... 0,75 mm <sup>2</sup> / 18 AWG 0,5 ... 0,75 mm <sup>2</sup> / 18 AWG

Subject to changes. Please also observe the further product documentation!



Fine-stranded conductor with uninsulated ferrule (3)	0,5 ... 1 mm <sup>2</sup> / 18 AWG
Connection type (4)	Internal 4
Number of connection points	1
Solid conductor (4)	0,5 ... 0,75 mm <sup>2</sup> / 18 AWG
Total number of connection points	20
Total number of potentials	4
Number of connection types	4
Type of wiring	Side-entry wiring
Ground function	with screw-type ground contact

### Geometrical Data

Pin spacing	10 mm / 0.394 inch
Width	40 mm / 1.575 inch
Height from the surface	17 mm / 0.669 inch
Depth	27,3 mm / 1.075 inch

### Mechanical data

Mounting type	Snap-in mounting foot
Marking	1/L´-2/L-PE-N

### Material Data

Color	white
Material group	III a
Insulating material	Polycarbonate (PC)
Flammability class per UL94	V0
Clamping spring material	Chrome nickel spring steel (CrNi)
Contact material	Electrolytic copper (E <sub>Cu</sub> )
Contact plating	tin-plated
Fire load	0.242 MJ
Weight	12.9 g

### Environmental Requirements

Temperature stability	120 °C
T-Kennzeichnung	T85

Subject to changes. Please also observe the further product documentation!

## Commercial data

Product Group	8 (Misc. Chassis Mount Blocks)
Packaging type	bag
Country of origin	PL
GTIN	4050821098607
Customs Tariff No.	85369010000

## Approvals / Certificates



### Country specific Approvals

Logo	Approval	Additional Approval Text	Certificate name
	ENEC 05 DEKRA Certification B.V.	EN 60998	2128791.01



## Counterpart

## Compatible products

### Strain relief plate

	<b>Item no.: 294-364</b> Strain relief plate; for 294 Series; for multicore cables; 3- to 5-pole; with secured clamp; white	<a href="http://www.wago.com/294-364">www.wago.com/294-364</a>
	<b>Item no.: 294-370</b> Strain relief; for 294 Series; with snap-in mounting feet; white	<a href="http://www.wago.com/294-370">www.wago.com/294-370</a>
	<b>Item no.: 294-375</b> Strain relief; for 294 Series; without snap-in mounting feet; white	<a href="http://www.wago.com/294-375">www.wago.com/294-375</a>
	<b>Item no.: 294-384</b> Strain relief plate; for 294 Series; for single strands; 3- to 5-pole; with secured clamp; white	<a href="http://www.wago.com/294-384">www.wago.com/294-384</a>

### tools

	<b>Item no.: 206-294</b> Disconnection tool	<a href="http://www.wago.com/206-294">www.wago.com/206-294</a>
	<b>Item no.: 294-199</b> Operating tool; for pressing the snap-in mounting feet into the mounting plate; For fitting ground contacts; for 294 Series	<a href="http://www.wago.com/294-199">www.wago.com/294-199</a>

Subject to changes. Please also observe the further product documentation!

**Downloads**

**Documentation**

**Additional Information**

Technical explanations

Apr 3, 2019

pdf  
2.1 MB

Download

**CAD/CAE-Data**

**CAD data**

2D/3D Models 294-5424

URL

Download

**CAE data**

WSCAD Universe 294-5424

URL

Download

**Installation Notes**

**Installation**

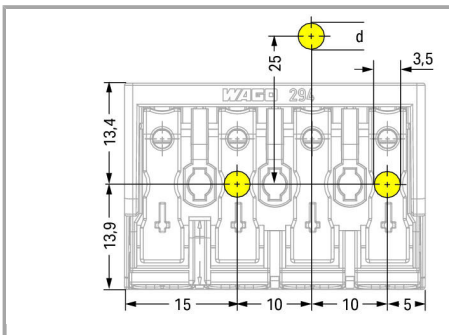

4-pole – with screw-type ground contact,  $d \leq 4.1$  mm

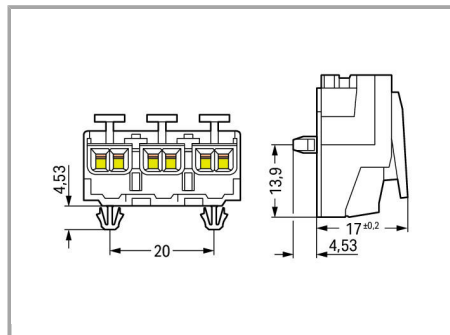

Snap-in mounting foot

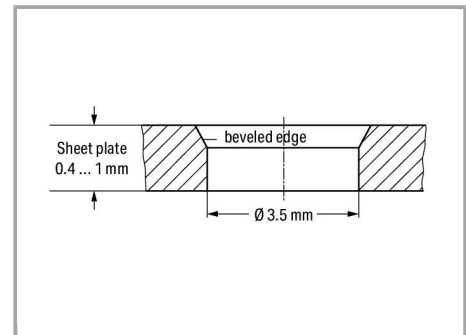

Drilled hole for snap-in mounting foot

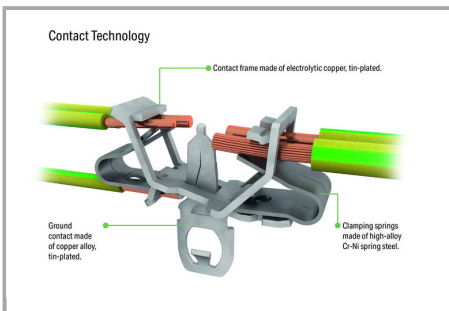

Subject to changes. Please also observe the further product documentation!

<b>EUROPE</b>
1 x 0.5 ... 2.5 mm <sup>2</sup> "s"
1 x 0.5 ... 1.5 mm <sup>2</sup> "s"
1 x 0.5 ... 0.75 mm <sup>2</sup> "s"
<b>AMERICA</b>
1 x AWG 18 ... 14 "s"
1 x AWG 18 ... 16 "s"
1 x AWG 18 "s"
<b>JAPAN</b>
1 x 0.8 ... 1.6 mm diam. "s"
1 x 0.8 ... 1 mm diam. "s"
1 x 0.8 mm diam. "s"

<b>EUROPE</b>
2 x 0.5 ... 2.5 mm <sup>2</sup> "s, str, f-str"
<b>AMERICA</b>
2 x AWG 18 ... 12 "s"
2 x AWG 18 ... 14 "s, f-str"
<b>JAPAN</b>
2 x 0.8 ... 2 mm diam. "s"
2 x 0.5 ... 2 mm <sup>2</sup> "str, f-str"

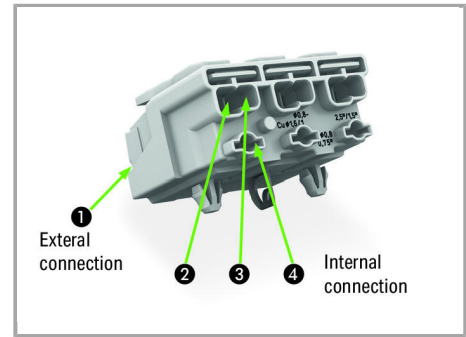

**Internal connection:**

**External connection:**

PUSH WIRE® for internal wiring with solid conductors

Push-in CAGE CLAMP® for field-wiring with all conductor types

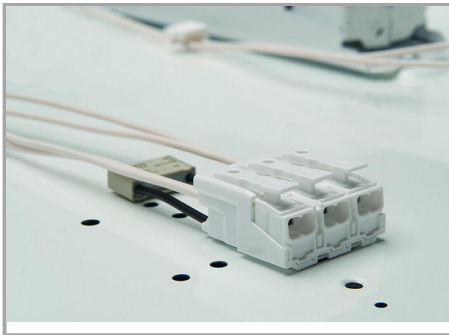

Terminating five conductors per pole – solid and fine-stranded.

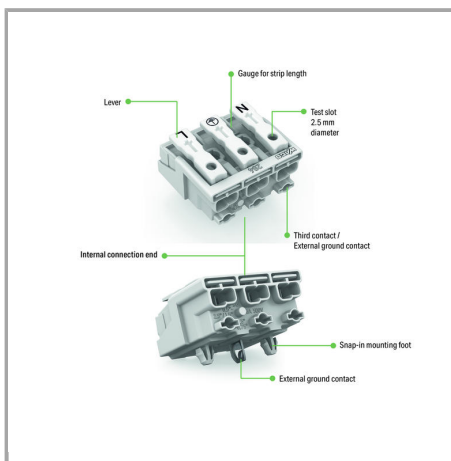

Subject to changes. Please also observe the further product documentation!