

Data sheet | Item number: 289-907

Constant voltage source; 27 ... 35 VDC input voltage; 24 VDC output voltage; 3 A output current; with mounting feet

www.wago.com/289-907

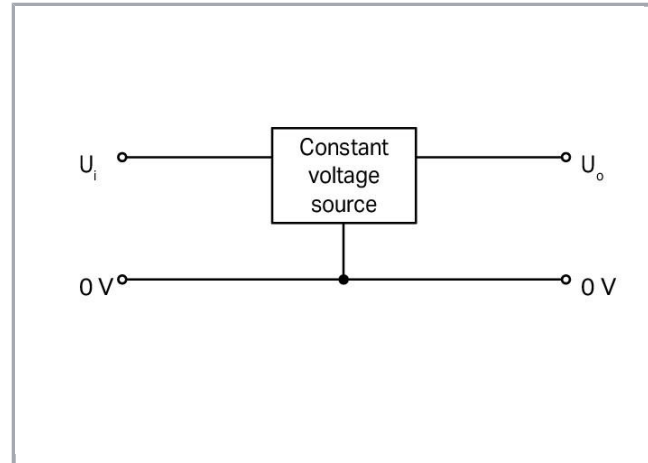

Subject to changes. Please also observe the further product documentation!

WAGO Kontakttechnik GmbH & Co. KG
Hansastr. 27
32423 Minden
Phone: +49571 887-0 | Fax: +49571 887-169
Email: info.de@wago.com | Web: www.wago.com

Do you have any questions about our products?
We are always happy to take your call at +49 (571) 887-44222.

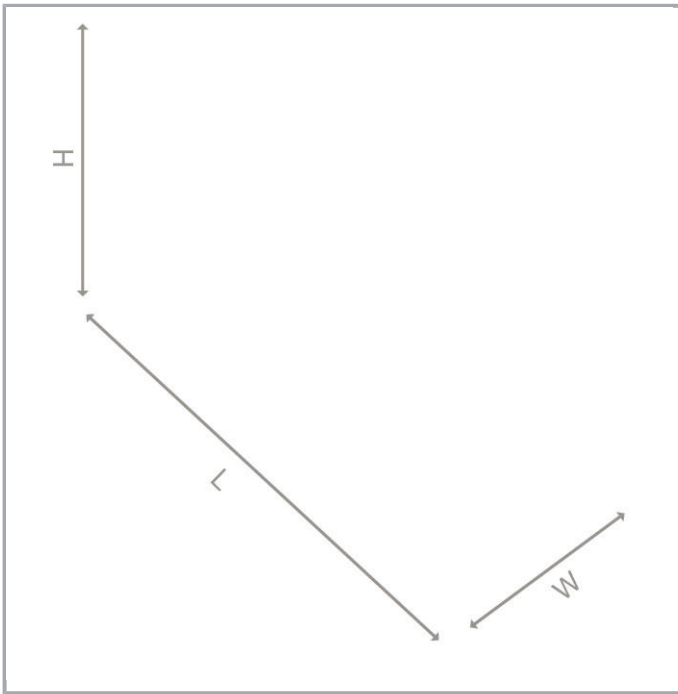

Data

Technical Data

Input

| | |
|-------------------------------|----------------|
| Input voltage range | DC 27 ... 35 V |
| Nominal mains frequency range | 0 Hz |

Output

| | |
|-------------------------------------|-------------|
| Nominal output voltage $U_{o\ nom}$ | DC 24 V |
| Output voltage range | $\pm 10\ %$ |
| Nominal output current $I_{o\ nom}$ | 3 A |

Safety and protection:

| | |
|-------------------|---------------------|
| Protection class | IP00 (per EN 60529) |
| Series connection | No |

Connection data

| | |
|-----------------------|-------------|
| Connection technology | CAGE CLAMP® |
|-----------------------|-------------|

Subject to changes. Please also observe the further product documentation!



| | |
|--------------------------------|----------------------------------------------|
| WAGO terminal | WAGO 236 Series |
| Solid conductor | 0.08 ... 2.5 mm ² / 28 ... 12 AWG |
| Fine-stranded conductor | 0.08 ... 2.5 mm ² / 28 ... 12 AWG |
| Strip length | 5 ... 6 mm / 0.2 ... 0.24 inch |
| Note (conductor cross-section) | 12 AWG: THHN, THWN |

Geometrical Data

| | |
|---------------------------------------|----------------------|
| Width | 78.5 mm / 3.091 inch |
| Height from upper-edge of DIN-35 rail | 39 mm / 1.535 inch |
| Depth | 66 mm / 2.598 inch |

Mechanical data

| | |
|------------------|------------------------|
| Type of mounting | DIN-35 rail (EN 60715) |
|------------------|------------------------|

Material Data

| | |
|-----------|----------|
| Fire load | 0.058 MJ |
| Weight | 170.7 g |

Environmental Requirements

| | |
|-----------------------------------------|---------------|
| Surrounding air (operating) temperature | -25 ... 40 °C |
| Pollution degree | 2 |

Standards and specifications

| | |
|--------------------|----|
| Conformity marking | CE |
|--------------------|----|

Commercial data

| | |
|--------------------|---------------------------|
| Product Group | 6 (Interface Electronics) |
| Packaging type | BOX |
| Country of origin | DE |
| GTIN | 4050821157557 |
| Customs Tariff No. | 85044082900 |

Counterpart







Subject to changes. Please also observe the further product documentation!

WAGO Kontakttechnik GmbH & Co. KG
 Hansastr. 27
 32423 Minden
 Phone: +49571 887-0 | Fax: +49571 887-169
 Email: info.de@wago.com | Web: www.wago.com

Do you have any questions about our products?
 We are always happy to take your call at +49 (571) 887-44222.

Compatible products

ferrule

| | | |
|-----------------------------------------------------------------------------------|--------------------------------------------------------------------------------------------------------------------------------------------------------------------------------------------|----------------------------------------------------------------|
| | Item no.: 216-201 Ferrule; Sleeve for 0.5 mm ² / 20 AWG; insulated; electro-tin plated; white | www.wago.com/216-201 |
|  | Item no.: 216-202 Ferrule; Sleeve for 0.75 mm ² / 18 AWG; insulated; electro-tin plated; gray | www.wago.com/216-202 |
| | Item no.: 216-203 Ferrule; Sleeve for 1 mm ² / AWG 18; insulated; electro-tin plated; red | www.wago.com/216-203 |
|  | Item no.: 216-204 Ferrule; Sleeve for 1.5 mm ² / AWG 16; insulated; electro-tin plated; black | www.wago.com/216-204 |
|  | Item no.: 216-221 Ferrule; Sleeve for 0.5 mm ² / 20 AWG; insulated; electro-tin plated; white | www.wago.com/216-221 |
|  | Item no.: 216-222 Ferrule; Sleeve for 0.75 mm ² / 18 AWG; insulated; electro-tin plated; gray | www.wago.com/216-222 |
|  | Item no.: 216-223 Ferrule; Sleeve for 1 mm ² / AWG 18; insulated; electro-tin plated; red | www.wago.com/216-223 |
| | Item no.: 216-224 Ferrule; Sleeve for 1.5 mm ² / AWG 16; insulated; electro-tin plated; black | www.wago.com/216-224 |
| | Item no.: 216-241 Ferrule; Sleeve for 0.5 mm ² / 20 AWG; insulated; electro-tin plated; electrolytic copper; gastight crimped; acc. to DIN 46228, Part 4/09.90; white | www.wago.com/216-241 |
| | Item no.: 216-242 Ferrule; Sleeve for 0.75 mm ² / 18 AWG; insulated; electro-tin plated; electrolytic copper; gastight crimped; acc. to DIN 46228, Part 4/09.90; gray | www.wago.com/216-242 |
| | Item no.: 216-243 Ferrule; Sleeve for 1 mm ² / AWG 18; insulated; electro-tin plated; electrolytic copper; gastight crimped; acc. to DIN 46228, Part 4/09.90; red | www.wago.com/216-243 |
|  | Item no.: 216-244 Ferrule; Sleeve for 1.5 mm ² / AWG 16; insulated; electro-tin plated; electrolytic copper; gastight crimped; acc. to DIN 46228, Part 4/09.90; black | www.wago.com/216-244 |
|  | Item no.: 216-262 Ferrule; Sleeve for 0.75 mm ² / 18 AWG; insulated; electro-tin plated; electrolytic copper; gastight crimped; acc. to DIN 46228, Part 4/09.90; gray | www.wago.com/216-262 |
| | Item no.: 216-263 Ferrule; Sleeve for 1 mm ² / AWG 18; insulated; electro-tin plated; electrolytic copper; gastight crimped; acc. to DIN 46228, Part 4/09.90; red | www.wago.com/216-263 |
| | Item no.: 216-264 | |

Subject to changes. Please also observe the further product documentation!



Ferrule; Sleeve for 1.5 mm² / AWG 16; insulated; electro-tin plated; electrolytic copper; gastight crimped; acc. to DIN 46228, Part 4/09.90; black

www.wago.com/216-264

Item no.: 216-284

Ferrule; Sleeve for 1.5 mm² / AWG 16; insulated; electro-tin plated; electrolytic copper; gastight crimped; acc. to DIN 46228, Part 4/09.90; black

www.wago.com/216-284

Item no.: 216-301

Ferrule; Sleeve for 0.25 mm² / AWG 24; insulated; electro-tin plated; yellow

www.wago.com/216-301



Item no.: 216-302

Ferrule; Sleeve for 0.34 mm² / 22 AWG; insulated; electro-tin plated; green

www.wago.com/216-302

Item no.: 216-321

Ferrule; Sleeve for 0.25 mm² / AWG 24; insulated; electro-tin plated; yellow

www.wago.com/216-321



Item no.: 216-322

Ferrule; Sleeve for 0.34 mm² / 22 AWG; insulated; electro-tin plated; green

www.wago.com/216-322

tools



Item no.: 210-720

Operating tool; Blade: 3.5 x 0.5 mm; with a partially insulated shaft

www.wago.com/210-720

Marking accessories

Item no.: 210-831

Marking strips; on reel; 2.3 mm wide; plain; Self-adhesive; white

www.wago.com/210-831



Item no.: 210-832

Marking strips; on reel; 3 mm wide; plain; Self-adhesive; white

www.wago.com/210-832

Downloads

Documentation

Instruction Leaflet

pdf
1.3 MB
Download

Additional Information

Disposal; Electrical and electronic equipment, Packaging V 1.0.0 pdf 265.8 kB Download

CAD/CAE-Data

CAE data

EPLAN Data Portal 289-907 URL Download

WSCAD Universe 289-907 URL Download

Subject to changes. Please also observe the further product documentation!

WAGO Kontakttechnik GmbH & Co. KG
Hansastr. 27
32423 Minden
Phone: +49571 887-0 | Fax: +49571 887-169
Email: info.de@wago.com | Web: www.wago.com

Do you have any questions about our products?
We are always happy to take your call at +49 (571) 887-44222.



Installation Notes

Subject to changes. Please also observe the further product documentation!

WAGO Kontakttechnik GmbH & Co. KG
Hansastr. 27
32423 Minden
Phone: +49571 887-0 | Fax: +49571 887-169
Email: info.de@wago.com | Web: www.wago.com

Do you have any questions about our products?
We are always happy to take your call at +49 (571) 887-44222.