

RoHS Compliant

Color:

Subject to changes. Please also observe the further product documentation!

WAGO Kontakttechnik GmbH & Co. KG  
Hansastr. 27  
32423 Minden  
Phone: +49571 887-0 | Fax: +49571 887-169  
Email: [info.de@wago.com](mailto:info.de@wago.com) | Web: [www.wago.com](http://www.wago.com)

Do you have any questions about our products?  
We are always happy to take your call at +49 (571) 887-44222.

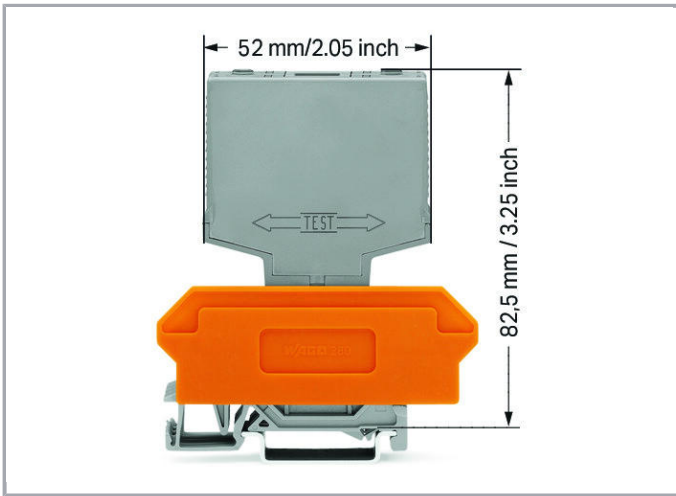

## Data

### Technical Data

#### Control circuit

Nominal input voltage $U_N$	DC 5 V
Input voltage range (high level)	DC 2 ... 6.25 V
Nominal input current at $U_N$	14 mA
Input current range	3.3 ... 18.5 mA

#### Load circuit:

Circuit type	3-conductor termination High-side switching
Limiting continuous current	0.5 A
Nominal output voltage	DC 24 V
Output voltage range	DC 20 ... 30 V
Max. voltage drop at output	$\leq$ DC 1.2 V
Leakage current at nominal voltage	$\leq$ 2 $\mu$ A
Max. output (reverse current)	12 mA
Turn-on time	$\leq$ 5 $\mu$ s
Drop-out time	$\leq$ 10 $\mu$ s
Switching frequency	$\leq$ 25 kHz

#### Signaling

Status indication	LED red
-------------------	---------

Subject to changes. Please also observe the further product documentation!

## Safety and protection:

Pollution degree	2
Dielectric strength, control/load circuit (AC, 1 min)	2.5 kVrms
Protection class	IP20

## Geometrical Data

Width	15 mm / 0.591 inch
Height from upper-edge of DIN-35 rail	82.5 mm / 3.25 inch
Depth	52 mm / 2.047 inch

## Mechanical data

Type of mounting	Pluggable module for carrier terminal blocks
------------------	--

## Material Data

Color	gray
Fire load	0.324 MJ
Weight	18.5 g

## Environmental Requirements

Surrounding air (operating) temperature at $U_N$	-25 ... 70 °C
Surrounding air (storage) temperature	-25 ... 70 °C
Processing temperature	-25 ... +50 °C

## Standards and specifications

Standards/specifications	EN 60664-1
--------------------------	------------

## Commercial data

Product Group	6 (Interface Electronics)
Packaging type	BOX
Country of origin	DE
GTIN	4050821371472
Customs Tariff No.	85365005000

## Counterpart



Subject to changes. Please also observe the further product documentation!

WAGO Kontakttechnik GmbH & Co. KG  
Hansastr. 27  
32423 Minden  
Phone: +49571 887-0 | Fax: +49571 887-169  
Email: [info.de@wago.com](mailto:info.de@wago.com) | Web: [www.wago.com](http://www.wago.com)

Do you have any questions about our products?  
We are always happy to take your call at +49 (571) 887-44222.

## Compatible products

### Marking accessories

<b>Item no.: 209-701</b> WSB marking card; as card; not stretchable; plain; snap-on type; white	<a href="http://www.wago.com/209-701">www.wago.com/209-701</a>
<b>Item no.: 209-701/000-002</b> WSB marking card; as card; not stretchable; plain; snap-on type; yellow	<a href="http://www.wago.com/209-701/000-002">www.wago.com/209-701/000-002</a>
<b>Item no.: 209-701/000-005</b> WSB marking card; as card; not stretchable; plain; snap-on type; red	<a href="http://www.wago.com/209-701/000-005">www.wago.com/209-701/000-005</a>
<b>Item no.: 209-701/000-006</b> WSB marking card; as card; not stretchable; plain; snap-on type; blue	<a href="http://www.wago.com/209-701/000-006">www.wago.com/209-701/000-006</a>
<b>Item no.: 209-701/000-007</b> WSB marking card; as card; not stretchable; plain; snap-on type; gray	<a href="http://www.wago.com/209-701/000-007">www.wago.com/209-701/000-007</a>
<b>Item no.: 209-701/000-012</b> WSB marking card; as card; not stretchable; plain; snap-on type; orange	<a href="http://www.wago.com/209-701/000-012">www.wago.com/209-701/000-012</a>
 <b>Item no.: 209-701/000-017</b> WSB marking card; as card; not stretchable; plain; snap-on type; light green	<a href="http://www.wago.com/209-701/000-017">www.wago.com/209-701/000-017</a>
 <b>Item no.: 209-701/000-023</b> WSB marking card; as card; not stretchable; plain; snap-on type; green	<a href="http://www.wago.com/209-701/000-023">www.wago.com/209-701/000-023</a>
 <b>Item no.: 209-701/000-024</b> WSB marking card; as card; not stretchable; plain; snap-on type; violet	<a href="http://www.wago.com/209-701/000-024">www.wago.com/209-701/000-024</a>

### General accessories

<b>Item no.: 280-609</b> Terminal block for pluggable modules; 6-pole; with 4-conductor terminal blocks; with orange separator; for DIN-rail 35 x 15 and 35 x 7.5; 2.5 mm <sup>2</sup> ; CAGE CLAMP®; 2,50 mm <sup>2</sup> ; gray	<a href="http://www.wago.com/280-609">www.wago.com/280-609</a>
<b>Item no.: 280-619</b> Terminal block for pluggable modules; 6-pole; with 2-conductor terminal blocks; with orange separator; for DIN-rail 35 x 15 and 35 x 7.5; 2.5 mm <sup>2</sup> ; CAGE CLAMP®; 2,50 mm <sup>2</sup> ; gray	<a href="http://www.wago.com/280-619">www.wago.com/280-619</a>
<b>Item no.: 280-763</b> Terminal block for pluggable modules; 6-pole; with 4-conductor terminal blocks; with marker carrier; with orange separator; for DIN-rail 35 x 15 and 35 x 7.5; 2.5 mm <sup>2</sup> ; CAGE CLAMP®; 2,50 mm <sup>2</sup> ; gray	<a href="http://www.wago.com/280-763">www.wago.com/280-763</a>

Subject to changes. Please also observe the further product documentation!

## Downloads

### Documentation

#### Instruction Leaflet

pdf  
1.3 MB

Download

### Additional Information

Disposal; Electrical and electronic equipment, Packaging

V 1.0.0

pdf  
265.8 kB

Download

## CAD/CAE-Data

### CAE data

WSCAD Universe 286-752/002-000

URL

Download

## Installation Notes

### Assembly

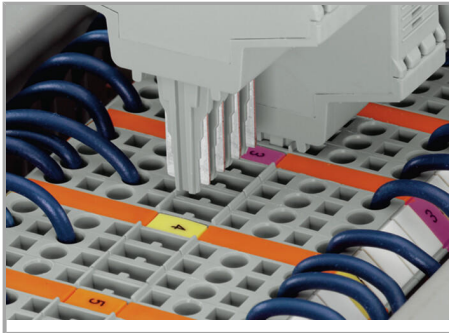

Coding ensures correct polarity

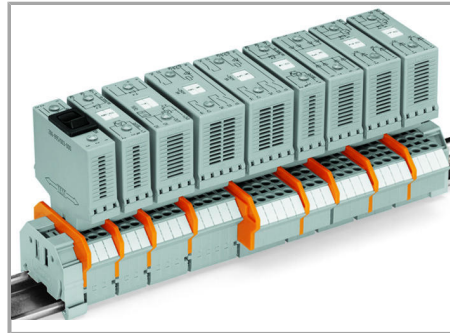

Pluggable electronic modules, for application on 2- or 4-conductor carrier terminal blocks

### Marking

Subject to changes. Please also observe the further product documentation!

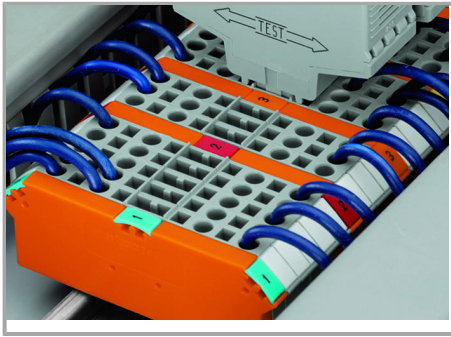

Marking using WMB Multi markers

### Testing



Easy testing at touchproof contacts

Subject to changes. Please also observe the further product documentation!