

Data sheet | Item number: 286-516

Relay module; Nominal input voltage: 230 VAC; 2 changeover contacts;
Limiting continuous current: 7 A; Red status indicator; Module width: 15 mm;
gray

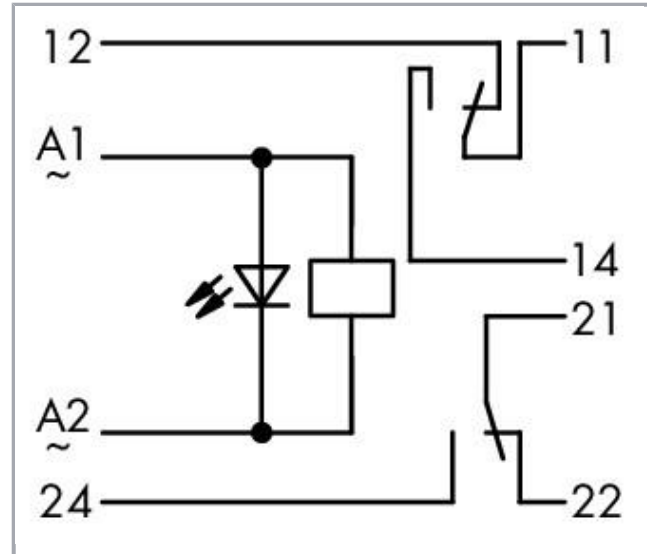

www.wago.com/286-516



RoHS Compliant

[BOMcheck.net](https://www.bomcheck.net)

Color: ■

Subject to changes. Please also observe the further product documentation!

WAGO Kontakttechnik GmbH & Co. KG
Hansastr. 27
32423 Minden
Phone: +49571 887-0 | Fax: +49571 887-169
Email: info.de@wago.com | Web: www.wago.com

Do you have any questions about our products?
We are always happy to take your call at +49 (571) 887-44222.

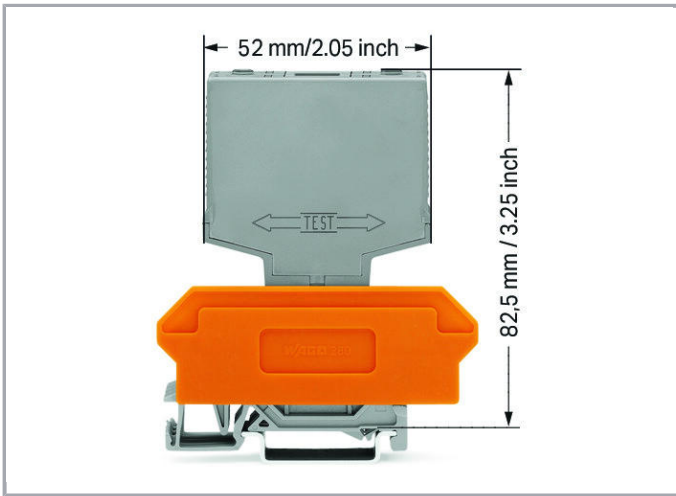

Data

Technical Data

Control circuit

Nominal input voltage U_N	AC 230 V
Input voltage range	$\pm 10\%$
Nominal input current at U_N	5.5 mA

Load circuit:

Number of changeover/switchover contacts	2
Contact material (relay)	AgNi 0.15
Limiting continuous current	7 A
Max. switching voltage	AC 250 V
Max. switching power (resistive)	AC 1750 VA
Pull-in time (typ.)	15 ms
Drop-out time (typ.)	3 ms
Bounce time (typ.)	2 ms
Electrical life (N.O.; resistive load; 23 °C)	100×10^3 switching operations
Mechanical life	30×10^6 switching operations

Signaling

Status indication	LED red
-------------------	---------

Subject to changes. Please also observe the further product documentation!

Safety and protection:

Rated voltage	250 V
Rated impulse voltage	4 kV
Pollution degree	2
Dielectric strength, control/load circuit (AC, 1 min)	2 kVrms
Dielectric strength open contact (AC, 1 min)	1 kVrms
Dielectric strength, load/load circuit (AC, 1 min)	1.5 kVrms
Protection class	IP20

Geometrical Data

Width	20 mm / 0.787 inch
Height from upper-edge of DIN-35 rail	82.5 mm / 3.248 inch
Depth	52 mm / 2.047 inch

Mechanical data

Type of mounting	Pluggable module for carrier terminal blocks
------------------	----------------------------------------------

Material Data

Color	gray
Fire load	0.391 MJ
Weight	35.2 g

Environmental Requirements

Surrounding air (operating) temperature at U_N	-25 ... 40 °C
Surrounding air (storage) temperature	-25 ... 70 °C
Processing temperature	-25 ... +50 °C

Standards and specifications

Standards/specifications	EN 60664-1
--------------------------	------------

Commercial data

Product Group	6 (Interface Electronics)
Packaging type	BOX
Country of origin	DE
GTIN	4017332291507

Subject to changes. Please also observe the further product documentation!









Customs Tariff No.

85364900990

Counterpart

Compatible products

Marking accessories

	Item no.: 209-701 WSB marking card; as card; not stretchable; plain; snap-on type; white	www.wago.com/209-701
	Item no.: 209-701/000-002 WSB marking card; as card; not stretchable; plain; snap-on type; yellow	www.wago.com/209-701/000-002
	Item no.: 209-701/000-005 WSB marking card; as card; not stretchable; plain; snap-on type; red	www.wago.com/209-701/000-005
	Item no.: 209-701/000-006 WSB marking card; as card; not stretchable; plain; snap-on type; blue	www.wago.com/209-701/000-006
	Item no.: 209-701/000-007 WSB marking card; as card; not stretchable; plain; snap-on type; gray	www.wago.com/209-701/000-007
	Item no.: 209-701/000-012 WSB marking card; as card; not stretchable; plain; snap-on type; orange	www.wago.com/209-701/000-012
	Item no.: 209-701/000-017 WSB marking card; as card; not stretchable; plain; snap-on type; light green	www.wago.com/209-701/000-017
	Item no.: 209-701/000-023 WSB marking card; as card; not stretchable; plain; snap-on type; green	www.wago.com/209-701/000-023
	Item no.: 209-701/000-024 WSB marking card; as card; not stretchable; plain; snap-on type; violet	www.wago.com/209-701/000-024

General accessories

	Item no.: 280-628 Terminal block for pluggable modules; 8-pole; with 4-conductor terminal blocks; with orange separator; for DIN-rail 35 x 15 and 35 x 7.5; 2.5 mm ² ; CAGE CLAMP®; 2,50 mm ² ; gray	www.wago.com/280-628
	Item no.: 280-638 Terminal block for pluggable modules; 8-pole; with 2-conductor terminal blocks; with orange separator;	www.wago.com/280-638

Subject to changes. Please also observe the further product documentation!

for DIN-rail 35 x 15 and 35 x 7.5; 2.5 mm²; CAGE CLAMP®; 2,50 mm²; gray

Item no.: 280-764

Terminal block for pluggable modules; 8-pole; with 4-conductor terminal blocks; with marker carrier; with orange separator; for DIN-rail 35 x 15 and 35 x 7.5; 2.5 mm²; CAGE CLAMP®; 2,50 mm²; gray

www.wago.com/280-764

Downloads

Documentation

Instruction Leaflet

pdf
1.3 MB
Download

Additional Information

Disposal; Electrical and electronic equipment, Packaging

V 1.0.0

pdf
265.8 kB
Download

CAD/CAE-Data

CAD data

2D/3D Models 286-516

URL
Download

CAE data

WSCAD Universe 286-516

URL
Download

Installation Notes

Assembly

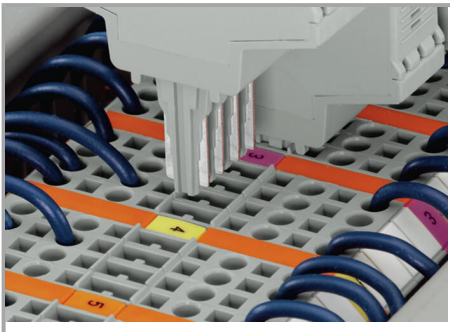

Coding ensures correct polarity

Subject to changes. Please also observe the further product documentation!

WAGO Kontakttechnik GmbH & Co. KG

Hansastr. 27

32423 Minden

Phone: +49571 887-0 | Fax: +49571 887-169

Email: info.de@wago.com | Web: www.wago.com

Do you have any questions about our products?

We are always happy to take your call at +49 (571) 887-44222.

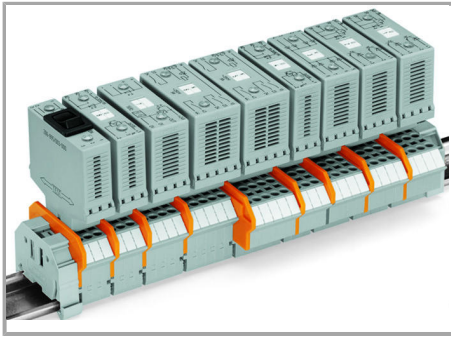

Pluggable electronic modules, for application on 2- or 4-conductor carrier terminal blocks

Marking

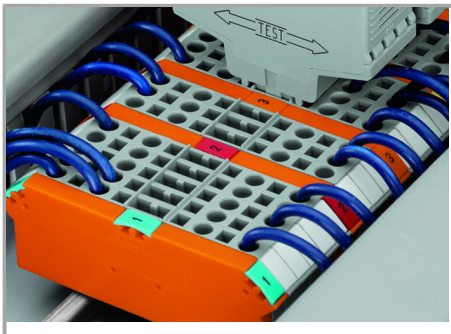

Marking using WMB Multi markers

Testing



Easy testing at touchproof contacts

Subject to changes. Please also observe the further product documentation!