

Data sheet | Item number: 282-697

2-conductor disconnect terminal block; with test option; orange disconnect link; for DIN-rail 35 x 15 and 35 x 7.5; 6 mm²; CAGE CLAMP®; 6,00 mm²; gray

www.wago.com/282-697

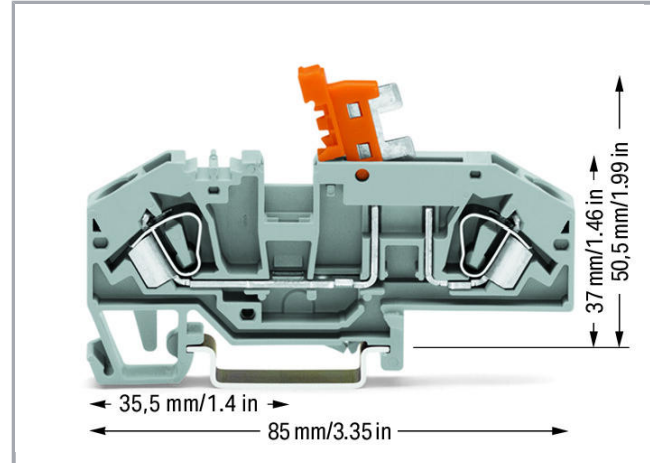
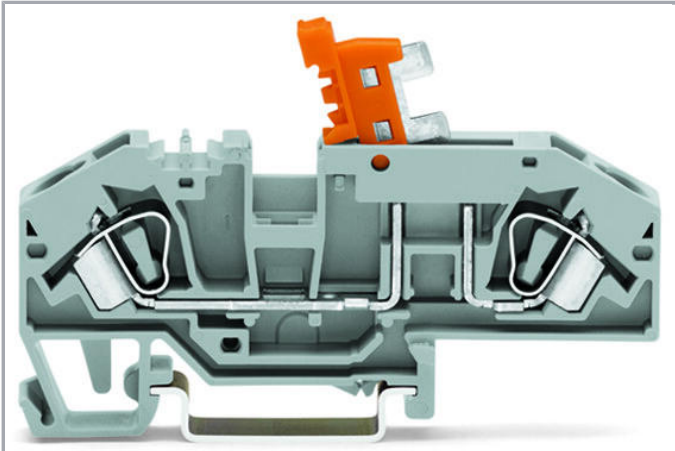

RoHS Compliant

[BOMcheck.net](https://www.bomcheck.net)

Color: ■

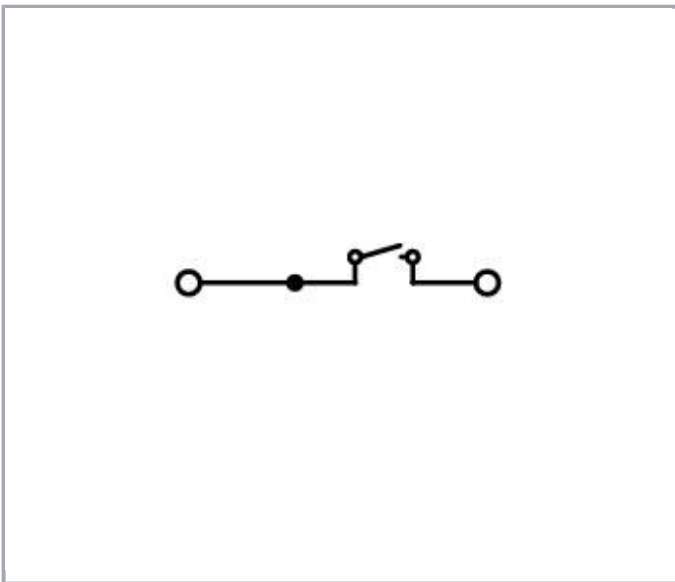

Data

Electrical data

Subject to changes. Please also observe the further product documentation!

WAGO Kontakttechnik GmbH & Co. KG
Hansastr. 27
32423 Minden
Phone: +49571 887-0 | Fax: +49571 887-169
Email: info.de@wago.com | Web: www.wago.com

Do you have any questions about our products?
We are always happy to take your call at +49 (571) 887-44222.

Ratings per IEC/EN 60664-1

Rated voltage (III / 3)	400 V
Rated impulse voltage (III / 3)	6 kV
Rated current	30 A
Legend (ratings)	(III / 3) $\hat{=}$ Overvoltage category III / Pollution degree 3

Connection data

Connection technology	CAGE CLAMP®
Actuation type	Operating tool
Connectable conductor materials	Copper
Solid conductor	0,2 ... 6 mm ² / 24 ... 10 AWG
Fine-stranded conductor	0,2 ... 6 mm ² / 24 ... 10 AWG
Strip length	12 ... 13 mm / 0.47 ... 0.51 inch
Total number of connection points	2
Total number of potentials	2
Number of levels	1
Type of wiring	Front-entry wiring

Geometrical Data

Width	8 mm / 0.315 inch
Height from upper-edge of DIN-35 rail	37 mm / 1.457 inch
Depth	85 mm / 3.346 inch

Mechanical data

Design	angled
Type of mounting	DIN-35 rail
Marking level	Center marking

Material Data

Color	gray
Insulating material	Polyamide 66 (PA 66)
Fire load	0.31 MJ
Weight	18.7 g



Subject to changes. Please also observe the further product documentation!

Commercial data



Product Group	1 (Rail Mounted Terminal Blocks)
Packaging type	BOX
Country of origin	CN
GTIN	4050821234524
Customs Tariff No.	85365080900

Approvals / Certificates

Country specific Approvals

Logo	Approval	Additional Approval Text	Certificate name
	CCA DEKRA Certification B.V.	EN 60947	2195540.01
	CCA DEKRA Certification B.V.	EN 60947	NTR NL-7522
	CSA DEKRA Certification B.V.	C22.2 No. 158	1505033

Ship Approvals

Logo	Approval	Additional Approval Text	Certificate name
	ABS American Bureau of Shipping	EN 60947	20-HG1941090-PDA
	BV Bureau Veritas S.A.	EN 60947	07436/E0 BV
	DNV GL Det Norske Veritas, Germanischer Lloyd	-	TAE00001V2
	LR	EN 60947	91/20112

Subject to changes. Please also observe the further product documentation!



Lloyds Register

(E9)



UL-Approvals

Logo	Approval	Additional Approval Text	Certificate name
	UR Underwriters Laboratories Inc.	UL 1059	E45172

Counterpart

Compatible products



Test Accessories

	Item no.: 209-170 Test plug adapter; 8.3 mm wide; for 4 mm Ø test plugs; suitable for 1.5 mm ² - 10 mm ² tbs; gray	www.wago.com/209-170
	Item no.: 210-136 Test plug; 2 mm Ø; with 500 mm cable; red	www.wago.com/210-136
assembling		
	Item no.: 209-106 Mounting carrier; for isolated mounting on DIN 35 rails; gray	www.wago.com/209-106
	Item no.: 709-154 Cover; Type 2; suitable for cover carrier, type 2; 1 m long; transparent	www.wago.com/709-154
ferrule		
	Item no.: 216-262 Ferrule; Sleeve for 0.75 mm ² / 18 AWG; insulated; electro-tin plated; electrolytic copper; gastight crimped; acc. to DIN 46228, Part 4/09.90; gray	www.wago.com/216-262
	Item no.: 216-263	







Subject to changes. Please also observe the further product documentation!

WAGO Kontakttechnik GmbH & Co. KG
 Hansastr. 27
 32423 Minden
 Phone: +49571 887-0 | Fax: +49571 887-169
 Email: info.de@wago.com | Web: www.wago.com







Do you have any questions about our products?
 We are always happy to take your call at +49 (571) 887-44222.

	Ferrule; Sleeve for 1 mm ² / AWG 18; insulated; electro-tin plated; electrolytic copper; gastight crimped; acc. to DIN 46228, Part 4/09.90; red	www.wago.com/216-263
	Item no.: 216-264 Ferrule; Sleeve for 1.5 mm ² / AWG 16; insulated; electro-tin plated; electrolytic copper; gastight crimped; acc. to DIN 46228, Part 4/09.90; black	www.wago.com/216-264
	Item no.: 216-266 Ferrule; Sleeve for 2.5 mm ² / AWG 14; insulated; electro-tin plated; electrolytic copper; gastight crimped; acc. to DIN 46228, Part 4/09.90; blue	www.wago.com/216-266
	Item no.: 216-267 Ferrule; Sleeve for 4 mm ² / AWG 12; insulated; electro-tin plated; electrolytic copper; gastight crimped; acc. to DIN 46228, Part 4/09.90; gray	www.wago.com/216-267
tools		
	Item no.: 210-721 Operating tool; Blade: 5.5 x 0.8 mm; with a partially insulated shaft	www.wago.com/210-721
End plate		
	Item no.: 282-333 End plate; 2 mm thick	www.wago.com/282-333
	Item no.: 282-334 End plate; 2 mm thick; gray	www.wago.com/282-334
General accessories		
	Item no.: 209-143 Group marker carrier; gray	www.wago.com/209-143
	Item no.: 209-144 Group marker carrier; gray	www.wago.com/209-144
	Item no.: 709-310 B-type test plug module; modular; suitable for all WAGO 282 Series rail-mounted terminal blocks with jumper slots; 6,00 mm ² ; gray	www.wago.com/709-310
	Item no.: 709-311 B-type spacer module; modular; e.g., for bridging commoned terminal blocks; gray	www.wago.com/709-311
Marking accessories		
	Item no.: 2009-115 WMB-Inline; for Smart Printer; 1500 pieces on roll; stretchable 5 - 5.2 mm; plain; snap-on type; white	www.wago.com/2009-115
	Item no.: 2009-115/000-002 WMB-Inline; for Smart Printer; 1500 pieces on roll; stretchable 5 - 5.2 mm; plain; snap-on type; yellow	www.wago.com/2009-115/000-002
	Item no.: 2009-115/000-006 WMB-Inline; for Smart Printer; 1500 pieces on roll; stretchable 5 - 5.2 mm; plain; snap-on type; white	www.wago.com/2009-115/000-006
	Item no.: 2009-115/000-007 WMB-Inline; for Smart Printer; 1500 pieces on roll; stretchable 5 - 5.2 mm; plain; snap-on type; gray	www.wago.com/2009-115/000-007

Subject to changes. Please also observe the further product documentation!

	Item no.: 2009-115/000-012 WMB-Inline; for Smart Printer; 1500 pieces on roll; stretchable 5 - 5.2 mm; plain; snap-on type; white	www.wago.com/2009-115/000-012
	Item no.: 2009-115/000-017 WMB-Inline; for Smart Printer; 1500 pieces on roll; stretchable 5 - 5.2 mm; plain; snap-on type; white	www.wago.com/2009-115/000-017
	Item no.: 2009-115/000-023 WMB-Inline; for Smart Printer; 1500 pieces on roll; stretchable 5 - 5.2 mm; plain; snap-on type; green	www.wago.com/2009-115/000-023
	Item no.: 2009-115/000-024 WMB-Inline; for Smart Printer; 1500 pieces on roll; stretchable 5 - 5.2 mm; plain; snap-on type; white	www.wago.com/2009-115/000-024
	Item no.: 249-105 Group marker carrier; gray	www.wago.com/249-105
	Item no.: 793-501 WMB marking card; as card; not stretchable; plain; snap-on type; white	www.wago.com/793-501
	Item no.: 793-501/000-002 WMB marking card; as card; not stretchable; plain; snap-on type; yellow	www.wago.com/793-501/000-002
	Item no.: 793-501/000-005 WMB marking card; as card; not stretchable; plain; snap-on type; red	www.wago.com/793-501/000-005
	Item no.: 793-501/000-006 WMB marking card; as card; not stretchable; plain; snap-on type; blue	www.wago.com/793-501/000-006
	Item no.: 793-501/000-007 WMB marking card; as card; not stretchable; plain; snap-on type; gray	www.wago.com/793-501/000-007
	Item no.: 793-501/000-012 WMB marking card; as card; not stretchable; plain; snap-on type; orange	www.wago.com/793-501/000-012
	Item no.: 793-501/000-017 WMB marking card; as card; not stretchable; plain; snap-on type; light green	www.wago.com/793-501/000-017
	Item no.: 793-501/000-023 WMB marking card; as card; not stretchable; plain; snap-on type; green	www.wago.com/793-501/000-023
	Item no.: 793-501/000-024 WMB marking card; as card; not stretchable; plain; snap-on type; violet	www.wago.com/793-501/000-024

Subject to changes. Please also observe the further product documentation!

	<p>Item no.: 793-5501 WMB marking card; as card; for terminal block width 5 - 17.5 mm; stretchable 5 - 5.2 mm; plain; snap-on type; white</p>	www.wago.com/793-5501
	<p>Item no.: 793-5501/000-002 WMB marking card; as card; for terminal block width 5 - 17.5 mm; stretchable 5 - 5.2 mm; plain; snap-on type; yellow</p>	www.wago.com/793-5501/000-002
	<p>Item no.: 793-5501/000-005 WMB marking card; as card; for terminal block width 5 - 17.5 mm; stretchable 5 - 5.2 mm; plain; snap-on type; red</p>	www.wago.com/793-5501/000-005
	<p>Item no.: 793-5501/000-006 WMB marking card; as card; for terminal block width 5 - 17.5 mm; stretchable 5 - 5.2 mm; plain; snap-on type; blue</p>	www.wago.com/793-5501/000-006
	<p>Item no.: 793-5501/000-007 WMB marking card; as card; for terminal block width 5 - 17.5 mm; stretchable 5 - 5.2 mm; plain; snap-on type; gray</p>	www.wago.com/793-5501/000-007
	<p>Item no.: 793-5501/000-012 WMB marking card; as card; for terminal block width 5 - 17.5 mm; stretchable 5 - 5.2 mm; plain; snap-on type; orange</p>	www.wago.com/793-5501/000-012
	<p>Item no.: 793-5501/000-014 WMB marking card; as card; for terminal block width 5 - 17.5 mm; stretchable 5 - 5.2 mm; plain; snap-on type; brown</p>	www.wago.com/793-5501/000-014
	<p>Item no.: 793-5501/000-017 WMB marking card; as card; for terminal block width 5 - 17.5 mm; stretchable 5 - 5.2 mm; plain; snap-on type; green</p>	www.wago.com/793-5501/000-017
	<p>Item no.: 793-5501/000-023 WMB marking card; as card; for terminal block width 5 - 17.5 mm; stretchable 5 - 5.2 mm; plain; snap-on type; light green</p>	www.wago.com/793-5501/000-023
	<p>Item no.: 793-5501/000-024 WMB marking card; as card; for terminal block width 5 - 17.5 mm; stretchable 5 - 5.2 mm; plain; snap-on type; violet</p>	www.wago.com/793-5501/000-024
Protective Warning Marker		
	<p>Item no.: 282-405 Protective warning marker; with high-voltage symbol, black; for 5 terminal blocks; yellow</p>	www.wago.com/282-405
protection		
	<p>Item no.: 282-415 Protective warning marker; with high-voltage symbol, black; for 5 terminal blocks; yellow</p>	www.wago.com/282-415
Jumper		
	<p>Item no.: 210-103 Wire commoning chain; insulated; 50 connections; black</p>	www.wago.com/210-103
	<p>Item no.: 210-123</p>	

Subject to changes. Please also observe the further product documentation!

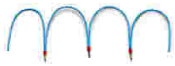

Wire commoning chain; insulated; 50 connections

www.wago.com/210-123



Item no.: 282-402

Adjacent jumper; insulated; Nominal current 41 A

www.wago.com/282-402



Item no.: 282-409

Alternate jumper; insulated; Nominal current 41 A; gray

www.wago.com/282-409



Item no.: 282-422

Adjacent jumper; insulated; Nominal current 41 A; yellow-green

www.wago.com/282-422

Item no.: 282-424

Adjacent jumper; insulated; Nominal current 41 A; orange

www.wago.com/282-424

Item no.: 709-110

Wire commoning chain; insulated; 4 connections; 3 x 110 mm; black

www.wago.com/709-110

Item no.: 709-111

Wire commoning chain; insulated; 3 connections; 2 x 120 mm; black

www.wago.com/709-111

Item no.: 709-112

Wire commoning chain; insulated; 3 connections; 2 x 170 mm; black

www.wago.com/709-112

Carrier rail

Item no.: 210-112

Steel carrier rail; 35 x 7.5 mm; 1 mm thick; 2 m long; slotted; according to EN 60715; "Hole width 25 mm

www.wago.com/210-112

Item no.: 210-113

Steel carrier rail; 35 x 7.5 mm; 1 mm thick; 2 m long; unslotted; according to EN 60715

www.wago.com/210-113

Item no.: 210-114

Steel carrier rail; 35 x 15 mm; 1.5 mm thick; 2 m long; unslotted; similar to EN 60715

www.wago.com/210-114



Item no.: 210-115

Steel carrier rail; 35 x 7.5 mm; 1 mm thick; 2 m long; slotted; according to EN 60715; "Hole width 18 mm

www.wago.com/210-115

Item no.: 210-118

Steel carrier rail; 35 x 15 mm; 2.3 mm thick; 2 m long; unslotted; according to EN 60715

www.wago.com/210-118

Item no.: 210-196

Aluminum carrier rail; 35 x 8.2 mm; 1.6 mm thick; 2 m long; unslotted; similar to EN 60715; silver-colored

www.wago.com/210-196

Item no.: 210-197

Steel carrier rail; 35 x 15 mm; 1.5 mm thick; 2 m long; slotted; similar to EN 60715

www.wago.com/210-197



Item no.: 210-198

Copper carrier rail; 35 x 15 mm; 2.3 mm thick; 2 m long; unslotted; according to EN 60715; copper-colored

www.wago.com/210-198



Item no.: 210-504

Steel carrier rail; 35 x 7.5 mm; 1 mm thick; 2 m long; slotted; galvanized; according to EN 60715

www.wago.com/210-504

Subject to changes. Please also observe the further product documentation!

WAGO Kontakttechnik GmbH & Co. KG

Hansastr. 27

32423 Minden

Phone: +49571 887-0 | Fax: +49571 887-169

Email: info.de@wago.com | Web: www.wago.com

Do you have any questions about our products?

We are always happy to take your call at +49 (571) 887-44222.

Item no.: 210-505

Steel carrier rail; 35 x 7.5 mm; 1 mm thick; 2 m long; unslotted; galvanized; according to EN 60715

www.wago.com/210-505



Item no.: 210-506

Steel carrier rail; 35 x 15 mm; 1.5 mm thick; 2 m long; unslotted; galvanized; similar to EN 60715

www.wago.com/210-506



Item no.: 210-508

Steel carrier rail; 35 x 15 mm; 1.5 mm thick; 2 m long; slotted; galvanized; similar to EN 60715

www.wago.com/210-508

Downloads

Documentation

Additional Information

Technical explanations	Apr 3, 2019	pdf 2.1 MB	Download
------------------------	-------------	---------------	----------

CAD/CAE-Data

CAD data

2D/3D Models 282-697	URL	Download
----------------------	-----	----------

CAE data

EPLAN Data Portal 282-697	URL	Download
---------------------------	-----	----------

WSCAD Universe 282-697	URL	Download
------------------------	-----	----------

Installation Notes

Testing

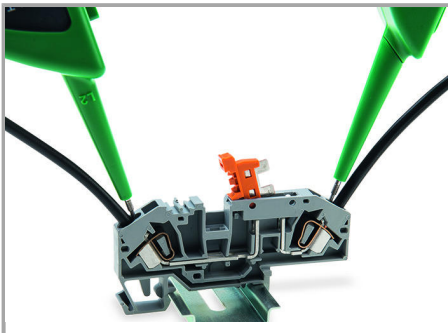

Testing via conductor entry.

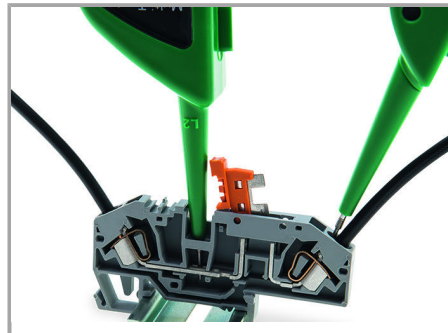

Testing via jumper contact slot.

Subject to changes. Please also observe the further product documentation!

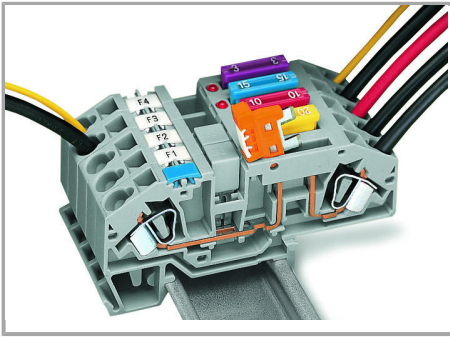

Power supply via disconnect link –
disconnecting all outputs.

Subject to changes. Please also observe the further product documentation!