

**Data sheet | Item number: 282-681**

3-conductor through terminal block; 6 mm<sup>2</sup>; center marking; for DIN-rail 35 x 15 and 35 x 7.5; CAGE CLAMP®; 6,00 mm<sup>2</sup>; gray

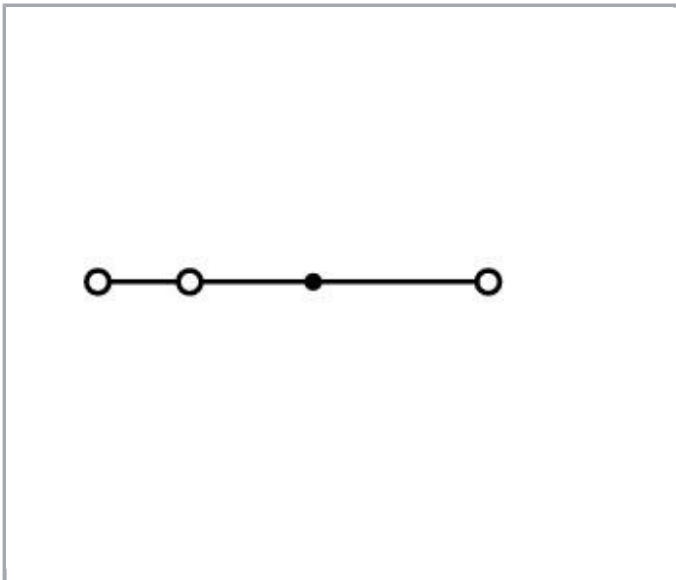

[www.wago.com/282-681](http://www.wago.com/282-681)

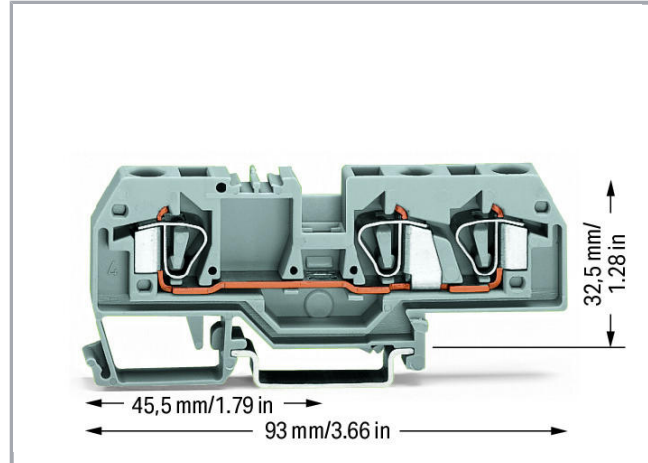
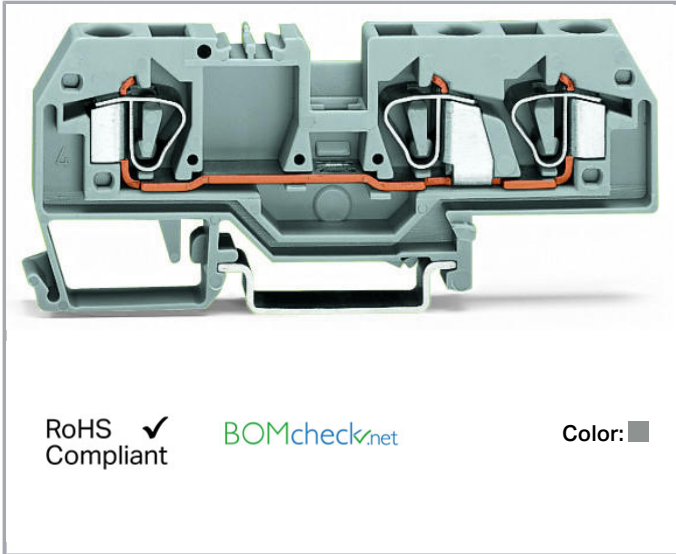

**Data**

**Electrical data**

**Ratings per IEC/EN 60664-1**

Ratings per

IEC/EN 60947-7-1

Subject to changes. Please also observe the further product documentation!

WAGO Kontakttechnik GmbH & Co. KG  
Hansastr. 27  
32423 Minden  
Phone: +49571 887-0 | Fax: +49571 887-169  
Email: [info.de@wago.com](mailto:info.de@wago.com) | Web: [www.wago.com](http://www.wago.com)

Do you have any questions about our products?  
We are always happy to take your call at +49 (571) 887-44222.



Rated voltage (III / 3)	800 V
Rated impulse voltage (III / 3)	8 kV
Rated current	41 A
Legend (ratings)	(III / 3) ≙ Overvoltage category III / Pollution degree 3

### Connection data

Connection technology	CAGE CLAMP®
Actuation type	Operating tool
Connectable conductor materials	Copper
Solid conductor	0,2 ... 6 mm <sup>2</sup> / 24 ... 10 AWG
Fine-stranded conductor	0,2 ... 6 mm <sup>2</sup> / 24 ... 10 AWG
Strip length	12 ... 13 mm / 0.47 ... 0.51 inch
Total number of connection points	3
Total number of potentials	1
Number of levels	1
Type of wiring	Front-entry wiring

### Geometrical Data

Width	8 mm / 0.315 inch
Height from upper-edge of DIN-35 rail	32,5 mm / 1.28 inch
Depth	93 mm / 3.661 inch

### Mechanical data

Design	horizontal type
Type of mounting	DIN-35 rail
Marking level	Center marking

### Material Data

Color	gray
Insulating material	Polyamide 66 (PA 66)
Fire load	0.335 MJ
Weight	21.4 g

### Commercial data



Product Group	1 (Rail Mounted Terminal Blocks)
Packaging type	BOX

Subject to changes. Please also observe the further product documentation!





Country of origin	DE
GTIN	4044918386098
Customs Tariff No.	85369010000

## Approvals / Certificates

### Country specific Approvals

Logo	Approval	Additional Approval Text	Certificate name
	CCA DEKRA Certification B.V.	EN 60947	2195540.01
	CCA DEKRA Certification B.V.	EN 60947	NTR NL-7522
	CSA DEKRA Certification B.V.	C22.2 No. 158	1505033

### Ship Approvals

Logo	Approval	Additional Approval Text	Certificate name
	ABS American Bureau of Shipping	EN 60947	20-HG1941090-PDA
	BV Bureau Veritas S.A.	EN 60947	07436/E0 BV
	DNV GL Det Norske Veritas, Germanischer Lloyd	-	TAE00001V2
	LR Lloyds Register	EN 60947	91/20112 (E9)

### UL-Approvals

Certificate



Subject to changes. Please also observe the further product documentation!

Logo	Approval	Additional Approval Text	name
	UL UL International Germany GmbH	UL 1059	20190731- E45172







## Counterpart

## Compatible products

### assembling

	<b>Item no.: 209-106</b> Mounting carrier; for isolated mounting on DIN 35 rails; gray	<a href="http://www.wago.com/209-106">www.wago.com/209-106</a>
	<b>Item no.: 709-153</b> Cover; Type 1; suitable for cover carrier, type 1; 1 m long; transparent	<a href="http://www.wago.com/709-153">www.wago.com/709-153</a>

### End plate

	<b>Item no.: 282-308</b> End and intermediate plate; 2.5 mm thick; gray	<a href="http://www.wago.com/282-308">www.wago.com/282-308</a>
	<b>Item no.: 282-309</b> Separator plate; 2 mm thick; oversized; gray	<a href="http://www.wago.com/282-309">www.wago.com/282-309</a>
	<b>Item no.: 282-339</b> End and intermediate plate; 2.5 mm thick; orange	<a href="http://www.wago.com/282-339">www.wago.com/282-339</a>
	<b>Item no.: 282-340</b> Separator plate; 2 mm thick; oversized; orange	<a href="http://www.wago.com/282-340">www.wago.com/282-340</a>
	<b>Item no.: 282-358</b> Step-down cover plate; 1 mm thick; in connection with 3-conductor 282-681 terminal blocks; gray	<a href="http://www.wago.com/282-358">www.wago.com/282-358</a>
	<b>Item no.: 282-368</b> Step-down cover plate; 1 mm thick; in connection with 3-conductor 282-681 terminal blocks; orange	<a href="http://www.wago.com/282-368">www.wago.com/282-368</a>

### Jumper

**Item no.: 210-103**

Subject to changes. Please also observe the further product documentation!

Wire commoning chain; insulated; 50 connections; black

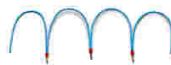
[www.wago.com/210-103](http://www.wago.com/210-103)**Item no.: 210-123**

Wire commoning chain; insulated; 50 connections

[www.wago.com/210-123](http://www.wago.com/210-123)**Item no.: 282-402**

Adjacent jumper; insulated; Nominal current 41 A

[www.wago.com/282-402](http://www.wago.com/282-402)**Item no.: 282-409**

Alternate jumper; insulated; Nominal current 41 A; gray

[www.wago.com/282-409](http://www.wago.com/282-409)**Item no.: 282-422**

Adjacent jumper; insulated; Nominal current 41 A; yellow-green

[www.wago.com/282-422](http://www.wago.com/282-422)**Item no.: 282-424**

Adjacent jumper; insulated; Nominal current 41 A; orange

[www.wago.com/282-424](http://www.wago.com/282-424)**Item no.: 284-413**Step-down jumper; insulated; from 10/6 mm<sup>2</sup> to 6/4 mm<sup>2</sup>; Nominal current 30 A; gray[www.wago.com/284-413](http://www.wago.com/284-413)**Item no.: 284-414**Step-down jumper; insulated; from 10/6 mm<sup>2</sup> to 4/2.5/1.5 mm<sup>2</sup>; Nominal current 15 A; gray[www.wago.com/284-414](http://www.wago.com/284-414)**Item no.: 709-110**

Wire commoning chain; insulated; 4 connections; 3 x 110 mm; black

[www.wago.com/709-110](http://www.wago.com/709-110)**Item no.: 709-111**

Wire commoning chain; insulated; 3 connections; 2 x 120 mm; black

[www.wago.com/709-111](http://www.wago.com/709-111)**Item no.: 709-112**

Wire commoning chain; insulated; 3 connections; 2 x 170 mm; black

[www.wago.com/709-112](http://www.wago.com/709-112)**Carrier rail****Item no.: 210-112**

Steel carrier rail; 35 x 7.5 mm; 1 mm thick; 2 m long; slotted; according to EN 60715; "Hole width 25 mm

[www.wago.com/210-112](http://www.wago.com/210-112)**Item no.: 210-113**

Steel carrier rail; 35 x 7.5 mm; 1 mm thick; 2 m long; unslotted; according to EN 60715

[www.wago.com/210-113](http://www.wago.com/210-113)**Item no.: 210-114**

Steel carrier rail; 35 x 15 mm; 1.5 mm thick; 2 m long; unslotted; similar to EN 60715

[www.wago.com/210-114](http://www.wago.com/210-114)**Item no.: 210-115**

Steel carrier rail; 35 x 7.5 mm; 1 mm thick; 2 m long; slotted; according to EN 60715; "Hole width 18 mm

[www.wago.com/210-115](http://www.wago.com/210-115)**Item no.: 210-118**

Steel carrier rail; 35 x 15 mm; 2.3 mm thick; 2 m long; unslotted; according to EN 60715

[www.wago.com/210-118](http://www.wago.com/210-118)**Item no.: 210-196**

Aluminum carrier rail; 35 x 8.2 mm; 1.6 mm thick; 2 m long; unslotted; similar to EN 60715; silver-colored

[www.wago.com/210-196](http://www.wago.com/210-196)

Subject to changes. Please also observe the further product documentation!

WAGO Kontakttechnik GmbH &amp; Co. KG

Hansastr. 27





32423 Minden

Phone: +49571 887-0 | Fax: +49571 887-169









Email: [info.de@wago.com](mailto:info.de@wago.com) | Web: [www.wago.com](http://www.wago.com)

Do you have any questions about our products?





We are always happy to take your call at +49 (571) 887-44222.

	<b>Item no.: 210-197</b> Steel carrier rail; 35 x 15 mm; 1.5 mm thick; 2 m long; slotted; similar to EN 60715	<a href="http://www.wago.com/210-197">www.wago.com/210-197</a>
	<b>Item no.: 210-198</b> Copper carrier rail; 35 x 15 mm; 2.3 mm thick; 2 m long; unslotted; according to EN 60715; copper-colored	<a href="http://www.wago.com/210-198">www.wago.com/210-198</a>
	<b>Item no.: 210-504</b> Steel carrier rail; 35 x 7.5 mm; 1 mm thick; 2 m long; slotted; galvanized; according to EN 60715	<a href="http://www.wago.com/210-504">www.wago.com/210-504</a>
	<b>Item no.: 210-505</b> Steel carrier rail; 35 x 7.5 mm; 1 mm thick; 2 m long; unslotted; galvanized; according to EN 60715	<a href="http://www.wago.com/210-505">www.wago.com/210-505</a>
	<b>Item no.: 210-506</b> Steel carrier rail; 35 x 15 mm; 1.5 mm thick; 2 m long; unslotted; galvanized; similar to EN 60715	<a href="http://www.wago.com/210-506">www.wago.com/210-506</a>
	<b>Item no.: 210-508</b> Steel carrier rail; 35 x 15 mm; 1.5 mm thick; 2 m long; slotted; galvanized; similar to EN 60715	<a href="http://www.wago.com/210-508">www.wago.com/210-508</a>
<b>tools</b>		
	<b>Item no.: 210-721</b> Operating tool; Blade: 5.5 x 0.8 mm; with a partially insulated shaft	<a href="http://www.wago.com/210-721">www.wago.com/210-721</a>
<b>General accessories</b>		
	<b>Item no.: 209-143</b> Group marker carrier; gray	<a href="http://www.wago.com/209-143">www.wago.com/209-143</a>
	<b>Item no.: 209-144</b> Group marker carrier; gray	<a href="http://www.wago.com/209-144">www.wago.com/209-144</a>
	<b>Item no.: 709-310</b> B-type test plug module; modular; suitable for all WAGO 282 Series rail-mounted terminal blocks with jumper slots; 6,00 mm <sup>2</sup> ; gray	<a href="http://www.wago.com/709-310">www.wago.com/709-310</a>
	<b>Item no.: 709-311</b> B-type spacer module; modular; e.g., for bridging commoned terminal blocks; gray	<a href="http://www.wago.com/709-311">www.wago.com/709-311</a>
<b>Marking accessories</b>		
	<b>Item no.: 2009-115</b> WMB-Inline; for Smart Printer; 1500 pieces on roll; stretchable 5 - 5.2 mm; plain; snap-on type; white	<a href="http://www.wago.com/2009-115">www.wago.com/2009-115</a>
	<b>Item no.: 2009-115/000-002</b> WMB-Inline; for Smart Printer; 1500 pieces on roll; stretchable 5 - 5.2 mm; plain; snap-on type; yellow	<a href="http://www.wago.com/2009-115/000-002">www.wago.com/2009-115/000-002</a>
	<b>Item no.: 2009-115/000-006</b> WMB-Inline; for Smart Printer; 1500 pieces on roll; stretchable 5 - 5.2 mm; plain; snap-on type; white	<a href="http://www.wago.com/2009-115/000-006">www.wago.com/2009-115/000-006</a>
	<b>Item no.: 2009-115/000-007</b> WMB-Inline; for Smart Printer; 1500 pieces on roll; stretchable 5 - 5.2 mm; plain; snap-on type; gray	<a href="http://www.wago.com/2009-115/000-007">www.wago.com/2009-115/000-007</a>

Subject to changes. Please also observe the further product documentation!

	<p><b>Item no.: 2009-115/000-012</b> WMB-Inline; for Smart Printer; 1500 pieces on roll; stretchable 5 - 5.2 mm; plain; snap-on type; white</p>	<p><a href="http://www.wago.com/2009-115/000-012">www.wago.com/2009-115/000-012</a></p>
	<p><b>Item no.: 2009-115/000-017</b> WMB-Inline; for Smart Printer; 1500 pieces on roll; stretchable 5 - 5.2 mm; plain; snap-on type; white</p>	<p><a href="http://www.wago.com/2009-115/000-017">www.wago.com/2009-115/000-017</a></p>
	<p><b>Item no.: 2009-115/000-023</b> WMB-Inline; for Smart Printer; 1500 pieces on roll; stretchable 5 - 5.2 mm; plain; snap-on type; green</p>	<p><a href="http://www.wago.com/2009-115/000-023">www.wago.com/2009-115/000-023</a></p>
	<p><b>Item no.: 2009-115/000-024</b> WMB-Inline; for Smart Printer; 1500 pieces on roll; stretchable 5 - 5.2 mm; plain; snap-on type; white</p>	<p><a href="http://www.wago.com/2009-115/000-024">www.wago.com/2009-115/000-024</a></p>
	<p><b>Item no.: 209-185</b> Adaptor; gray</p>	<p><a href="http://www.wago.com/209-185">www.wago.com/209-185</a></p>
	<p><b>Item no.: 210-612</b> Marking strips; for self-marking; plain; Self-adhesive; transparent</p>	<p><a href="http://www.wago.com/210-612">www.wago.com/210-612</a></p>
	<p><b>Item no.: 249-105</b> Group marker carrier; gray</p>	<p><a href="http://www.wago.com/249-105">www.wago.com/249-105</a></p>
	<p><b>Item no.: 793-501</b> WMB marking card; as card; not stretchable; plain; snap-on type; white</p>	<p><a href="http://www.wago.com/793-501">www.wago.com/793-501</a></p>
	<p><b>Item no.: 793-501/000-002</b> WMB marking card; as card; not stretchable; plain; snap-on type; yellow</p>	<p><a href="http://www.wago.com/793-501/000-002">www.wago.com/793-501/000-002</a></p>
	<p><b>Item no.: 793-501/000-005</b> WMB marking card; as card; not stretchable; plain; snap-on type; red</p>	<p><a href="http://www.wago.com/793-501/000-005">www.wago.com/793-501/000-005</a></p>
	<p><b>Item no.: 793-501/000-006</b> WMB marking card; as card; not stretchable; plain; snap-on type; blue</p>	<p><a href="http://www.wago.com/793-501/000-006">www.wago.com/793-501/000-006</a></p>
	<p><b>Item no.: 793-501/000-007</b> WMB marking card; as card; not stretchable; plain; snap-on type; gray</p>	<p><a href="http://www.wago.com/793-501/000-007">www.wago.com/793-501/000-007</a></p>
	<p><b>Item no.: 793-501/000-012</b> WMB marking card; as card; not stretchable; plain; snap-on type; orange</p>	<p><a href="http://www.wago.com/793-501/000-012">www.wago.com/793-501/000-012</a></p>
	<p><b>Item no.: 793-501/000-017</b> WMB marking card; as card; not stretchable; plain; snap-on type; light green</p>	<p><a href="http://www.wago.com/793-501/000-017">www.wago.com/793-501/000-017</a></p>

Subject to changes. Please also observe the further product documentation!

	<p><b>Item no.: 793-501/000-023</b> WMB marking card; as card; not stretchable; plain; snap-on type; green</p>	<p><a href="http://www.wago.com/793-501/000-023">www.wago.com/793-501/000-023</a></p>
	<p><b>Item no.: 793-501/000-024</b> WMB marking card; as card; not stretchable; plain; snap-on type; violet</p>	<p><a href="http://www.wago.com/793-501/000-024">www.wago.com/793-501/000-024</a></p>
	<p><b>Item no.: 793-5501</b> WMB marking card; as card; for terminal block width 5 - 17.5 mm; stretchable 5 - 5.2 mm; plain; snap-on type; white</p>	<p><a href="http://www.wago.com/793-5501">www.wago.com/793-5501</a></p>
	<p><b>Item no.: 793-5501/000-002</b> WMB marking card; as card; for terminal block width 5 - 17.5 mm; stretchable 5 - 5.2 mm; plain; snap-on type; yellow</p>	<p><a href="http://www.wago.com/793-5501/000-002">www.wago.com/793-5501/000-002</a></p>
	<p><b>Item no.: 793-5501/000-005</b> WMB marking card; as card; for terminal block width 5 - 17.5 mm; stretchable 5 - 5.2 mm; plain; snap-on type; red</p>	<p><a href="http://www.wago.com/793-5501/000-005">www.wago.com/793-5501/000-005</a></p>
	<p><b>Item no.: 793-5501/000-006</b> WMB marking card; as card; for terminal block width 5 - 17.5 mm; stretchable 5 - 5.2 mm; plain; snap-on type; blue</p>	<p><a href="http://www.wago.com/793-5501/000-006">www.wago.com/793-5501/000-006</a></p>
	<p><b>Item no.: 793-5501/000-007</b> WMB marking card; as card; for terminal block width 5 - 17.5 mm; stretchable 5 - 5.2 mm; plain; snap-on type; gray</p>	<p><a href="http://www.wago.com/793-5501/000-007">www.wago.com/793-5501/000-007</a></p>
	<p><b>Item no.: 793-5501/000-012</b> WMB marking card; as card; for terminal block width 5 - 17.5 mm; stretchable 5 - 5.2 mm; plain; snap-on type; orange</p>	<p><a href="http://www.wago.com/793-5501/000-012">www.wago.com/793-5501/000-012</a></p>
	<p><b>Item no.: 793-5501/000-014</b> WMB marking card; as card; for terminal block width 5 - 17.5 mm; stretchable 5 - 5.2 mm; plain; snap-on type; brown</p>	<p><a href="http://www.wago.com/793-5501/000-014">www.wago.com/793-5501/000-014</a></p>
	<p><b>Item no.: 793-5501/000-017</b> WMB marking card; as card; for terminal block width 5 - 17.5 mm; stretchable 5 - 5.2 mm; plain; snap-on type; green</p>	<p><a href="http://www.wago.com/793-5501/000-017">www.wago.com/793-5501/000-017</a></p>
	<p><b>Item no.: 793-5501/000-023</b> WMB marking card; as card; for terminal block width 5 - 17.5 mm; stretchable 5 - 5.2 mm; plain; snap-on type; light green</p>	<p><a href="http://www.wago.com/793-5501/000-023">www.wago.com/793-5501/000-023</a></p>
	<p><b>Item no.: 793-5501/000-024</b> WMB marking card; as card; for terminal block width 5 - 17.5 mm; stretchable 5 - 5.2 mm; plain; snap-on type; violet</p>	<p><a href="http://www.wago.com/793-5501/000-024">www.wago.com/793-5501/000-024</a></p>

**protection**

	<p><b>Item no.: 282-415</b> Protective warning marker; with high-voltage symbol, black; for 5 terminal blocks; yellow</p>	<p><a href="http://www.wago.com/282-415">www.wago.com/282-415</a></p>
------------------------------------------------------------------------------------	-------------------------------------------------------------------------------------------------------------------------------	-----------------------------------------------------------------------

**Test Accessories**

Subject to changes. Please also observe the further product documentation!





**Item no.: 209-170**

Test plug adapter; 8.3 mm wide; for 4 mm Ø test plugs; suitable for 1.5 mm<sup>2</sup> - 10 mm<sup>2</sup> tbs; gray

[www.wago.com/209-170](http://www.wago.com/209-170)

**ferrule**



**Item no.: 216-262**

Ferrule; Sleeve for 0.75 mm<sup>2</sup> / 18 AWG; insulated; electro-tin plated; electrolytic copper; gastight crimped; acc. to DIN 46228, Part 4/09.90; gray

[www.wago.com/216-262](http://www.wago.com/216-262)



**Item no.: 216-263**

Ferrule; Sleeve for 1 mm<sup>2</sup> / AWG 18; insulated; electro-tin plated; electrolytic copper; gastight crimped; acc. to DIN 46228, Part 4/09.90; red

[www.wago.com/216-263](http://www.wago.com/216-263)

**Item no.: 216-264**

Ferrule; Sleeve for 1.5 mm<sup>2</sup> / AWG 16; insulated; electro-tin plated; electrolytic copper; gastight crimped; acc. to DIN 46228, Part 4/09.90; black

[www.wago.com/216-264](http://www.wago.com/216-264)

**Item no.: 216-266**

Ferrule; Sleeve for 2.5 mm<sup>2</sup> / AWG 14; insulated; electro-tin plated; electrolytic copper; gastight crimped; acc. to DIN 46228, Part 4/09.90; blue

[www.wago.com/216-266](http://www.wago.com/216-266)



**Item no.: 216-267**

Ferrule; Sleeve for 4 mm<sup>2</sup> / AWG 12; insulated; electro-tin plated; electrolytic copper; gastight crimped; acc. to DIN 46228, Part 4/09.90; gray

[www.wago.com/216-267](http://www.wago.com/216-267)

**Downloads**

**Documentation**

**Additional Information**

Technical explanations	Apr 3, 2019	pdf 2.1 MB	Download
------------------------	-------------	---------------	----------

**CAD/CAE-Data**

**CAD data**

2D/3D Models 282-681	URL	Download
----------------------	-----	----------

**CAE data**

EPLAN Data Portal 282-681	URL	Download
---------------------------	-----	----------

WSCAD Universe 282-681	URL	Download
------------------------	-----	----------

**Installation Notes**

**Assembly**

Subject to changes. Please also observe the further product documentation!

WAGO Kontakttechnik GmbH & Co. KG  
 Hansastr. 27  
 32423 Minden  
 Phone: +49571 887-0 | Fax: +49571 887-169  
 Email: [info.de@wago.com](mailto:info.de@wago.com) | Web: [www.wago.com](http://www.wago.com)

Do you have any questions about our products?  
 We are always happy to take your call at +49 (571) 887-44222.

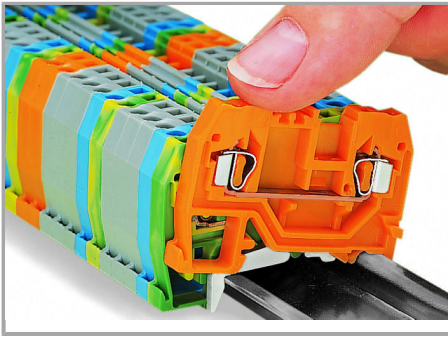

Snapping a terminal block onto the carrier rail.

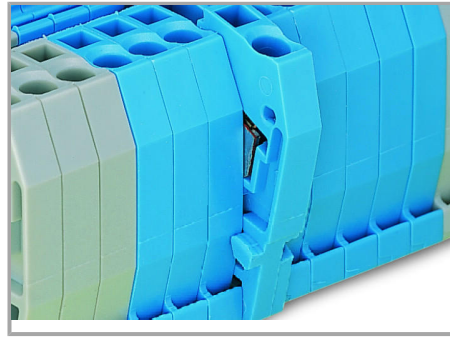

Quick assembly keys prevent reverse mounting.

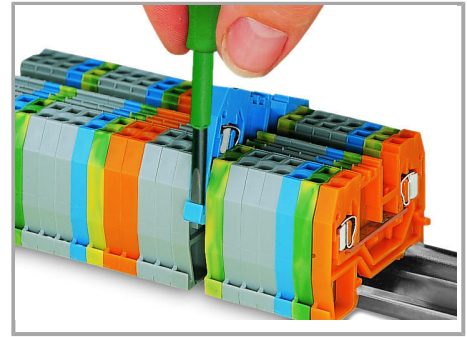

Removing a terminal block from the assembly.

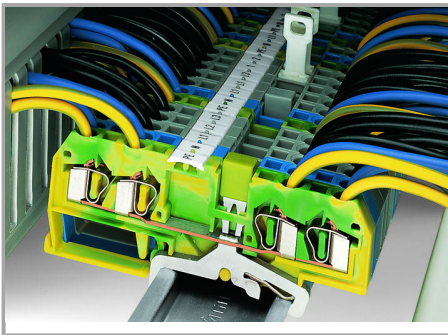

Steel carrier rails are not suited for PEN (ground and N-conductor) applications per EN 60947-7-2 (VDE 0611, Part 3).

#### Inserting a conductor

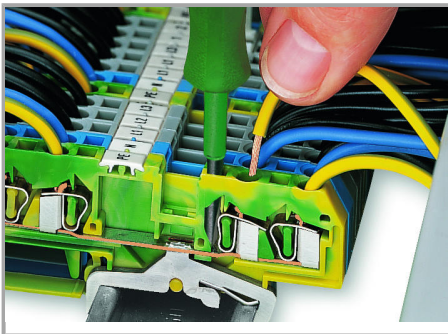

#### CAGE CLAMP® connection

Inserting a conductor.

Subject to changes. Please also observe the further product documentation!

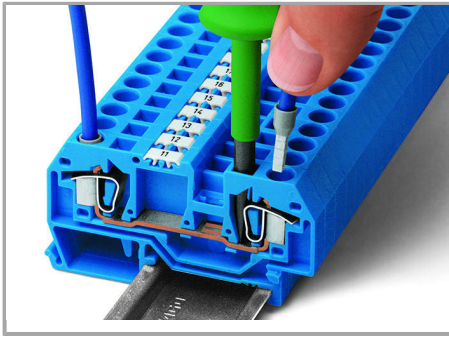

CAGE CLAMP® connection

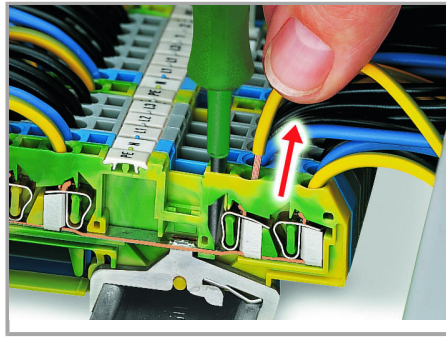

CAGE CLAMP® connection  
Removing a conductor.

Inserting a conductor.

With ferruled conductors, it is necessary to use a terminal block one size larger than the conductor's nominal cross-section.

#### Commoning

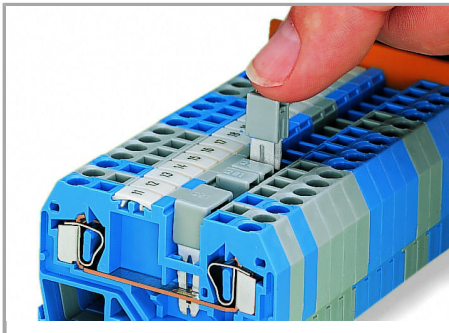

Commoning using an adjacent jumper (280-402).

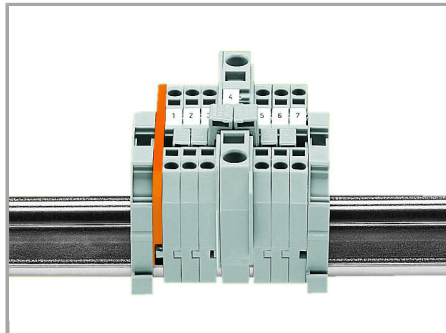

Commoning from 6 mm<sup>2</sup>/10 AWG (282 Series) to 1.5 mm<sup>2</sup>/16 AWG (279 Series) rail-mount terminal blocks via step-down jumpers.

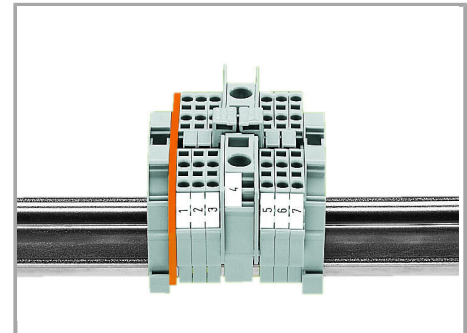

Commoning from 6 mm<sup>2</sup>/10 AWG (282 Series) to 1.5 mm<sup>2</sup>/16 AWG (279 Series) rail-mount terminal blocks via step-down jumpers.

Push jumper down until fully inserted.

Subject to changes. Please also observe the further product documentation!

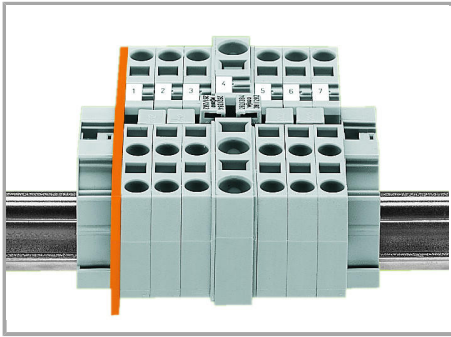

Commoning from 10 mm<sup>2</sup>/8 AWG (284 Series) to 6 mm<sup>2</sup>/10 AWG (282 Series) rail-mount terminal blocks via step-down jumpers.

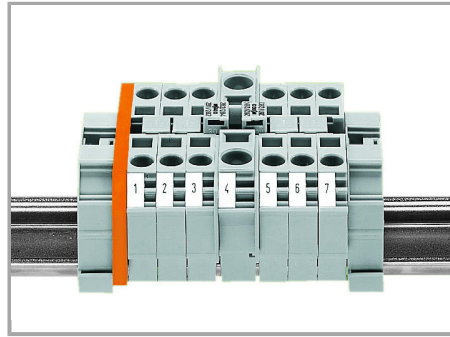

Commoning from 10 mm<sup>2</sup>/8 AWG (284 Series) to 6 mm<sup>2</sup>/10 AWG (282 Series) rail-mount terminal blocks via step-down jumpers.

### Testing

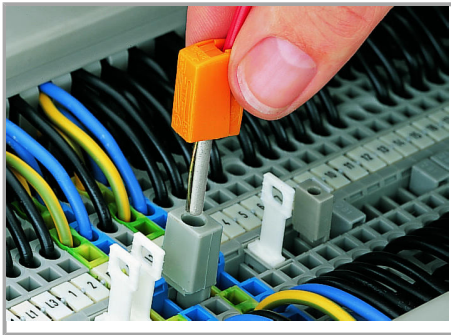

Testing with a test plug

(picture shows 209-170 Test Plug Adapter).

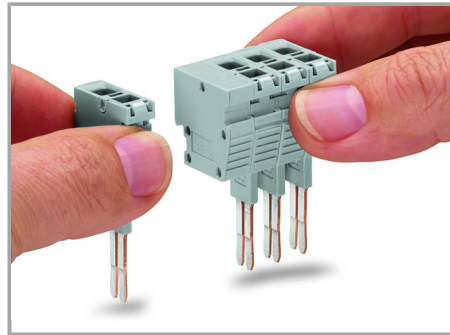

Snapping test plug and spacer modules together to assemble a multi-pole test plug module (max. 10 poles) for 8 mm terminal block width.

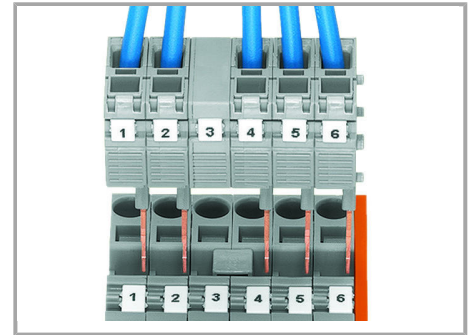

The test plug modules are directly plugged into the jumper contact slot of the current bar (picture shows 282 Series).

### Cover

Subject to changes. Please also observe the further product documentation!

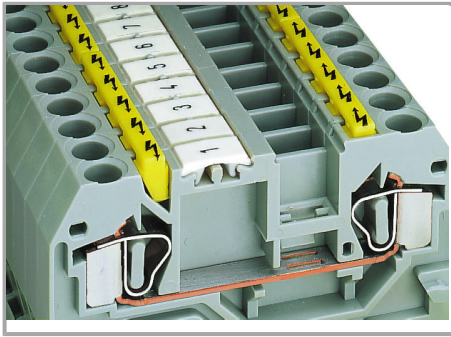

Protective warning markers inserted into the operating slots.

### Marking

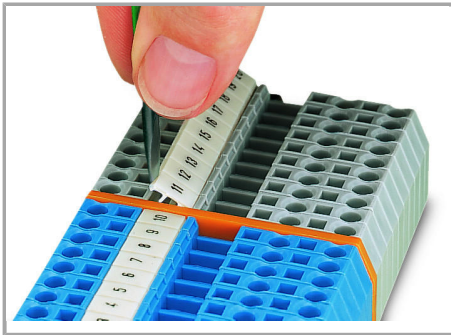

Marking via WMB Multi Marking System.

Subject to changes. Please also observe the further product documentation!