

Data sheet | Item number: 281-612/281-542

2-conductor fuse terminal block; with pivoting fuse holder; with blown fuse indication by LED; 30 - 65 V; for DIN-rail 35 x 15 and 35 x 7.5; 4 mm²; CAGE CLAMP®; 4,00 mm²; gray

www.wago.com/281-612/281-542



Item description

Note:

Terminating Aluminum Conductors

WAGO spring clamp terminal blocks are suitable for solid aluminum conductors up to 4 mm²/12 AWG if WAGO "Alu-Plus" Contact Paste is used for termination.

"Alu-Plus" Contact Paste Advantages:

- Automatically destroys the oxide film during clamping.
- Prevents fresh oxidation at the clamping point.

Subject to changes. Please also observe the further product documentation!

WAGO Kontakttechnik GmbH & Co. KG
Hansastr. 27
32423 Minden
Phone: +49571 887-0 | Fax: +49571 887-169
Email: info.de@wago.com | Web: www.wago.com

Do you have any questions about our products?
We are always happy to take your call at +49 (571) 887-44222.



- Prevents electrolytic corrosion between aluminum and copper conductors (in the same terminal block).
- Provides long-term protection against corrosion.

Using terminal blocks with CAGE CLAMP® Spring Pressure Connection Technology, **aluminum conductors must first be cleaned with a blade** and then immediately be inserted into the clamping units filled with "Alu-Plus" Contact Paste.

It is also possible to apply WAGO "Alu-Plus" **additionally** on the whole surface of the aluminum conductor before termination.

Please note that the nominal currents must be adapted to the reduced conductivity of the aluminum conductors::

2.5 mm² = 16 A

4 mm² = 22 A

Safety information 1:

Electrical ratings are given by the fuse and blown fuse indication.

Safety information 2:

Leakage current in case of a blown fuse: LED 6 mA

Data

Electrical data

Ratings per IEC/EN 60664-1

Ratings per	IEC/EN 60947-7-3
Rated voltage (III / 3)	800 V
Rated impulse voltage (III / 3)	8 kV
Rated current	10 A
Operation status indicator	30 ... 65 V
Legend (ratings)	(III / 3) ≙ Overvoltage category III / Pollution degree 3

Connection data

Connection technology	CAGE CLAMP®
Actuation type	Operating tool
Connectable conductor materials	Copper Aluminum
Solid conductor	0,08 ... 4 mm ² / 28 ... 12 AWG
Fine-stranded conductor	0,08 ... 4 mm ² / 28 ... 12 AWG
Strip length	9 ... 10 mm / 0.35 ... 0.39 inch
Total number of connection points	2
Total number of potentials	2
Number of levels	1
Type of wiring	Front-entry wiring

Subject to changes. Please also observe the further product documentation!

WAGO Kontakttechnik GmbH & Co. KG

Hansastr. 27

32423 Minden

Phone: +49571 887-0 | Fax: +49571 887-169

Email: info.de@wago.com | Web: www.wago.com

Do you have any questions about our products?

We are always happy to take your call at +49 (571) 887-44222.

Geometrical Data

Width	8 mm / 0.315 inch
Height from upper-edge of DIN-35 rail	60 mm / 2.362 inch
Depth	60 mm / 2.362 inch

Mechanical data

Design	angled
Type of mounting	DIN-35 rail
Marking level	Center marking

Material Data



Color	gray
Insulating material	Polyamide 66 (PA 66)
Fire load	0.338 MJ
Weight	17.8 g

Commercial data

Product Group	1 (Rail Mounted Terminal Blocks)
Packaging type	BOX
Country of origin	DE
GTIN	4045454317843
Customs Tariff No.	85369095990

Approvals / Certificates



Country specific Approvals

Logo	Approval	Additional Approval Text	Certificate name
	CSA DEKRA Certification B.V.	C22.2 No. 158	1505034
	KEMA/KEUR DEKRA Certification B.V.	EN 60947	2160584.31
	KEMA/KEUR DEKRA Certification B.V.	EN 60947	NTR NL- 7135

Subject to changes. Please also observe the further product documentation!

CCA

Ship Approvals

Logo	Approval	Additional Approval Text	Certificate name
	ABS American Bureau of Shipping	-	20- HG1941090- PDA
	DNV GL Det Norske Veritas, Germanischer Lloyd	-	TAE00001V2

UL-Approvals

Logo	Approval	Additional Approval Text	Certificate name
	UR Underwriters Laboratories Inc.	UL 1059	E45172

Counterpart

Compatible products

N-busbar

Item no.: 210-254

Interlocking link; mechanically locks multiple links; 1 m long; transparent

www.wago.com/210-254

Carrier rail

Item no.: 210-112

Subject to changes. Please also observe the further product documentation!

WAGO Kontakttechnik GmbH & Co. KG

Hansastr. 27







32423 Minden

Phone: +49571 887-0 | Fax: +49571 887-169

Email: info.de@wago.com | Web: www.wago.com

Do you have any questions about our products?

We are always happy to take your call at +49 (571) 887-44222.

	Steel carrier rail; 35 x 7.5 mm; 1 mm thick; 2 m long; slotted; according to EN 60715; "Hole width 25 mm	www.wago.com/210-112
	Item no.: 210-113 Steel carrier rail; 35 x 7.5 mm; 1 mm thick; 2 m long; unslotted; according to EN 60715	www.wago.com/210-113
	Item no.: 210-114 Steel carrier rail; 35 x 15 mm; 1.5 mm thick; 2 m long; unslotted; similar to EN 60715	www.wago.com/210-114
	Item no.: 210-115 Steel carrier rail; 35 x 7.5 mm; 1 mm thick; 2 m long; slotted; according to EN 60715; "Hole width 18 mm	www.wago.com/210-115
	Item no.: 210-118 Steel carrier rail; 35 x 15 mm; 2.3 mm thick; 2 m long; unslotted; according to EN 60715	www.wago.com/210-118
	Item no.: 210-196 Aluminum carrier rail; 35 x 8.2 mm; 1.6 mm thick; 2 m long; unslotted; similar to EN 60715; silver-colored	www.wago.com/210-196
	Item no.: 210-197 Steel carrier rail; 35 x 15 mm; 1.5 mm thick; 2 m long; slotted; similar to EN 60715	www.wago.com/210-197
	Item no.: 210-198 Copper carrier rail; 35 x 15 mm; 2.3 mm thick; 2 m long; unslotted; according to EN 60715; copper-colored	www.wago.com/210-198
	Item no.: 210-504 Steel carrier rail; 35 x 7.5 mm; 1 mm thick; 2 m long; slotted; galvanized; according to EN 60715	www.wago.com/210-504
	Item no.: 210-505 Steel carrier rail; 35 x 7.5 mm; 1 mm thick; 2 m long; unslotted; galvanized; according to EN 60715	www.wago.com/210-505
	Item no.: 210-506 Steel carrier rail; 35 x 15 mm; 1.5 mm thick; 2 m long; unslotted; galvanized; similar to EN 60715	www.wago.com/210-506
	Item no.: 210-508 Steel carrier rail; 35 x 15 mm; 1.5 mm thick; 2 m long; slotted; galvanized; similar to EN 60715	www.wago.com/210-508
General accessories		
	Item no.: 249-120 Group marker carrier; white	www.wago.com/249-120
	Item no.: 281-407 Test plug; 6 mm wide; Nominal current 24 A; for 0.08 mm ² - 2.5 mm ² ; 2,50 mm ² ; gray	www.wago.com/281-407
Jumper		
	Item no.: 210-103 Wire commoning chain; insulated; 50 connections; black	www.wago.com/210-103
	Item no.: 210-123 Wire commoning chain; insulated; 50 connections	www.wago.com/210-123
	Item no.: 249-123 Push-in type wire jumper; insulated; wire length 180 mm; Conductor cross section 0.75 mm ²	www.wago.com/249-123

Subject to changes. Please also observe the further product documentation!



Item no.: 249-125

Push-in type wire jumper; insulated; wire length 60 mm; Conductor cross section 0.75 mm²

www.wago.com/249-125

Item no.: 249-126

Push-in type wire jumper; insulated; wire length 110 mm; Conductor cross section 0.75 mm²

www.wago.com/249-126



Item no.: 249-127

Push-in type wire jumper; insulated; wire length 250 mm; Conductor cross section 0.75 mm²

www.wago.com/249-127

Item no.: 281-402

Adjacent jumper; insulated; IN = IN terminal block; gray

www.wago.com/281-402

Item no.: 709-110

Wire commoning chain; insulated; 4 connections; 3 x 110 mm; black

www.wago.com/709-110

Item no.: 709-111

Wire commoning chain; insulated; 3 connections; 2 x 120 mm; black

www.wago.com/709-111

Item no.: 709-112

Wire commoning chain; insulated; 3 connections; 2 x 170 mm; black

www.wago.com/709-112

Marking accessories



Item no.: 2009-115

WMB-Inline; for Smart Printer; 1500 pieces on roll; stretchable 5 - 5.2 mm; plain; snap-on type; white

www.wago.com/2009-115

Item no.: 2009-115/000-002

WMB-Inline; for Smart Printer; 1500 pieces on roll; stretchable 5 - 5.2 mm; plain; snap-on type; yellow

www.wago.com/2009-115/000-002



Item no.: 2009-115/000-006

WMB-Inline; for Smart Printer; 1500 pieces on roll; stretchable 5 - 5.2 mm; plain; snap-on type; white

www.wago.com/2009-115/000-006

Item no.: 2009-115/000-007

WMB-Inline; for Smart Printer; 1500 pieces on roll; stretchable 5 - 5.2 mm; plain; snap-on type; gray

www.wago.com/2009-115/000-007



Item no.: 2009-115/000-012

WMB-Inline; for Smart Printer; 1500 pieces on roll; stretchable 5 - 5.2 mm; plain; snap-on type; white

www.wago.com/2009-115/000-012

Item no.: 2009-115/000-017

WMB-Inline; for Smart Printer; 1500 pieces on roll; stretchable 5 - 5.2 mm; plain; snap-on type; white

www.wago.com/2009-115/000-017

Item no.: 2009-115/000-023

WMB-Inline; for Smart Printer; 1500 pieces on roll; stretchable 5 - 5.2 mm; plain; snap-on type; green

www.wago.com/2009-115/000-023

Item no.: 2009-115/000-024

WMB-Inline; for Smart Printer; 1500 pieces on roll; stretchable 5 - 5.2 mm; plain; snap-on type; white

www.wago.com/2009-115/000-024

Subject to changes. Please also observe the further product documentation!

WAGO Kontakttechnik GmbH & Co. KG

Hansastr. 27





32423 Minden

Phone: +49571 887-0 | Fax: +49571 887-169





Email: info.de@wago.com | Web: www.wago.com

Do you have any questions about our products?







We are always happy to take your call at +49 (571) 887-44222.

	<p>Item no.: 793-501 WMB marking card; as card; not stretchable; plain; snap-on type; white</p>	www.wago.com/793-501
	<p>Item no.: 793-501/000-002 WMB marking card; as card; not stretchable; plain; snap-on type; yellow</p>	www.wago.com/793-501/000-002
	<p>Item no.: 793-501/000-005 WMB marking card; as card; not stretchable; plain; snap-on type; red</p>	www.wago.com/793-501/000-005
	<p>Item no.: 793-501/000-006 WMB marking card; as card; not stretchable; plain; snap-on type; blue</p>	www.wago.com/793-501/000-006
	<p>Item no.: 793-501/000-007 WMB marking card; as card; not stretchable; plain; snap-on type; gray</p>	www.wago.com/793-501/000-007
	<p>Item no.: 793-501/000-012 WMB marking card; as card; not stretchable; plain; snap-on type; orange</p>	www.wago.com/793-501/000-012
	<p>Item no.: 793-501/000-017 WMB marking card; as card; not stretchable; plain; snap-on type; light green</p>	www.wago.com/793-501/000-017
	<p>Item no.: 793-501/000-023 WMB marking card; as card; not stretchable; plain; snap-on type; green</p>	www.wago.com/793-501/000-023
	<p>Item no.: 793-501/000-024 WMB marking card; as card; not stretchable; plain; snap-on type; violet</p>	www.wago.com/793-501/000-024
	<p>Item no.: 793-5501 WMB marking card; as card; for terminal block width 5 - 17.5 mm; stretchable 5 - 5.2 mm; plain; snap-on type; white</p>	www.wago.com/793-5501
	<p>Item no.: 793-5501/000-002 WMB marking card; as card; for terminal block width 5 - 17.5 mm; stretchable 5 - 5.2 mm; plain; snap-on type; yellow</p>	www.wago.com/793-5501/000-002
	<p>Item no.: 793-5501/000-005 WMB marking card; as card; for terminal block width 5 - 17.5 mm; stretchable 5 - 5.2 mm; plain; snap-on type; red</p>	www.wago.com/793-5501/000-005
	<p>Item no.: 793-5501/000-006 WMB marking card; as card; for terminal block width 5 - 17.5 mm; stretchable 5 - 5.2 mm; plain; snap-on type; blue</p>	www.wago.com/793-5501/000-006
	<p>Item no.: 793-5501/000-007 WMB marking card; as card; for terminal block width 5 - 17.5 mm; stretchable 5 - 5.2 mm; plain; snap-on type; gray</p>	www.wago.com/793-5501/000-007

Subject to changes. Please also observe the further product documentation!

	Item no.: 793-5501/000-012 WMB marking card; as card; for terminal block width 5 - 17.5 mm; stretchable 5 - 5.2 mm; plain; snap-on type; orange	www.wago.com/793-5501/000-012
	Item no.: 793-5501/000-017 WMB marking card; as card; for terminal block width 5 - 17.5 mm; stretchable 5 - 5.2 mm; plain; snap-on type; green	www.wago.com/793-5501/000-017
	Item no.: 793-5501/000-023 WMB marking card; as card; for terminal block width 5 - 17.5 mm; stretchable 5 - 5.2 mm; plain; snap-on type; light green	www.wago.com/793-5501/000-023
	Item no.: 793-5501/000-024 WMB marking card; as card; for terminal block width 5 - 17.5 mm; stretchable 5 - 5.2 mm; plain; snap-on type; violet	www.wago.com/793-5501/000-024
assembling		
	Item no.: 209-106 Mounting carrier; for isolated mounting on DIN 35 rails; gray	www.wago.com/209-106
	Item no.: 709-153 Cover; Type 1; suitable for cover carrier, type 1; 1 m long; transparent	www.wago.com/709-153
ferrule		
	Item no.: 216-106 Ferrule; Sleeve for 2.5 mm ² / AWG 14; uninsulated; electro-tin plated	www.wago.com/216-106
	Item no.: 216-201 Ferrule; Sleeve for 0.5 mm ² / 20 AWG; insulated; electro-tin plated; white	www.wago.com/216-201
	Item no.: 216-202 Ferrule; Sleeve for 0.75 mm ² / 18 AWG; insulated; electro-tin plated; gray	www.wago.com/216-202
	Item no.: 216-203 Ferrule; Sleeve for 1 mm ² / AWG 18; insulated; electro-tin plated; red	www.wago.com/216-203
	Item no.: 216-204 Ferrule; Sleeve for 1.5 mm ² / AWG 16; insulated; electro-tin plated; black	www.wago.com/216-204
	Item no.: 216-205 Ferrule; Sleeve for 2.08 mm ² / AWG 14; insulated; electro-tin plated; yellow	www.wago.com/216-205
	Item no.: 216-206 Ferrule; Sleeve for 2.5 mm ² / AWG 14; insulated; electro-tin plated; blue	www.wago.com/216-206
	Item no.: 216-241 Ferrule; Sleeve for 0.5 mm ² / 20 AWG; insulated; electro-tin plated; electrolytic copper; gastight crimped; acc. to DIN 46228, Part 4/09.90; white	www.wago.com/216-241
	Item no.: 216-242 Ferrule; Sleeve for 0.75 mm ² / 18 AWG; insulated; electro-tin plated; electrolytic copper; gastight crimped; acc. to DIN 46228, Part 4/09.90; gray	www.wago.com/216-242
	Item no.: 216-243	

Subject to changes. Please also observe the further product documentation!

	Ferrule; Sleeve for 1 mm ² / AWG 18; insulated; electro-tin plated; electrolytic copper; gastight crimped; acc. to DIN 46228, Part 4/09.90; red	www.wago.com/216-243
	Item no.: 216-244 Ferrule; Sleeve for 1.5 mm ² / AWG 16; insulated; electro-tin plated; electrolytic copper; gastight crimped; acc. to DIN 46228, Part 4/09.90; black	www.wago.com/216-244
	Item no.: 216-246 Ferrule; Sleeve for 2.5 mm ² / AWG 14; insulated; electro-tin plated; electrolytic copper; gastight crimped; acc. to DIN 46228, Part 4/09.90; blue	www.wago.com/216-246
	Item no.: 216-301 Ferrule; Sleeve for 0.25 mm ² / AWG 24; insulated; electro-tin plated; yellow	www.wago.com/216-301
	Item no.: 216-302 Ferrule; Sleeve for 0.34 mm ² / 22 AWG; insulated; electro-tin plated; green	www.wago.com/216-302
End plate		
	Item no.: 281-309 End and intermediate plate; 2.5 mm thick; orange	www.wago.com/281-309
	Item no.: 281-311 End and intermediate plate; 2.5 mm thick; gray	www.wago.com/281-311
Test Accessories		
	Item no.: 210-137 Test plug; 2.3 mm Ø; with 500 mm cable; yellow	www.wago.com/210-137
	Item no.: 280-404 Test plug adapter; 5 mm wide; for test plug 210-137 (2.3 mm Ø); suitable for 1.5 mm ² - 4 mm ² tbs; gray	www.wago.com/280-404
tools		
	Item no.: 210-657 Operating tool; Blade: 3.5 x 0.5 mm; with a partially insulated shaft; short	www.wago.com/210-657
	Item no.: 210-658 Operating tool; Blade: 3.5 x 0.5 mm; with a partially insulated shaft; angled; short	www.wago.com/210-658
	Item no.: 210-720 Operating tool; Blade: 3.5 x 0.5 mm; with a partially insulated shaft	www.wago.com/210-720

Downloads

Documentation

Additional Information

Technical explanations	Apr 3, 2019	pdf 2.1 MB	Download
------------------------	-------------	---------------	----------

Subject to changes. Please also observe the further product documentation!

CAD/CAE-Data

CAD data

2D/3D Models 281-612/281-542	URL	Download
------------------------------	---------------------	--------------------------

CAE data

EPLAN Data Portal 281-612/281-542	URL	Download
-----------------------------------	---------------------	--------------------------

WSCAD Universe 281-612/281-542	URL	Download
--------------------------------	---------------------	--------------------------

Installation Notes

Conductor termination

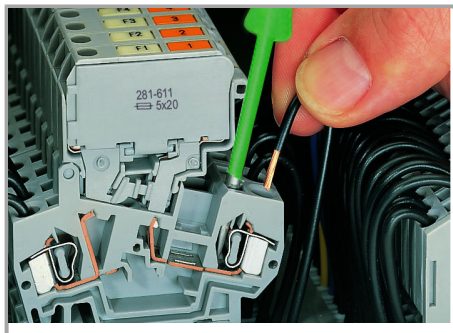

CAGE CLAMP® connection

Inserting a conductor via screwdriver.

With ferruled conductors, it is necessary to use a terminal block one size smaller than the conductor's nominal cross section.

Commoning

Subject to changes. Please also observe the further product documentation!

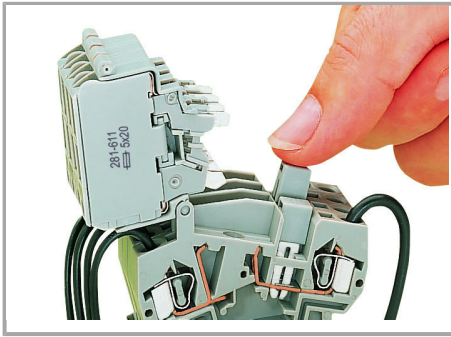

Commoning:

Distributing current to several fuse-protected circuits via insulated push-in type jumpers.

Testing

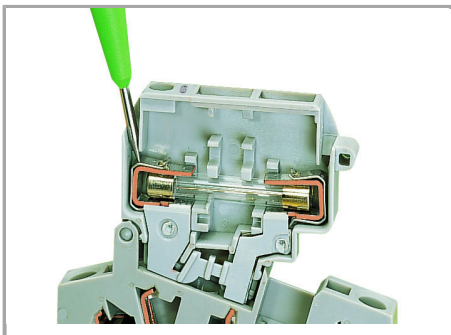

Voltage test, either at input or output with fuse holder in closed position (live)

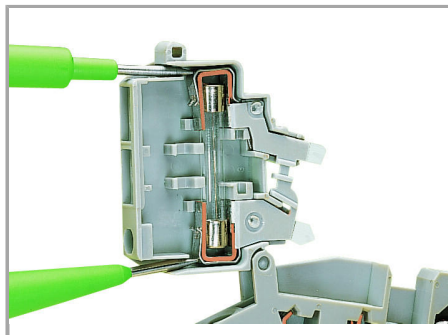

Through test with fuse holder in open position (no voltage)

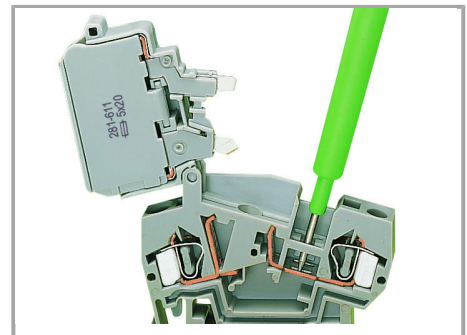

Voltage test at input in the test slot of the current bar

Subject to changes. Please also observe the further product documentation!

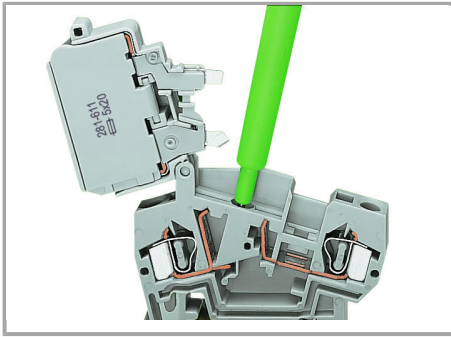

Testing voltage at the output via separate test slot.

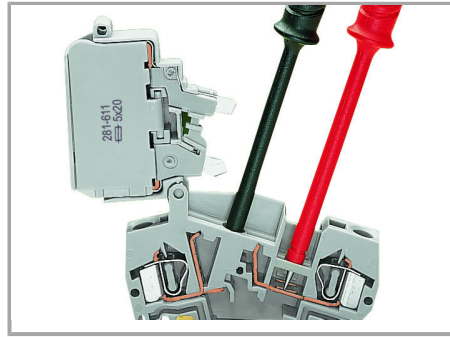

Measuring current between jumper slot and separate test slot.

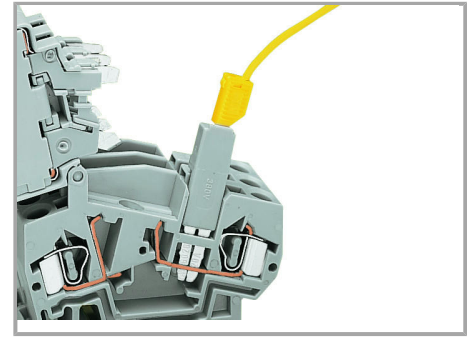

Testing voltage (input side) via test plug adapter (280-404, shown) or test plug (281-407).

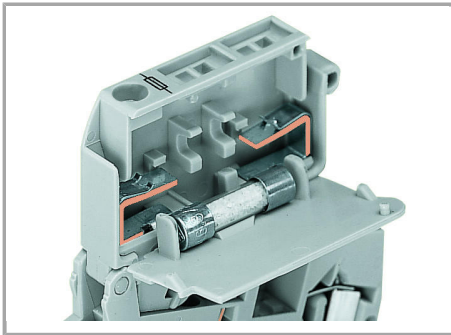

5 x 20 mm, 5 x 25 mm and 1/4" x 1" fuse holders are fitted with stops on the inside of the cover.

Safety

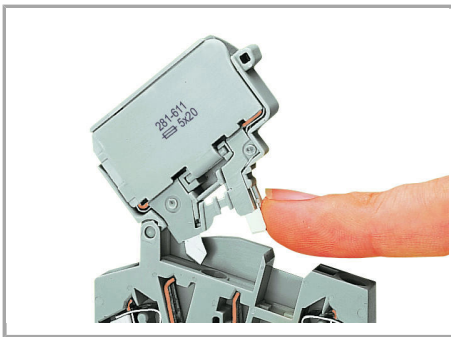

Touch-proof protection in all positions of the fuse holder

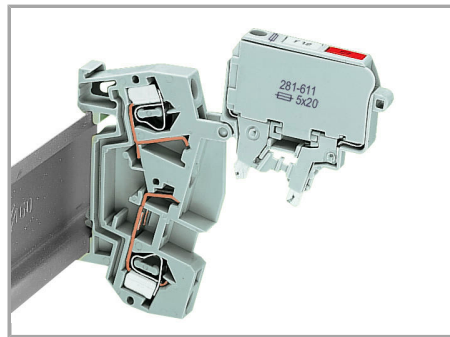

Fuse holder will remain safely locked open in vertical assemblies.

Locking lever

Subject to changes. Please also observe the further product documentation!

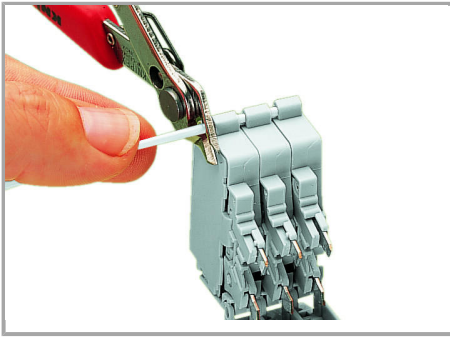

Ganging several fuse holders with an interlocking link (example shows 8 mm wide terminal blocks).

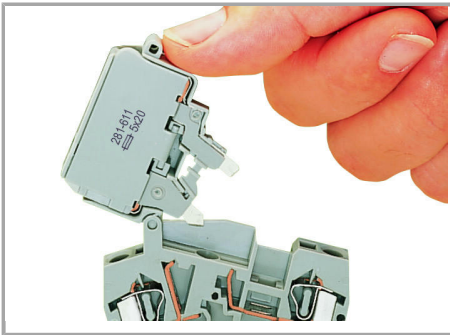

Fuse replacement:

Before replacing a fuse, pivot the fuse holder into the locked open position.

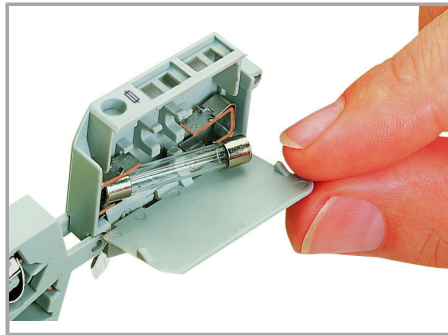

Fuse replacement:

One end of the fuse is automatically ejected from the holder when opening the cover.

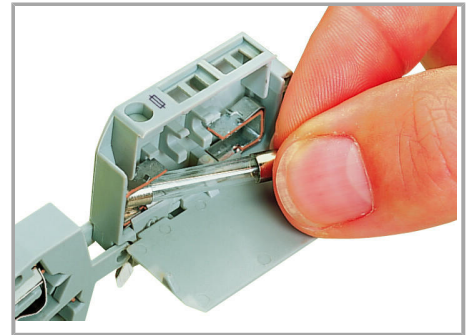

Fuse replacement:

Easily removing a fuse by hand.

Subject to changes. Please also observe the further product documentation!

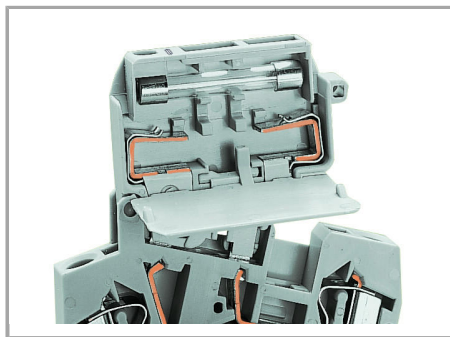
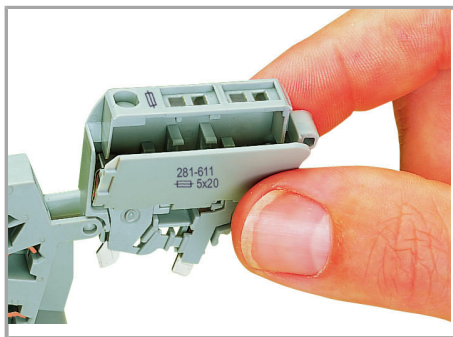

Fuse replacement:

Storing a spare fuse (fuse holder without blown fuse indication).

Insert a new fuse and snap the cover closed.

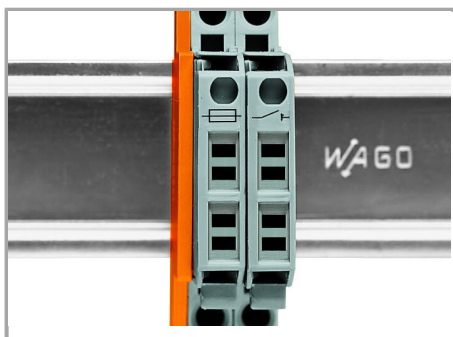

Fused disconnect or disconnect terminal blocks with a width of 8 mm can be assembled adjacently. At the end of an assembly or if there is **no** adjacent fused disconnect or disconnect terminal block, an end or intermediate plate must be used.

Marking

Subject to changes. Please also observe the further product documentation!

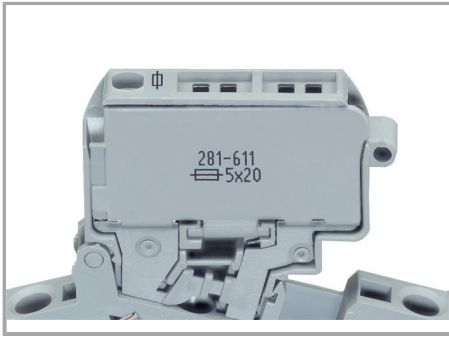

Fuse holders are printed with correct fuse size.

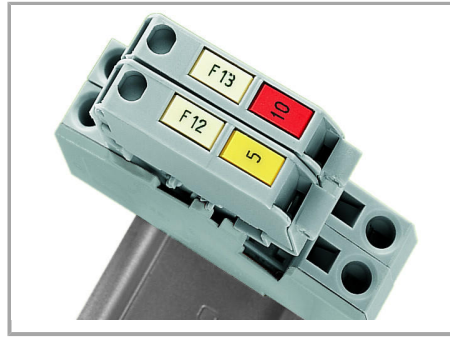

Each fuse holder features two marker slots for custom WMB Multi markers (example shows 8 mm wide terminal blocks).

Subject to changes. Please also observe the further product documentation!