

## Data sheet | Item number: 281-612/281-418

2-conductor fuse terminal block; with pivoting fuse holder; with blown fuse indication by neon lamp; 120 V; for DIN-rail 35 x 15 and 35 x 7.5; 4 mm<sup>2</sup>; CAGE CLAMP®; 4,00 mm<sup>2</sup>; gray

[www.wago.com/281-612/281-418](http://www.wago.com/281-612/281-418)

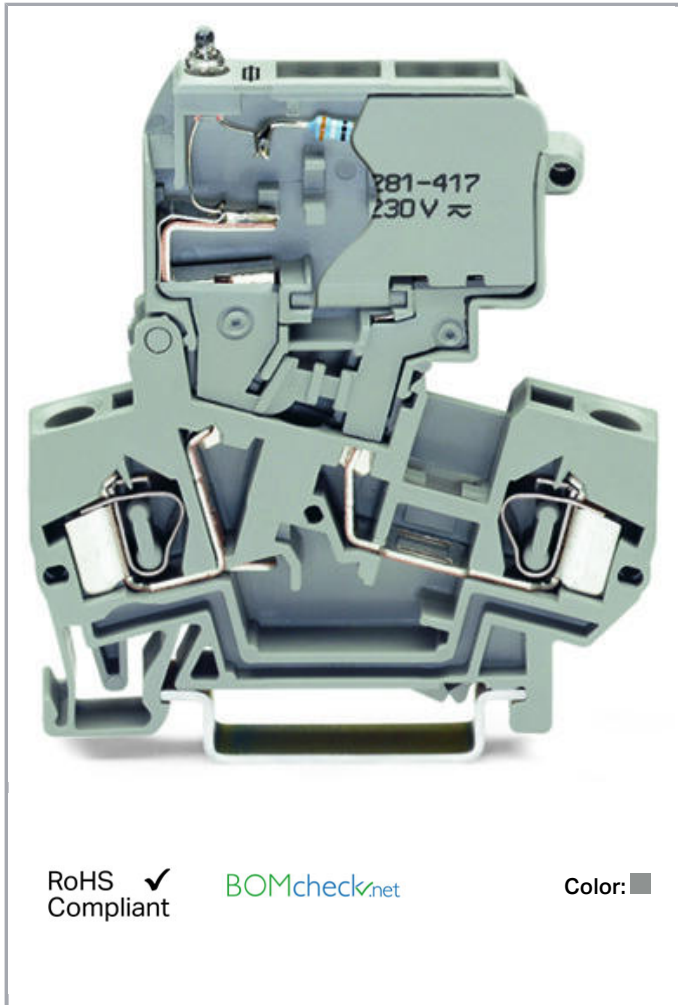

### Item description

#### Note:

#### Terminating Aluminum Conductors

WAGO spring clamp terminal blocks are suitable for solid aluminum conductors up to 4 mm<sup>2</sup>/12 AWG if WAGO "Alu-Plus" Contact Paste is used for termination.

"Alu-Plus" Contact Paste Advantages:

- Automatically destroys the oxide film during clamping.
- Prevents fresh oxidation at the clamping point.

—  
Subject to changes. Please also observe the further product documentation!

WAGO Kontakttechnik GmbH & Co. KG  
Hansastr. 27  
32423 Minden  
Phone: +49571 887-0 | Fax: +49571 887-169  
Email: [info.de@wago.com](mailto:info.de@wago.com) | Web: [www.wago.com](http://www.wago.com)

Do you have any questions about our products?  
We are always happy to take your call at +49 (571) 887-44222.



- Prevents electrolytic corrosion between aluminum and copper conductors (in the same terminal block).
- Provides long-term protection against corrosion.

Using terminal blocks with CAGE CLAMP® Spring Pressure Connection Technology, **aluminum conductors must first be cleaned with a blade** and then immediately be inserted into the clamping units filled with "Alu-Plus" Contact Paste.

It is also possible to apply WAGO "Alu-Plus" **additionally** on the whole surface of the aluminum conductor before termination.

Please note that the nominal currents must be adapted to the reduced conductivity of the aluminum conductors::

2.5 mm<sup>2</sup> = 16 A

4 mm<sup>2</sup> = 22 A

#### Safety information 1:

Electrical ratings are given by the fuse and blown fuse indication.

#### Safety information 2:

Leakage current in case of a blown fuse: Neon lamp < 0.4 mA

## Data

### Electrical data

#### Ratings per IEC/EN 60664-1

|                                 |                                                           |
|---------------------------------|-----------------------------------------------------------|
| Ratings per                     | IEC/EN 60947-7-3                                          |
| Rated voltage (III / 3)         | 800 V                                                     |
| Rated impulse voltage (III / 3) | 8 kV                                                      |
| Rated current                   | 10 A                                                      |
| Operation status indicator      | 120 V                                                     |
| Legend (ratings)                | (III / 3) ≙ Overvoltage category III / Pollution degree 3 |

### Connection data

|                                   |                                            |
|-----------------------------------|--------------------------------------------|
| Connection technology             | CAGE CLAMP®                                |
| Actuation type                    | Operating tool                             |
| Connectable conductor materials   | Copper<br>Aluminum                         |
| Solid conductor                   | 0,08 ... 4 mm <sup>2</sup> / 28 ... 12 AWG |
| Fine-stranded conductor           | 0,08 ... 4 mm <sup>2</sup> / 28 ... 12 AWG |
| Strip length                      | 9 ... 10 mm / 0.35 ... 0.39 inch           |
| Total number of connection points | 2                                          |
| Total number of potentials        | 2                                          |
| Number of levels                  | 1                                          |
| Type of wiring                    | Front-entry wiring                         |

Subject to changes. Please also observe the further product documentation!

WAGO Kontakttechnik GmbH & Co. KG

Hansastr. 27

32423 Minden

Phone: +49571 887-0 | Fax: +49571 887-169

Email: [info.de@wago.com](mailto:info.de@wago.com) | Web: [www.wago.com](http://www.wago.com)

Do you have any questions about our products?

We are always happy to take your call at +49 (571) 887-44222.

## Geometrical Data

|                                       |                    |
|---------------------------------------|--------------------|
| Width                                 | 8 mm / 0.315 inch  |
| Height from upper-edge of DIN-35 rail | 60 mm / 2.362 inch |
| Depth                                 | 60 mm / 2.362 inch |

## Mechanical data

|                  |                |
|------------------|----------------|
| Design           | angled         |
| Type of mounting | DIN-35 rail    |
| Marking level    | Center marking |

## Material Data



|                     |                      |
|---------------------|----------------------|
| Color               | gray                 |
| Insulating material | Polyamide 66 (PA 66) |
| Fire load           | 0.333 MJ             |
| Weight              | 17.5 g               |

## Commercial data

|                    |                                  |
|--------------------|----------------------------------|
| Product Group      | 1 (Rail Mounted Terminal Blocks) |
| Packaging type     | BOX                              |
| Country of origin  | DE                               |
| GTIN               | 4045454197018                    |
| Customs Tariff No. | 85369095990                      |

## Approvals / Certificates



### Country specific Approvals

| Logo                                                                               | Approval                              | Additional Approval Text | Certificate name |
|------------------------------------------------------------------------------------|---------------------------------------|--------------------------|------------------|
|  | CSA<br>DEKRA Certification B.V.       | C22.2 No. 158            | 1505034          |
|  | KEMA/KEUR<br>DEKRA Certification B.V. | EN 60947                 | NTR NL-7135      |
|                                                                                    | KEMA/KEUR<br>DEKRA Certification B.V. | EN 60947                 | 2160584.31       |

Subject to changes. Please also observe the further product documentation!



### Ship Approvals

| Logo                                                                             | Approval                                                | Additional Approval Text | Certificate name         |
|----------------------------------------------------------------------------------|---------------------------------------------------------|--------------------------|--------------------------|
|  | <b>ABS</b><br>American Bureau of Shipping               | -                        | 20-<br>HG1941090-<br>PDA |
|  | <b>DNV GL</b><br>Det Norske Veritas, Germanischer Lloyd | -                        | TAE00001V2               |

### UL-Approvals

| Logo                                                                              | Approval                                    | Additional Approval Text | Certificate name |
|-----------------------------------------------------------------------------------|---------------------------------------------|--------------------------|------------------|
|  | <b>UR</b><br>Underwriters Laboratories Inc. | UL 1059                  | E45172           |

### Counterpart

### Compatible products

### Carrier rail

**Item no.: 210-112**

Steel carrier rail; 35 x 7.5 mm; 1 mm thick; 2 m long; slotted; according to EN 60715; "Hole width 25 mm [www.wago.com/210-112](http://www.wago.com/210-112)

Subject to changes. Please also observe the further product documentation!

WAGO Kontakttechnik GmbH & Co. KG

Hansastr. 27







32423 Minden

Phone: +49571 887-0 | Fax: +49571 887-169





Email: [info.de@wago.com](mailto:info.de@wago.com) | Web: [www.wago.com](http://www.wago.com)

Do you have any questions about our products?



We are always happy to take your call at +49 (571) 887-44222.

|                                                                                    |                                                                                                                                        |                                                                |
|------------------------------------------------------------------------------------|----------------------------------------------------------------------------------------------------------------------------------------|----------------------------------------------------------------|
|                                                                                    | <b>Item no.: 210-113</b><br>Steel carrier rail; 35 x 7.5 mm; 1 mm thick; 2 m long; unslotted; according to EN 60715                    | <a href="http://www.wago.com/210-113">www.wago.com/210-113</a> |
|                                                                                    | <b>Item no.: 210-114</b><br>Steel carrier rail; 35 x 15 mm; 1.5 mm thick; 2 m long; unslotted; similar to EN 60715                     | <a href="http://www.wago.com/210-114">www.wago.com/210-114</a> |
|                                                                                    | <b>Item no.: 210-115</b><br>Steel carrier rail; 35 x 7.5 mm; 1 mm thick; 2 m long; slotted; according to EN 60715; "Hole width 18 mm   | <a href="http://www.wago.com/210-115">www.wago.com/210-115</a> |
|    | <b>Item no.: 210-118</b><br>Steel carrier rail; 35 x 15 mm; 2.3 mm thick; 2 m long; unslotted; according to EN 60715                   | <a href="http://www.wago.com/210-118">www.wago.com/210-118</a> |
|    | <b>Item no.: 210-196</b><br>Aluminum carrier rail; 35 x 8.2 mm; 1.6 mm thick; 2 m long; unslotted; similar to EN 60715; silver-colored | <a href="http://www.wago.com/210-196">www.wago.com/210-196</a> |
|    | <b>Item no.: 210-197</b><br>Steel carrier rail; 35 x 15 mm; 1.5 mm thick; 2 m long; slotted; similar to EN 60715                       | <a href="http://www.wago.com/210-197">www.wago.com/210-197</a> |
|    | <b>Item no.: 210-198</b><br>Copper carrier rail; 35 x 15 mm; 2.3 mm thick; 2 m long; unslotted; according to EN 60715; copper-colored  | <a href="http://www.wago.com/210-198">www.wago.com/210-198</a> |
|                                                                                    | <b>Item no.: 210-504</b><br>Steel carrier rail; 35 x 7.5 mm; 1 mm thick; 2 m long; slotted; galvanized; according to EN 60715          | <a href="http://www.wago.com/210-504">www.wago.com/210-504</a> |
|                                                                                    | <b>Item no.: 210-505</b><br>Steel carrier rail; 35 x 7.5 mm; 1 mm thick; 2 m long; unslotted; galvanized; according to EN 60715        | <a href="http://www.wago.com/210-505">www.wago.com/210-505</a> |
|                                                                                    | <b>Item no.: 210-506</b><br>Steel carrier rail; 35 x 15 mm; 1.5 mm thick; 2 m long; unslotted; galvanized; similar to EN 60715         | <a href="http://www.wago.com/210-506">www.wago.com/210-506</a> |
|  | <b>Item no.: 210-508</b><br>Steel carrier rail; 35 x 15 mm; 1.5 mm thick; 2 m long; slotted; galvanized; similar to EN 60715           | <a href="http://www.wago.com/210-508">www.wago.com/210-508</a> |
| <b>ferrule</b>                                                                     |                                                                                                                                        |                                                                |
|                                                                                    | <b>Item no.: 216-106</b><br>Ferrule; Sleeve for 2.5 mm <sup>2</sup> / AWG 14; uninsulated; electro-tin plated                          | <a href="http://www.wago.com/216-106">www.wago.com/216-106</a> |
|                                                                                    | <b>Item no.: 216-201</b><br>Ferrule; Sleeve for 0.5 mm <sup>2</sup> / 20 AWG; insulated; electro-tin plated; white                     | <a href="http://www.wago.com/216-201">www.wago.com/216-201</a> |
|                                                                                    | <b>Item no.: 216-202</b><br>Ferrule; Sleeve for 0.75 mm <sup>2</sup> / 18 AWG; insulated; electro-tin plated; gray                     | <a href="http://www.wago.com/216-202">www.wago.com/216-202</a> |
|                                                                                    | <b>Item no.: 216-203</b><br>Ferrule; Sleeve for 1 mm <sup>2</sup> / AWG 18; insulated; electro-tin plated; red                         | <a href="http://www.wago.com/216-203">www.wago.com/216-203</a> |
|   | <b>Item no.: 216-204</b><br>Ferrule; Sleeve for 1.5 mm <sup>2</sup> / AWG 16; insulated; electro-tin plated; black                     | <a href="http://www.wago.com/216-204">www.wago.com/216-204</a> |
|   | <b>Item no.: 216-205</b><br>Ferrule; Sleeve for 2.08 mm <sup>2</sup> / AWG 14; insulated; electro-tin plated; yellow                   | <a href="http://www.wago.com/216-205">www.wago.com/216-205</a> |





Subject to changes. Please also observe the further product documentation!

|                                                                                  |                                                                                                                                                                                            |                                                                |
|----------------------------------------------------------------------------------|--------------------------------------------------------------------------------------------------------------------------------------------------------------------------------------------|----------------------------------------------------------------|
|  | <b>Item no.: 216-206</b><br>Ferrule; Sleeve for 2.5 mm <sup>2</sup> / AWG 14; insulated; electro-tin plated; blue                                                                          | <a href="http://www.wago.com/216-206">www.wago.com/216-206</a> |
|                                                                                  | <b>Item no.: 216-241</b><br>Ferrule; Sleeve for 0.5 mm <sup>2</sup> / 20 AWG; insulated; electro-tin plated; electrolytic copper; gastight crimped; acc. to DIN 46228, Part 4/09.90; white | <a href="http://www.wago.com/216-241">www.wago.com/216-241</a> |
|                                                                                  | <b>Item no.: 216-242</b><br>Ferrule; Sleeve for 0.75 mm <sup>2</sup> / 18 AWG; insulated; electro-tin plated; electrolytic copper; gastight crimped; acc. to DIN 46228, Part 4/09.90; gray | <a href="http://www.wago.com/216-242">www.wago.com/216-242</a> |
|  | <b>Item no.: 216-243</b><br>Ferrule; Sleeve for 1 mm <sup>2</sup> / AWG 18; insulated; electro-tin plated; electrolytic copper; gastight crimped; acc. to DIN 46228, Part 4/09.90; red     | <a href="http://www.wago.com/216-243">www.wago.com/216-243</a> |
|  | <b>Item no.: 216-244</b><br>Ferrule; Sleeve for 1.5 mm <sup>2</sup> / AWG 16; insulated; electro-tin plated; electrolytic copper; gastight crimped; acc. to DIN 46228, Part 4/09.90; black | <a href="http://www.wago.com/216-244">www.wago.com/216-244</a> |
|  | <b>Item no.: 216-246</b><br>Ferrule; Sleeve for 2.5 mm <sup>2</sup> / AWG 14; insulated; electro-tin plated; electrolytic copper; gastight crimped; acc. to DIN 46228, Part 4/09.90; blue  | <a href="http://www.wago.com/216-246">www.wago.com/216-246</a> |
|                                                                                  | <b>Item no.: 216-301</b><br>Ferrule; Sleeve for 0.25 mm <sup>2</sup> / AWG 24; insulated; electro-tin plated; yellow                                                                       | <a href="http://www.wago.com/216-301">www.wago.com/216-301</a> |
|  | <b>Item no.: 216-302</b><br>Ferrule; Sleeve for 0.34 mm <sup>2</sup> / 22 AWG; insulated; electro-tin plated; green                                                                        | <a href="http://www.wago.com/216-302">www.wago.com/216-302</a> |

**Marking accessories**

|                                                                                    |                                                                                                                                              |                                                                                  |
|------------------------------------------------------------------------------------|----------------------------------------------------------------------------------------------------------------------------------------------|----------------------------------------------------------------------------------|
|  | <b>Item no.: 2009-115</b><br>WMB-Inline; for Smart Printer; 1500 pieces on roll; stretchable 5 - 5.2 mm; plain; snap-on type; white          | <a href="http://www.wago.com/2009-115">www.wago.com/2009-115</a>                 |
|                                                                                    | <b>Item no.: 2009-115/000-002</b><br>WMB-Inline; for Smart Printer; 1500 pieces on roll; stretchable 5 - 5.2 mm; plain; snap-on type; yellow | <a href="http://www.wago.com/2009-115/000-002">www.wago.com/2009-115/000-002</a> |
|  | <b>Item no.: 2009-115/000-006</b><br>WMB-Inline; for Smart Printer; 1500 pieces on roll; stretchable 5 - 5.2 mm; plain; snap-on type; white  | <a href="http://www.wago.com/2009-115/000-006">www.wago.com/2009-115/000-006</a> |
|                                                                                    | <b>Item no.: 2009-115/000-007</b><br>WMB-Inline; for Smart Printer; 1500 pieces on roll; stretchable 5 - 5.2 mm; plain; snap-on type; gray   | <a href="http://www.wago.com/2009-115/000-007">www.wago.com/2009-115/000-007</a> |
|  | <b>Item no.: 2009-115/000-012</b><br>WMB-Inline; for Smart Printer; 1500 pieces on roll; stretchable 5 - 5.2 mm; plain; snap-on type; white  | <a href="http://www.wago.com/2009-115/000-012">www.wago.com/2009-115/000-012</a> |
|                                                                                    | <b>Item no.: 2009-115/000-017</b><br>WMB-Inline; for Smart Printer; 1500 pieces on roll; stretchable 5 - 5.2 mm; plain; snap-on type; white  | <a href="http://www.wago.com/2009-115/000-017">www.wago.com/2009-115/000-017</a> |
|                                                                                    | <b>Item no.: 2009-115/000-023</b><br>WMB-Inline; for Smart Printer; 1500 pieces on roll; stretchable 5 - 5.2 mm; plain; snap-on type; green  | <a href="http://www.wago.com/2009-115/000-023">www.wago.com/2009-115/000-023</a> |



Subject to changes. Please also observe the further product documentation!

|                                                                                    |                                                                                                                                                                   |                                                                                         |
|------------------------------------------------------------------------------------|-------------------------------------------------------------------------------------------------------------------------------------------------------------------|-----------------------------------------------------------------------------------------|
|                                                                                    | <p><b>Item no.: 2009-115/000-024</b><br/>WMB-Inline; for Smart Printer; 1500 pieces on roll; stretchable 5 - 5.2 mm; plain; snap-on type; white</p>               | <p><a href="http://www.wago.com/2009-115/000-024">www.wago.com/2009-115/000-024</a></p> |
|    | <p><b>Item no.: 793-501</b><br/>WMB marking card; as card; not stretchable; plain; snap-on type; white</p>                                                        | <p><a href="http://www.wago.com/793-501">www.wago.com/793-501</a></p>                   |
|                                                                                    | <p><b>Item no.: 793-501/000-002</b><br/>WMB marking card; as card; not stretchable; plain; snap-on type; yellow</p>                                               | <p><a href="http://www.wago.com/793-501/000-002">www.wago.com/793-501/000-002</a></p>   |
|                                                                                    | <p><b>Item no.: 793-501/000-005</b><br/>WMB marking card; as card; not stretchable; plain; snap-on type; red</p>                                                  | <p><a href="http://www.wago.com/793-501/000-005">www.wago.com/793-501/000-005</a></p>   |
|                                                                                    | <p><b>Item no.: 793-501/000-006</b><br/>WMB marking card; as card; not stretchable; plain; snap-on type; blue</p>                                                 | <p><a href="http://www.wago.com/793-501/000-006">www.wago.com/793-501/000-006</a></p>   |
|    | <p><b>Item no.: 793-501/000-007</b><br/>WMB marking card; as card; not stretchable; plain; snap-on type; gray</p>                                                 | <p><a href="http://www.wago.com/793-501/000-007">www.wago.com/793-501/000-007</a></p>   |
|                                                                                    | <p><b>Item no.: 793-501/000-012</b><br/>WMB marking card; as card; not stretchable; plain; snap-on type; orange</p>                                               | <p><a href="http://www.wago.com/793-501/000-012">www.wago.com/793-501/000-012</a></p>   |
|                                                                                    | <p><b>Item no.: 793-501/000-017</b><br/>WMB marking card; as card; not stretchable; plain; snap-on type; light green</p>                                          | <p><a href="http://www.wago.com/793-501/000-017">www.wago.com/793-501/000-017</a></p>   |
|                                                                                    | <p><b>Item no.: 793-501/000-023</b><br/>WMB marking card; as card; not stretchable; plain; snap-on type; green</p>                                                | <p><a href="http://www.wago.com/793-501/000-023">www.wago.com/793-501/000-023</a></p>   |
|  | <p><b>Item no.: 793-501/000-024</b><br/>WMB marking card; as card; not stretchable; plain; snap-on type; violet</p>                                               | <p><a href="http://www.wago.com/793-501/000-024">www.wago.com/793-501/000-024</a></p>   |
|  | <p><b>Item no.: 793-5501</b><br/>WMB marking card; as card; for terminal block width 5 - 17.5 mm; stretchable 5 - 5.2 mm; plain; snap-on type; white</p>          | <p><a href="http://www.wago.com/793-5501">www.wago.com/793-5501</a></p>                 |
|                                                                                    | <p><b>Item no.: 793-5501/000-002</b><br/>WMB marking card; as card; for terminal block width 5 - 17.5 mm; stretchable 5 - 5.2 mm; plain; snap-on type; yellow</p> | <p><a href="http://www.wago.com/793-5501/000-002">www.wago.com/793-5501/000-002</a></p> |
|  | <p><b>Item no.: 793-5501/000-005</b><br/>WMB marking card; as card; for terminal block width 5 - 17.5 mm; stretchable 5 - 5.2 mm; plain; snap-on type; red</p>    | <p><a href="http://www.wago.com/793-5501/000-005">www.wago.com/793-5501/000-005</a></p> |
|                                                                                    | <p><b>Item no.: 793-5501/000-006</b><br/>WMB marking card; as card; for terminal block width 5 - 17.5 mm; stretchable 5 - 5.2 mm; plain; snap-on type; blue</p>   | <p><a href="http://www.wago.com/793-5501/000-006">www.wago.com/793-5501/000-006</a></p> |

Subject to changes. Please also observe the further product documentation!

|                                                                                  |                                                                                                                                                                |                                                                                  |
|----------------------------------------------------------------------------------|----------------------------------------------------------------------------------------------------------------------------------------------------------------|----------------------------------------------------------------------------------|
|                                                                                  | <b>Item no.: 793-5501/000-007</b><br>WMB marking card; as card; for terminal block width 5 - 17.5 mm; stretchable 5 - 5.2 mm; plain; snap-on type; gray        | <a href="http://www.wago.com/793-5501/000-007">www.wago.com/793-5501/000-007</a> |
|                                                                                  | <b>Item no.: 793-5501/000-012</b><br>WMB marking card; as card; for terminal block width 5 - 17.5 mm; stretchable 5 - 5.2 mm; plain; snap-on type; orange      | <a href="http://www.wago.com/793-5501/000-012">www.wago.com/793-5501/000-012</a> |
|                                                                                  | <b>Item no.: 793-5501/000-017</b><br>WMB marking card; as card; for terminal block width 5 - 17.5 mm; stretchable 5 - 5.2 mm; plain; snap-on type; green       | <a href="http://www.wago.com/793-5501/000-017">www.wago.com/793-5501/000-017</a> |
|  | <b>Item no.: 793-5501/000-023</b><br>WMB marking card; as card; for terminal block width 5 - 17.5 mm; stretchable 5 - 5.2 mm; plain; snap-on type; light green | <a href="http://www.wago.com/793-5501/000-023">www.wago.com/793-5501/000-023</a> |
|                                                                                  | <b>Item no.: 793-5501/000-024</b><br>WMB marking card; as card; for terminal block width 5 - 17.5 mm; stretchable 5 - 5.2 mm; plain; snap-on type; violet      | <a href="http://www.wago.com/793-5501/000-024">www.wago.com/793-5501/000-024</a> |

## tools

|                                                                                    |                                                                                                                  |                                                                |
|------------------------------------------------------------------------------------|------------------------------------------------------------------------------------------------------------------|----------------------------------------------------------------|
|                                                                                    | <b>Item no.: 210-657</b><br>Operating tool; Blade: 3.5 x 0.5 mm; with a partially insulated shaft; short         | <a href="http://www.wago.com/210-657">www.wago.com/210-657</a> |
|   | <b>Item no.: 210-658</b><br>Operating tool; Blade: 3.5 x 0.5 mm; with a partially insulated shaft; angled; short | <a href="http://www.wago.com/210-658">www.wago.com/210-658</a> |
|  | <b>Item no.: 210-720</b><br>Operating tool; Blade: 3.5 x 0.5 mm; with a partially insulated shaft                | <a href="http://www.wago.com/210-720">www.wago.com/210-720</a> |

## General accessories

|                                                                                    |                                                                                                                                                      |                                                                |
|------------------------------------------------------------------------------------|------------------------------------------------------------------------------------------------------------------------------------------------------|----------------------------------------------------------------|
|                                                                                    | <b>Item no.: 249-120</b><br>Group marker carrier; white                                                                                              | <a href="http://www.wago.com/249-120">www.wago.com/249-120</a> |
|  | <b>Item no.: 281-407</b><br>Test plug; 6 mm wide; Nominal current 24 A; for 0.08 mm <sup>2</sup> - 2.5 mm <sup>2</sup> ; 2,50 mm <sup>2</sup> ; gray | <a href="http://www.wago.com/281-407">www.wago.com/281-407</a> |

## assembling



|                                                                                    |                                                                                                      |                                                                |
|------------------------------------------------------------------------------------|------------------------------------------------------------------------------------------------------|----------------------------------------------------------------|
|                                                                                    | <b>Item no.: 209-106</b><br>Mounting carrier; for isolated mounting on DIN 35 rails; gray            | <a href="http://www.wago.com/209-106">www.wago.com/209-106</a> |
|  | <b>Item no.: 709-153</b><br>Cover; Type 1; suitable for cover carrier, type 1; 1 m long; transparent | <a href="http://www.wago.com/709-153">www.wago.com/709-153</a> |

## Jumper

|                                                                                    |                                                                                    |                                                                |
|------------------------------------------------------------------------------------|------------------------------------------------------------------------------------|----------------------------------------------------------------|
|                                                                                    | <b>Item no.: 210-103</b><br>Wire commoning chain; insulated; 50 connections; black | <a href="http://www.wago.com/210-103">www.wago.com/210-103</a> |
|  | <b>Item no.: 210-123</b><br>Wire commoning chain; insulated; 50 connections        | <a href="http://www.wago.com/210-123">www.wago.com/210-123</a> |

Subject to changes. Please also observe the further product documentation!



|                                                                                   |                                                                                                                                                            |                                                                |
|-----------------------------------------------------------------------------------|------------------------------------------------------------------------------------------------------------------------------------------------------------|----------------------------------------------------------------|
|                                                                                   | <b>Item no.: 249-123</b><br>Push-in type wire jumper; insulated; wire length 180 mm; Conductor cross section 0.75 mm <sup>2</sup>                          | <a href="http://www.wago.com/249-123">www.wago.com/249-123</a> |
|   | <b>Item no.: 249-125</b><br>Push-in type wire jumper; insulated; wire length 60 mm; Conductor cross section 0.75 mm <sup>2</sup>                           | <a href="http://www.wago.com/249-125">www.wago.com/249-125</a> |
|                                                                                   | <b>Item no.: 249-126</b><br>Push-in type wire jumper; insulated; wire length 110 mm; Conductor cross section 0.75 mm <sup>2</sup>                          | <a href="http://www.wago.com/249-126">www.wago.com/249-126</a> |
|   | <b>Item no.: 249-127</b><br>Push-in type wire jumper; insulated; wire length 250 mm; Conductor cross section 0.75 mm <sup>2</sup>                          | <a href="http://www.wago.com/249-127">www.wago.com/249-127</a> |
|                                                                                   | <b>Item no.: 281-402</b><br>Adjacent jumper; insulated; IN = IN terminal block; gray                                                                       | <a href="http://www.wago.com/281-402">www.wago.com/281-402</a> |
|                                                                                   | <b>Item no.: 709-110</b><br>Wire commoning chain; insulated; 4 connections; 3 x 110 mm; black                                                              | <a href="http://www.wago.com/709-110">www.wago.com/709-110</a> |
|                                                                                   | <b>Item no.: 709-111</b><br>Wire commoning chain; insulated; 3 connections; 2 x 120 mm; black                                                              | <a href="http://www.wago.com/709-111">www.wago.com/709-111</a> |
|                                                                                   | <b>Item no.: 709-112</b><br>Wire commoning chain; insulated; 3 connections; 2 x 170 mm; black                                                              | <a href="http://www.wago.com/709-112">www.wago.com/709-112</a> |
| <b>Test Accessories</b>                                                           |                                                                                                                                                            |                                                                |
|  | <b>Item no.: 210-137</b><br>Test plug; 2.3 mm Ø; with 500 mm cable; yellow                                                                                 | <a href="http://www.wago.com/210-137">www.wago.com/210-137</a> |
|                                                                                   | <b>Item no.: 280-404</b><br>Test plug adapter; 5 mm wide; for test plug 210-137 (2.3 mm Ø); suitable for 1.5 mm <sup>2</sup> - 4 mm <sup>2</sup> tbs; gray | <a href="http://www.wago.com/280-404">www.wago.com/280-404</a> |
| <b>End plate</b>                                                                  |                                                                                                                                                            |                                                                |
|                                                                                   | <b>Item no.: 281-309</b><br>End and intermediate plate; 2.5 mm thick; orange                                                                               | <a href="http://www.wago.com/281-309">www.wago.com/281-309</a> |
|                                                                                   | <b>Item no.: 281-311</b><br>End and intermediate plate; 2.5 mm thick; gray                                                                                 | <a href="http://www.wago.com/281-311">www.wago.com/281-311</a> |
| <b>N-busbar</b>                                                                   |                                                                                                                                                            |                                                                |
|                                                                                   | <b>Item no.: 210-254</b><br>Interlocking link; mechanically locks multiple links; 1 m long; transparent                                                    | <a href="http://www.wago.com/210-254">www.wago.com/210-254</a> |

## Downloads

### Documentation

#### Additional Information

|                        |             |               |          |
|------------------------|-------------|---------------|----------|
| Technical explanations | Apr 3, 2019 | pdf<br>2.1 MB | Download |
|------------------------|-------------|---------------|----------|

Subject to changes. Please also observe the further product documentation!

## CAD/CAE-Data

### CAD data

2D/3D Models 281-612/281-418

[URL](#)

[Download](#)

### CAE data

EPLAN Data Portal 281-612/281-418

[URL](#)

[Download](#)

WSCAD Universe 281-612/281-418

[URL](#)

[Download](#)

## Installation Notes

### Conductor termination

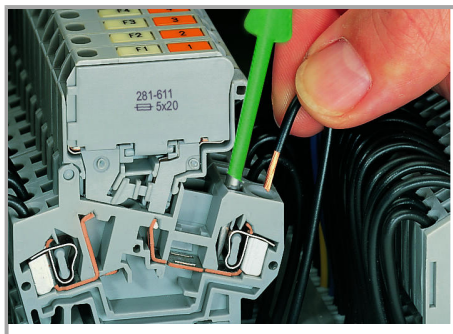

### CAGE CLAMP® connection

Inserting a conductor via screwdriver.

With ferruled conductors, it is necessary to use a terminal block one size smaller than the conductor's nominal cross section.

### Commoning

Subject to changes. Please also observe the further product documentation!

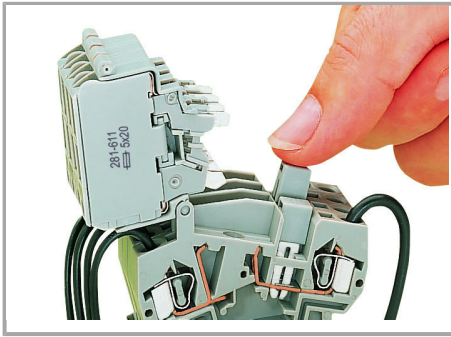

**Commoning:**

Distributing current to several fuse-protected circuits via insulated push-in type jumpers.

**Testing**

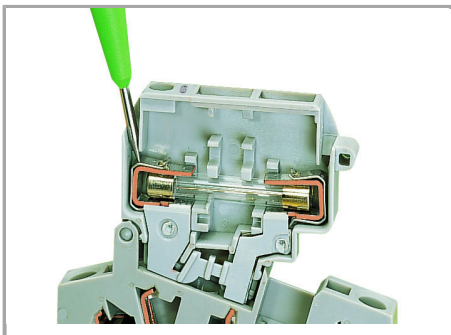

Voltage test, either at input or output with fuse holder in closed position (live)

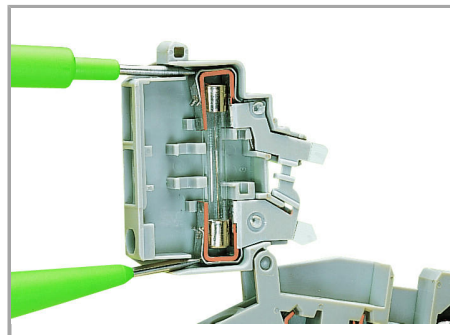

Through test with fuse holder in open position (no voltage)

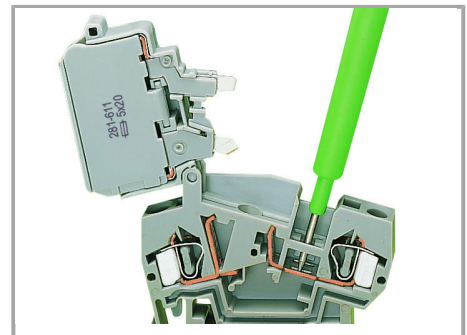

Voltage test at input in the test slot of the current bar

Subject to changes. Please also observe the further product documentation!

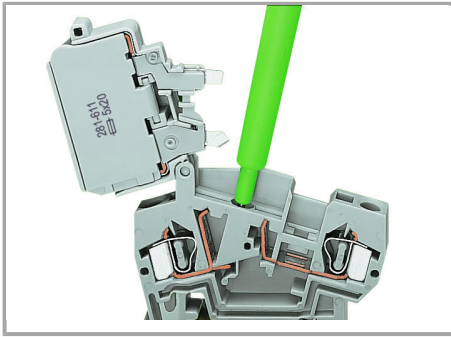

Testing voltage at the output via separate test slot.

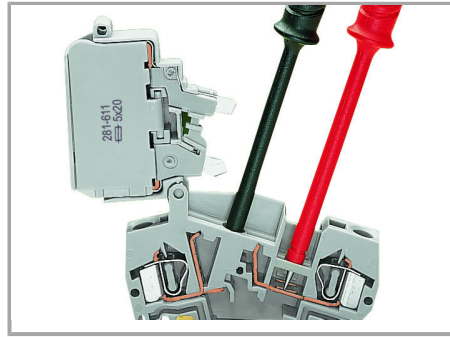

Measuring current between jumper slot and separate test slot.

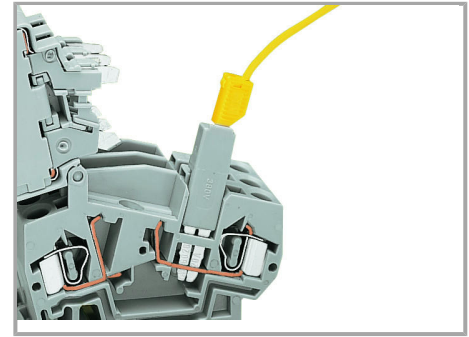

Testing voltage (input side) via test plug adapter (280-404, shown) or test plug (281-407).

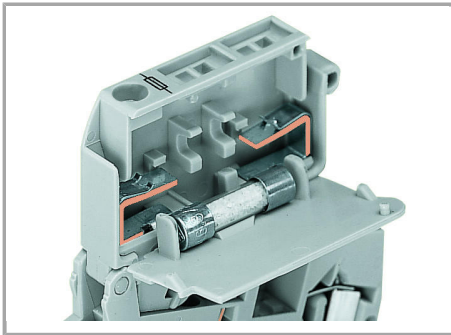

5 x 20 mm, 5 x 25 mm and 1/4" x 1" fuse holders are fitted with stops on the inside of the cover.

### Safety

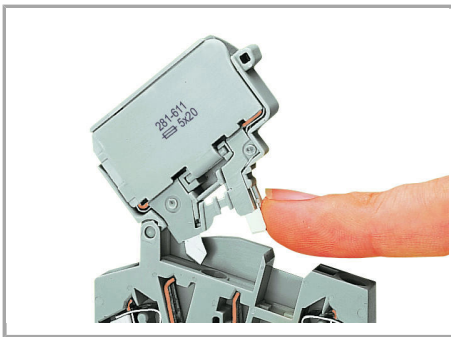

Touch-proof protection in all positions of the fuse holder

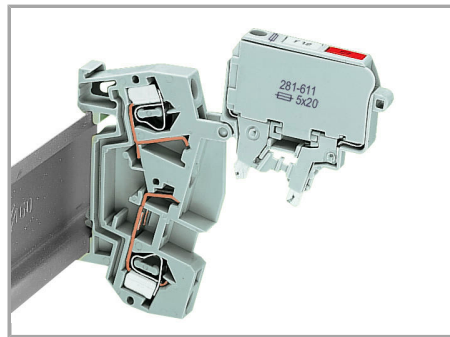

Fuse holder will remain safely locked open in vertical assemblies.

### Locking lever

Subject to changes. Please also observe the further product documentation!

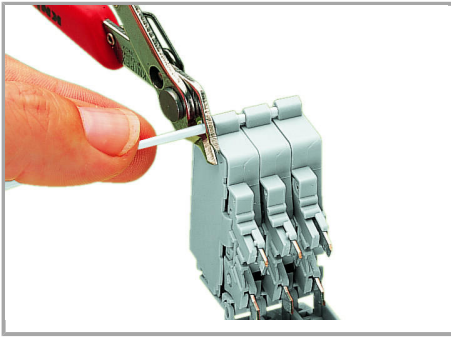

Ganging several fuse holders with an interlocking link (example shows 8 mm wide terminal blocks).

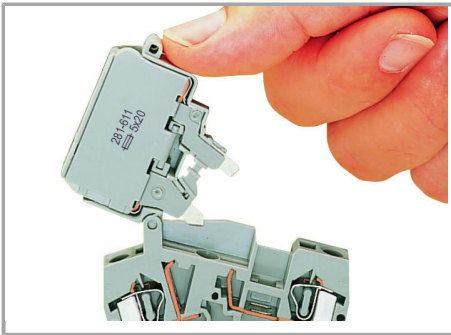

**Fuse replacement:**

Before replacing a fuse, pivot the fuse holder into the locked open position.

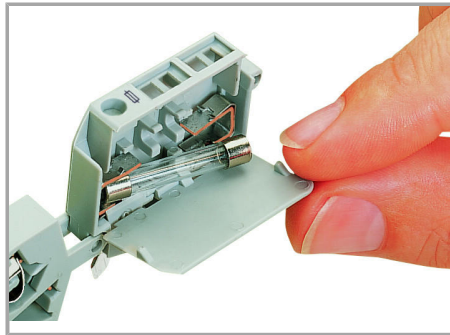

**Fuse replacement:**

One end of the fuse is automatically ejected from the holder when opening the cover.

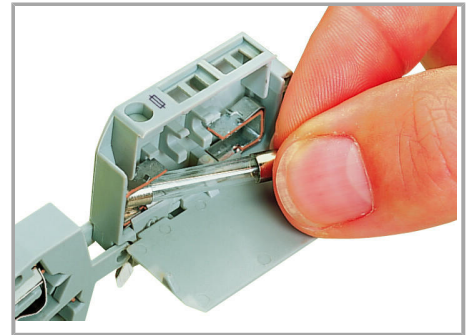

**Fuse replacement:**

Easily removing a fuse by hand.

Subject to changes. Please also observe the further product documentation!

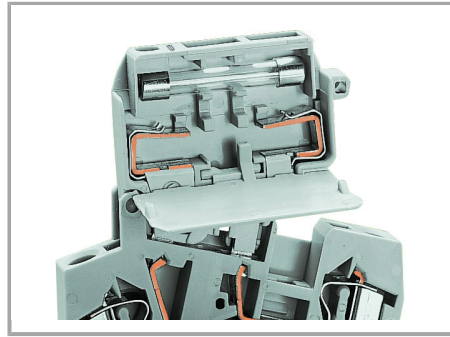
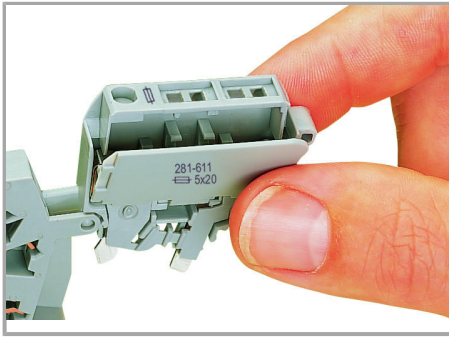

**Fuse replacement:**

Storing a spare fuse (fuse holder without blown fuse indication).

Insert a new fuse and snap the cover closed.

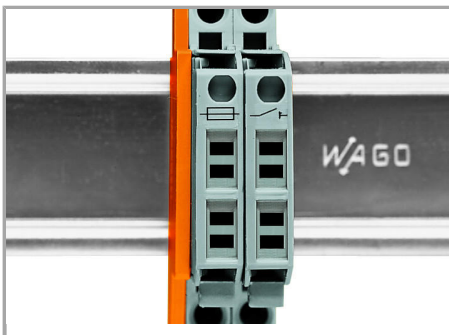

Fused disconnect or disconnect terminal blocks with a width of 8 mm can be assembled adjacently. At the end of an assembly or if there is **no** adjacent fused disconnect or disconnect terminal block, an end or intermediate plate must be used.

**Marking**

Subject to changes. Please also observe the further product documentation!

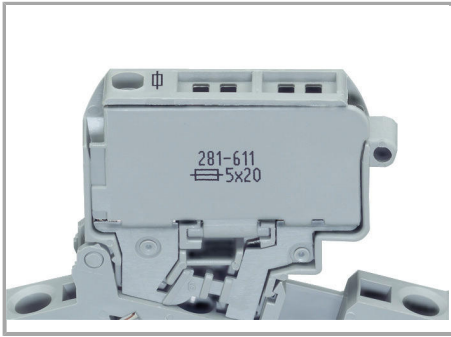

Fuse holders are printed with correct fuse size.

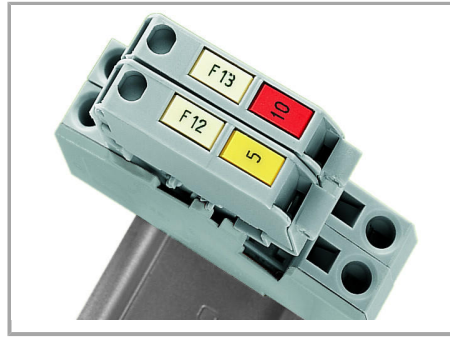

Each fuse holder features two marker slots for custom WMB Multi markers (example shows 8 mm wide terminal blocks).

Subject to changes. Please also observe the further product documentation!