

Data sheet | Item number: 280-944/281-590

Component terminal block; double-deck; with end plate; with 1.5KE62C TVS diode; 48 VDC; for DIN-rail 35 x 15 and 35 x 7.5; 2.5 mm²; CAGE CLAMP®; 2,50 mm²; gray

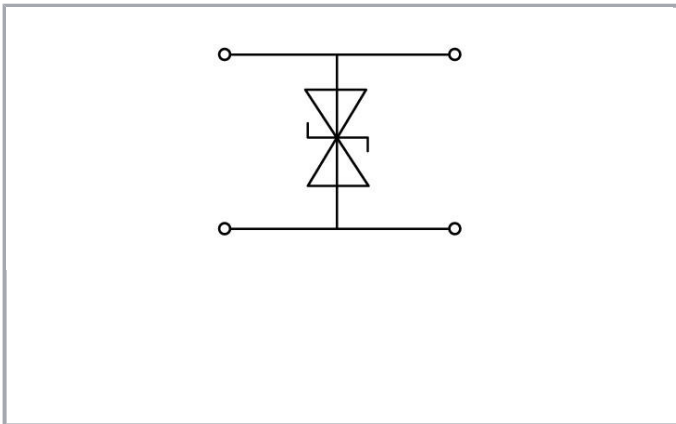

www.wago.com/280-944/281-590

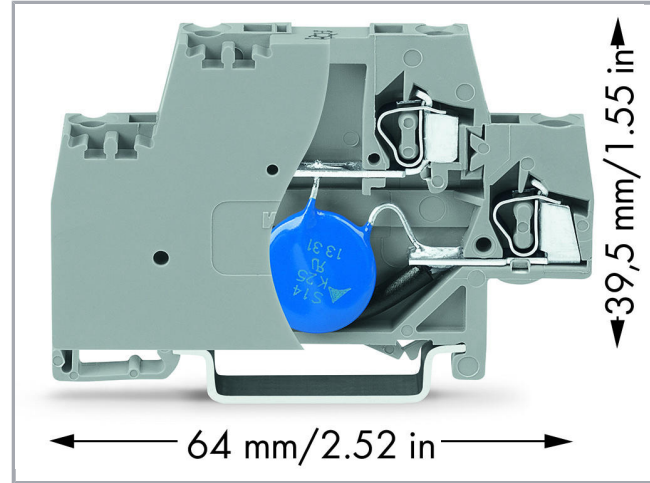
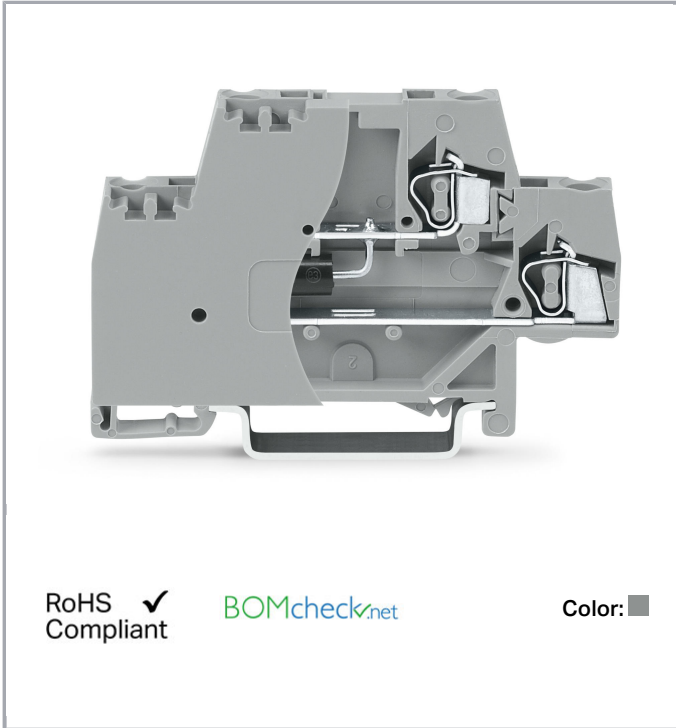

Item description

Short description:

Subject to changes. Please also observe the further product documentation!

WAGO Kontakttechnik GmbH & Co. KG
Hansastr. 27
32423 Minden
Phone: +49571 887-0 | Fax: +49571 887-169
Email: info.de@wago.com | Web: www.wago.com

Do you have any questions about our products?
We are always happy to take your call at +49 (571) 887-44222.



Terminal blocks with surge suppression device and direct connection to the DIN-35 rail; these single-stage surge suppression devices are equipped either with 280 Series gas-filled surge arrester (coarse), varistor (medium) or suppressor diode (fine).

Features:

- Protect your system against overvoltage
- Slim, space-saving design
- Control operational costs by preventing expensive, unplanned downtime
- High operational reliability and system uptime

Data

Electrical data

Nominal operating voltage	DC 48 V
Maximum continuous operating voltage	DC 53 V
Rated continuous current	20 A
Nominal discharge current (8/20 μ s) per line	90 A
Voltage protection level (8/20 μ s)	\leq DC 111 V
Capacitance	\leq 1.7 nF

Connection data

Connections (number)	4
Connection technology	CAGE CLAMP [®]
Solid conductor	0.08 ... 2.5 mm ² / 28 ... 14 AWG
Fine-stranded conductor	0.08 ... 2.5 mm ² / 28 ... 14 AWG
Strip length	8 ... 9 mm / 0.31 ... 0.35 inch

Geometrical Data

Width	10 mm / 0.394 inch
Height from upper-edge of DIN-35 rail	39.5 mm / 1.555 inch
Depth	64 mm / 2.52 inch

Mechanical data

Design	With end plate
Type of mounting	DIN-35 rail

Material Data

Color	gray
-------	------

Subject to changes. Please also observe the further product documentation!









Fire load	0.271 MJ
Weight	14 g

Commercial data

Product Group	1 (Rail Mounted Terminal Blocks)
Packaging type	BOX
Country of origin	DE
GTIN	4050821515074
Customs Tariff No.	85369010000













Counterpart**Compatible products****Marking accessories**

	Item no.: 2009-145 Mini-WSB Inline; for Smart Printer; 1700 pieces on roll; stretchable 5 - 5.2 mm; plain; snap-on type; white	www.wago.com/2009-145
	Item no.: 2009-145/000-002 Mini-WSB Inline; for Smart Printer; 1700 pieces on roll; stretchable 5 - 5.2 mm; plain; snap-on type; white	www.wago.com/2009-145/000-002
	Item no.: 2009-145/000-005 Mini-WSB Inline; for Smart Printer; 1700 pieces on roll; stretchable 5 - 5.2 mm; plain; snap-on type; red	www.wago.com/2009-145/000-005
	Item no.: 2009-145/000-006 Mini-WSB Inline; for Smart Printer; 1700 pieces on roll; stretchable 5 - 5.2 mm; plain; snap-on type; blue	www.wago.com/2009-145/000-006
	Item no.: 2009-145/000-007 Mini-WSB Inline; for Smart Printer; 1700 pieces on roll; stretchable 5 - 5.2 mm; plain; snap-on type; white	www.wago.com/2009-145/000-007
	Item no.: 2009-145/000-012 Mini-WSB Inline; for Smart Printer; 1700 pieces on roll; stretchable 5 - 5.2 mm; plain; snap-on type; orange	www.wago.com/2009-145/000-012
	Item no.: 2009-145/000-023 Mini-WSB Inline; for Smart Printer; 1700 pieces on roll; stretchable 5 - 5.2 mm; plain; snap-on type; green	www.wago.com/2009-145/000-023

Subject to changes. Please also observe the further product documentation!

WAGO Kontakttechnik GmbH & Co. KG
Hansastr. 27
32423 Minden
Phone: +49571 887-0 | Fax: +49571 887-169
Email: info.de@wago.com | Web: www.wago.com





Do you have any questions about our products?
We are always happy to take your call at +49 (571) 887-44222.

	<p>Item no.: 2009-145/000-024 Mini-WSB Inline; for Smart Printer; 1700 pieces on roll; stretchable 5 - 5.2 mm; plain; snap-on type; violet</p>	www.wago.com/2009-145/000-024
	<p>Item no.: 248-501 Miniature WSB Quick marking system; plain; Marker width 5 mm; 10 strips with 10 markers per card</p>	www.wago.com/248-501
	<p>Item no.: 248-501/000-002 Mini-WSB marking card; as card; not stretchable; plain; snap-on type; yellow</p>	www.wago.com/248-501/000-002
	<p>Item no.: 248-501/000-005 Mini-WSB marking card; as card; not stretchable; plain; snap-on type; red</p>	www.wago.com/248-501/000-005
	<p>Item no.: 248-501/000-006 Mini-WSB marking card; as card; not stretchable; plain; snap-on type; blue</p>	www.wago.com/248-501/000-006
	<p>Item no.: 248-501/000-007 Mini-WSB marking card; as card; not stretchable; plain; snap-on type; gray</p>	www.wago.com/248-501/000-007
	<p>Item no.: 248-501/000-012 Mini-WSB marking card; as card; not stretchable; plain; snap-on type; orange</p>	www.wago.com/248-501/000-012
	<p>Item no.: 248-501/000-017 Mini-WSB marking card; as card; not stretchable; plain; snap-on type; light green</p>	www.wago.com/248-501/000-017
	<p>Item no.: 248-501/000-023 Mini-WSB marking card; as card; not stretchable; plain; snap-on type; green</p>	www.wago.com/248-501/000-023
	<p>Item no.: 248-501/000-024 Mini-WSB marking card; as card; not stretchable; plain; snap-on type; violet</p>	www.wago.com/248-501/000-024
tools		
	<p>Item no.: 210-720 Operating tool; Blade: 3.5 x 0.5 mm; with a partially insulated shaft</p>	www.wago.com/210-720
Insulation stop		
	<p>Item no.: 280-470 Insulation stop; 0.08 - 0.2 mm² "s" (0.14 mm² "f-st"); 5 pieces/strip; white</p>	www.wago.com/280-470
	<p>Item no.: 280-471 Insulation stop; 0.25 - 0.5 mm²; 5 pieces/strip; light gray</p>	www.wago.com/280-471
	<p>Item no.: 280-472 Insulation stop; 0.75 - 1 mm²; 5 pieces/strip</p>	www.wago.com/280-472

Jumper

Subject to changes. Please also observe the further product documentation!



	Item no.: 280-482 Comb-style jumper bar; insulated; 2-way; IN = IN terminal block; gray	www.wago.com/280-482
	Item no.: 280-483 Comb-style jumper bar; insulated; 3-way; IN = IN terminal block; gray	www.wago.com/280-483
	Item no.: 280-484 Comb-style jumper bar; insulated; 4-way; IN = IN terminal block; gray	www.wago.com/280-484
	Item no.: 280-485 Comb-style jumper bar; insulated; 5-way; IN = IN terminal block; gray	www.wago.com/280-485
	Item no.: 280-490 Comb-style jumper bar; insulated; 10-way; IN = IN terminal block; gray	www.wago.com/280-490
	Item no.: 280-492 Alternate comb-style jumper bar; insulated; 2-way; IN = IN terminal block; gray	www.wago.com/280-492

Downloads

Documentation

Additional Information

Disposal; Electrical and electronic equipment, Packaging	V 1.0.0	pdf 265.8 kB	Download
--	---------	-----------------	----------

CAD/CAE-Data

CAE data

EPLAN Data Portal 280-944/281-590	URL	Download
WSCAD Universe 280-944/281-590	URL	Download

Installation Notes

Subject to changes. Please also observe the further product documentation!

WAGO Kontakttechnik GmbH & Co. KG
Hansastr. 27
32423 Minden
Phone: +49571 887-0 | Fax: +49571 887-169
Email: info.de@wago.com | Web: www.wago.com

Do you have any questions about our products?
We are always happy to take your call at +49 (571) 887-44222.