

Data sheet | Item number: 280-803

Empty component plug housing; 10 mm wide; Type 4; 2-pole; gray

[www.wago.com/280-803](http://www.wago.com/280-803)

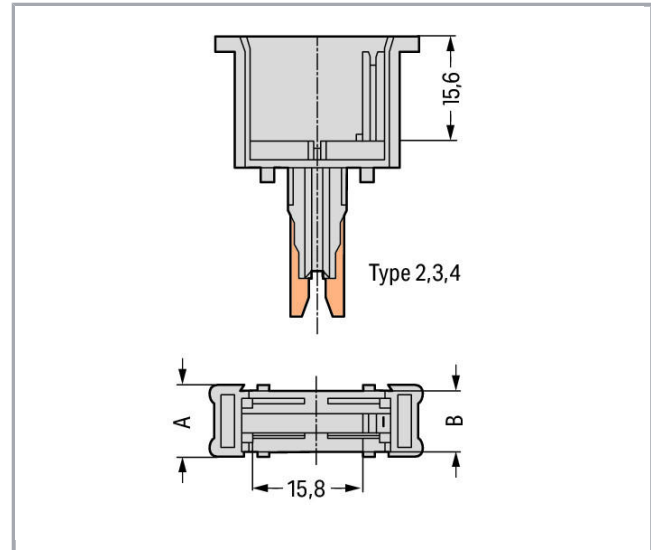
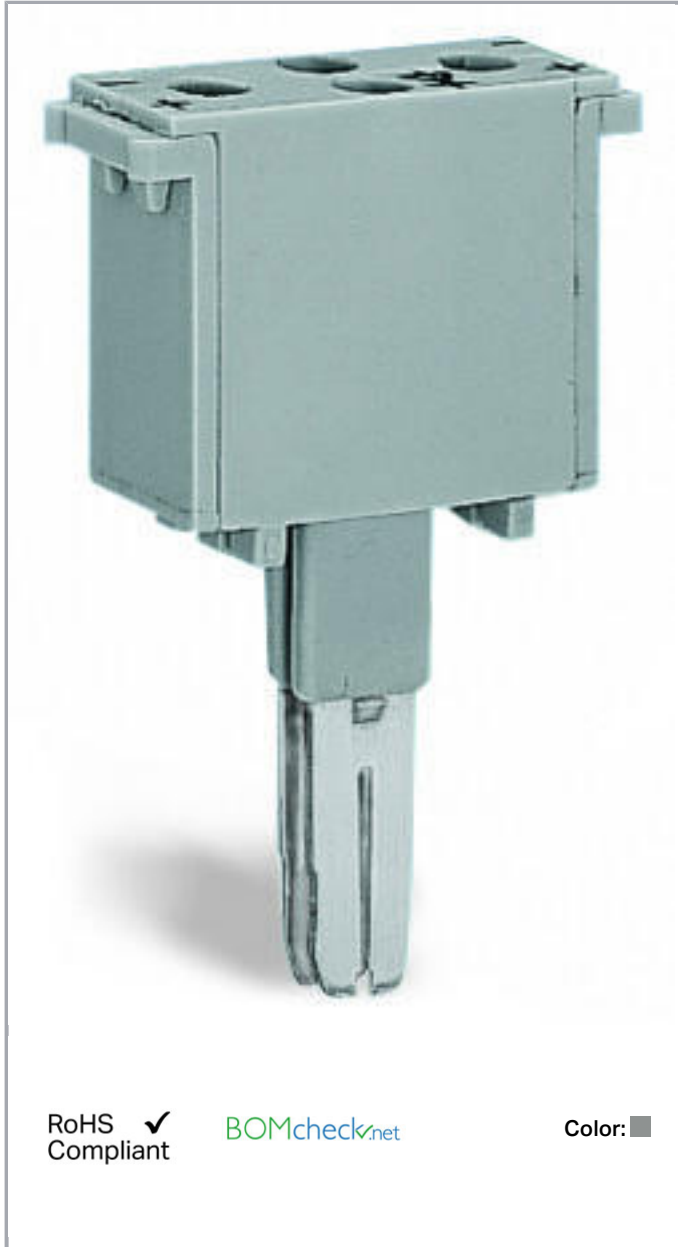

## Item description

Subject to changes. Please also observe the further product documentation!

WAGO Kontakttechnik GmbH & Co. KG  
Hansastr. 27  
32423 Minden  
Phone: +49571 887-0 | Fax: +49571 887-169  
Email: [info.de@wago.com](mailto:info.de@wago.com) | Web: [www.wago.com](http://www.wago.com)

Do you have any questions about our products?  
We are always happy to take your call at +49 (571) 887-44222.



Empty component plug housing, type 4

**Note:**

Inside dimensions of plug W/H/D 8.2/15/15 mm (0.323/0.591/0.591 in)

**Data**

**Electrical data**

Rated continuous current	6 A
--------------------------	-----

**Safety and protection:**

Rated voltage	250 V
Rated impulse voltage	4 kV
Pollution degree	3

**Connection data**

No. of poles	2
Type of wiring	Front-entry wiring

**Geometrical Data**

Width	10 mm / 0.394 inch
-------	--------------------

**Mechanical data**

Housing design	Pluggable module for terminal blocks
Type of mounting	Pluggable module for carrier terminal block

**Material Data**

Color	gray
Fire load	0.072 MJ
Weight	3.9 g

**Commercial data**

Product Group	1 (Rail Mounted Terminal Blocks)
Packaging type	BOX
Country of origin	DE









Subject to changes. Please also observe the further product documentation!

GTIN	4044918270397
Customs Tariff No.	85366990990

## Counterpart

## Compatible products

### Terminal Block

	<b>Item no.: 280-101</b> 2-conductor through terminal block; 2.5 mm <sup>2</sup> ; lateral marker slots; for DIN-rail 35 x 15 and 35 x 7.5; CAGE CLAMP®; 2,50 mm <sup>2</sup> ; gray	<a href="http://www.wago.com/280-101">www.wago.com/280-101</a>
	<b>Item no.: 280-601</b> 2-conductor through terminal block; 2.5 mm <sup>2</sup> ; lateral marker slots; for DIN-rail 35 x 15 and 35 x 7.5; CAGE CLAMP®; 2,50 mm <sup>2</sup> ; gray	<a href="http://www.wago.com/280-601">www.wago.com/280-601</a>
	<b>Item no.: 280-603</b> 4-conductor through terminal block; 2.5 mm <sup>2</sup> ; center marking; for DIN-rail 35 x 15 and 35 x 7.5; CAGE CLAMP®; 2,50 mm <sup>2</sup> ; orange	<a href="http://www.wago.com/280-603">www.wago.com/280-603</a>
	<b>Item no.: 280-621</b> 4-conductor through terminal block; 2.5 mm <sup>2</sup> ; lateral marker slots; for DIN-rail 35 x 15 and 35 x 7.5; CAGE CLAMP®; 2,50 mm <sup>2</sup> ; gray	<a href="http://www.wago.com/280-621">www.wago.com/280-621</a>
	<b>Item no.: 280-633</b> 4-conductor through terminal block; 2.5 mm <sup>2</sup> ; center marking; for DIN-rail 35 x 15 and 35 x 7.5; CAGE CLAMP®; 2,50 mm <sup>2</sup> ; gray	<a href="http://www.wago.com/280-633">www.wago.com/280-633</a>
	<b>Item no.: 280-681</b> 3-conductor through terminal block; 2.5 mm <sup>2</sup> ; center marking; for DIN-rail 35 x 15 and 35 x 7.5; CAGE CLAMP®; 2,50 mm <sup>2</sup> ; gray	<a href="http://www.wago.com/280-681">www.wago.com/280-681</a>
	<b>Item no.: 280-833</b> 4-conductor through terminal block; 2.5 mm <sup>2</sup> ; center marking; for DIN-rail 35 x 15 and 35 x 7.5; CAGE CLAMP®; 2,50 mm <sup>2</sup> ; gray	<a href="http://www.wago.com/280-833">www.wago.com/280-833</a>
	<b>Item no.: 280-901</b> 2-conductor through terminal block; 2.5 mm <sup>2</sup> ; center marking; for DIN-rail 35 x 15 and 35 x 7.5; CAGE CLAMP®; 2,50 mm <sup>2</sup> ; gray	<a href="http://www.wago.com/280-901">www.wago.com/280-901</a>

## Downloads

### Documentation

#### Additional Information

Disposal; Electrical and electronic equipment, Packaging	V 1.0.0	pdf 265.8 kB	Download
--	---------	-----------------	----------

## CAD/CAE-Data

### CAD data

Subject to changes. Please also observe the further product documentation!

WAGO Kontakttechnik GmbH & Co. KG  
Hansastr. 27  
32423 Minden  
Phone: +49571 887-0 | Fax: +49571 887-169  
Email: [info.de@wago.com](mailto:info.de@wago.com) | Web: [www.wago.com](http://www.wago.com)

Do you have any questions about our products?  
We are always happy to take your call at +49 (571) 887-44222.



2D/3D Models 280-803	<a href="#">URL</a>	<a href="#">Download</a>
<hr/>		
<b>CAE data</b>		
WSCAD Universe 280-803	<a href="#">URL</a>	<a href="#">Download</a>
<hr/>		

## Installation Notes

Subject to changes. Please also observe the further product documentation!

WAGO Kontakttechnik GmbH & Co. KG  
Hansastr. 27  
32423 Minden  
Phone: +49571 887-0 | Fax: +49571 887-169  
Email: [info.de@wago.com](mailto:info.de@wago.com) | Web: [www.wago.com](http://www.wago.com)

Do you have any questions about our products?  
We are always happy to take your call at +49 (571) 887-44222.