

Data sheet | Item number: 280-525

Double-deck terminal block; for DIN-rail 35 x 15 and 35 x 7.5; 2.5 mm²; CAGE CLAMP®; 2,50 mm²; blue/gray

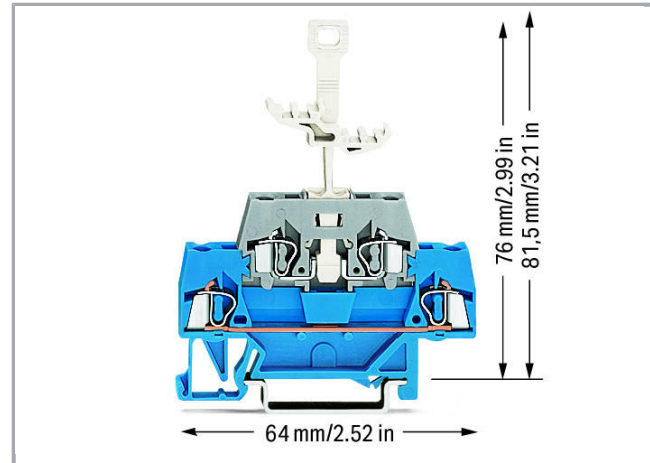

www.wago.com/280-525

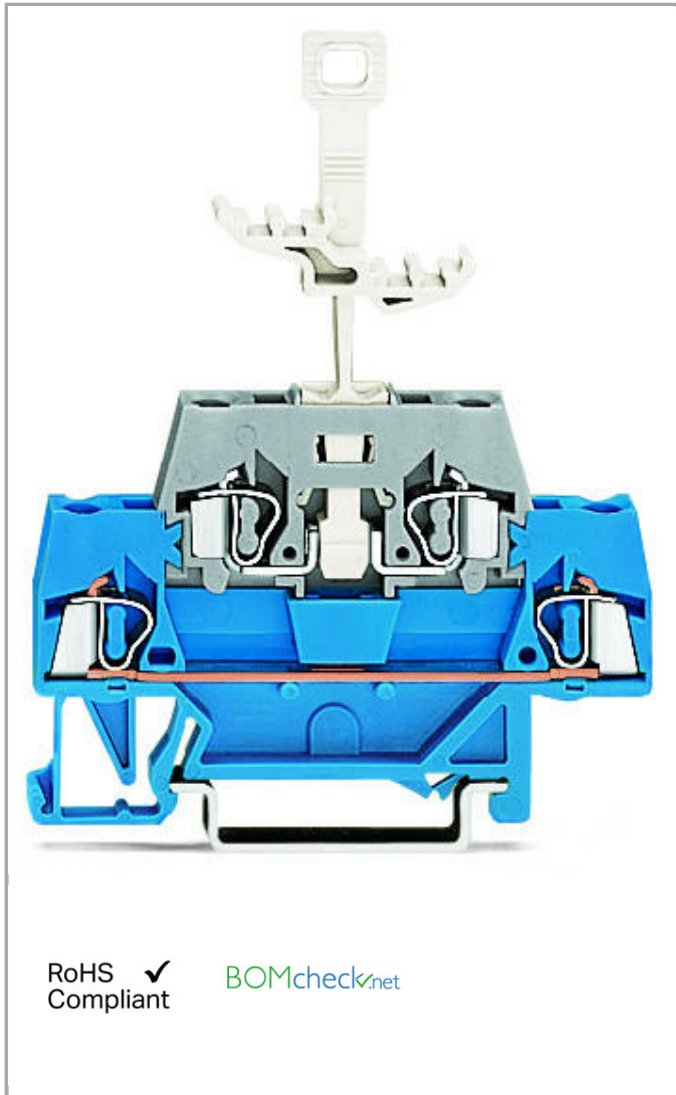

Subject to changes. Please also observe the further product documentation!

WAGO Kontakttechnik GmbH & Co. KG
Hansastr. 27
32423 Minden
Phone: +49571 887-0 | Fax: +49571 887-169
Email: info.de@wago.com | Web: www.wago.com

Do you have any questions about our products?
We are always happy to take your call at +49 (571) 887-44222.

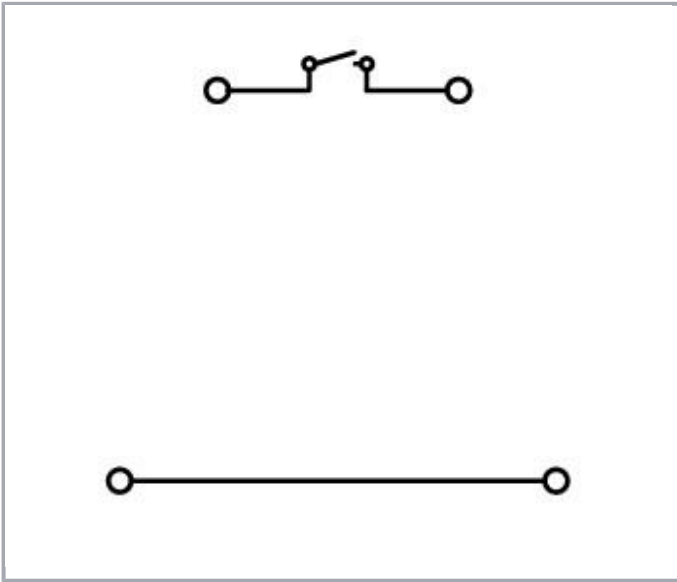

Item description

Note:

Terminating Aluminum Conductors

WAGO spring clamp terminal blocks are suitable for solid aluminum conductors up to 4 mm²/12 AWG if WAGO "Alu-Plus" Contact Paste is used for termination.

"Alu-Plus" Contact Paste Advantages:

- Automatically destroys the oxide film during clamping.
- Prevents fresh oxidation at the clamping point.
- Prevents electrolytic corrosion between aluminum and copper conductors (in the same terminal block).
- Provides long-term protection against corrosion.

Using terminal blocks with CAGE CLAMP® Spring Pressure Connection Technology, **aluminum conductors must first be cleaned with a blade** and then immediately be inserted into the clamping units filled with "Alu-Plus" Contact Paste.

It is also possible to apply WAGO "Alu-Plus" **additionally** on the whole surface of the aluminum conductor before termination.

Please note that the nominal currents must be adapted to the reduced conductivity of the aluminum conductors:

2.5 mm² (14 AWG) = 16 A

4 mm² (12 AWG) = 22 A

Data

Electrical data

Subject to changes. Please also observe the further product documentation!



Ratings per IEC/EN 60664-1

Ratings per	IEC/EN 60947-7-1
Rated voltage (III / 3)	400 V
Rated impulse voltage (III / 3)	6 kV
Rated current	10 A
Legend (ratings)	(III / 3) \triangleq Overvoltage category III / Pollution degree 3

Connection data

Connection technology	CAGE CLAMP®
Actuation type	Operating tool
Connectable conductor materials	Copper Aluminum
Solid conductor	0.08 ... 2.5 mm ² / 28 ... 12 AWG
Fine-stranded conductor	0.08 ... 2.5 mm ² / 28 ... 12 AWG
Strip length	8 ... 9 mm / 0.31 ... 0.35 inch
Total number of connection points	4
Total number of potentials	3
Number of levels	2
Type of wiring	Front-entry wiring
Note (conductor cross-section)	12 AWG: THHN, THWN

Geometrical Data

Width	5 mm / 0.197 inch
Height from upper-edge of DIN-35 rail	81.5 mm / 3.209 inch
Depth	64 mm / 2.52 inch

Mechanical data

Design	horizontal
Type of mounting	DIN-35 rail
Marking level	Center marking

Material Data

Color	blue/gray
Insulating material	Polyamide 66 (PA 66)
Fire load	0.17 MJ
Weight	10.2 g



Subject to changes. Please also observe the further product documentation!

Commercial data



Product Group	1 (Rail Mounted Terminal Blocks)
Packaging type	BOX
Country of origin	DE
GTIN	4044918539012
Customs Tariff No.	8536901000

Approvals / Certificates

Country specific Approvals

Logo	Approval	Additional Approval Text	Certificate name
	CCA DEKRA Certification B.V.	EN 60947	2157201.01
	CSA DEKRA Certification B.V.	C22.2	1536071

Ship Approvals

Logo	Approval	Additional Approval Text	Certificate name
	ABS American Bureau of Shipping	EN 60947	20- HG1941090- PDA
	BV Bureau Veritas S.A.	EN 60947	07436/E0 BV
	LR Lloyds Register	EN 60947	91/20112 (E9)

UL-Approvals

Logo	Approval	Additional Approval Text	Certificate name
	UR Underwriters Laboratories Inc.	UL 1059	20190731- E45172







Subject to changes. Please also observe the further product documentation!



Counterpart

Compatible products













Marking accessories

	Item no.: 2009-115 WMB-Inline; for Smart Printer; 1500 pieces on roll; stretchable 5 - 5.2 mm; plain; snap-on type; white	www.wago.com/2009-115
	Item no.: 2009-115/000-002 WMB-Inline; for Smart Printer; 1500 pieces on roll; stretchable 5 - 5.2 mm; plain; snap-on type; yellow	www.wago.com/2009-115/000-002
	Item no.: 2009-115/000-006 WMB-Inline; for Smart Printer; 1500 pieces on roll; stretchable 5 - 5.2 mm; plain; snap-on type; white	www.wago.com/2009-115/000-006
	Item no.: 2009-115/000-007 WMB-Inline; for Smart Printer; 1500 pieces on roll; stretchable 5 - 5.2 mm; plain; snap-on type; gray	www.wago.com/2009-115/000-007
	Item no.: 2009-115/000-012 WMB-Inline; for Smart Printer; 1500 pieces on roll; stretchable 5 - 5.2 mm; plain; snap-on type; white	www.wago.com/2009-115/000-012
	Item no.: 2009-115/000-017 WMB-Inline; for Smart Printer; 1500 pieces on roll; stretchable 5 - 5.2 mm; plain; snap-on type; white	www.wago.com/2009-115/000-017
	Item no.: 2009-115/000-023 WMB-Inline; for Smart Printer; 1500 pieces on roll; stretchable 5 - 5.2 mm; plain; snap-on type; green	www.wago.com/2009-115/000-023

Subject to changes. Please also observe the further product documentation!

WAGO Kontakttechnik GmbH & Co. KG
Hansastr. 27
32423 Minden
Phone: +49571 887-0 | Fax: +49571 887-169
Email: info.de@wago.com | Web: www.wago.com

Do you have any questions about our products?
We are always happy to take your call at +49 (571) 887-44222.

	<p>Item no.: 2009-115/000-024 WMB In-line; for Smart Printer; 1500 pieces on roll; stretchable 5 - 5.2 mm; plain; snap-on type; white</p>	www.wago.com/2009-115/000-024
	<p>Item no.: 793-501 WMB marking card; as card; not stretchable; plain; snap-on type; white</p>	www.wago.com/793-501
	<p>Item no.: 793-501/000-002 WMB marking card; as card; not stretchable; plain; snap-on type; yellow</p>	www.wago.com/793-501/000-002
	<p>Item no.: 793-501/000-005 WMB marking card; as card; not stretchable; plain; snap-on type; red</p>	www.wago.com/793-501/000-005
	<p>Item no.: 793-501/000-006 WMB marking card; as card; not stretchable; plain; snap-on type; blue</p>	www.wago.com/793-501/000-006
	<p>Item no.: 793-501/000-007 WMB marking card; as card; not stretchable; plain; snap-on type; gray</p>	www.wago.com/793-501/000-007
	<p>Item no.: 793-501/000-012 WMB marking card; as card; not stretchable; plain; snap-on type; orange</p>	www.wago.com/793-501/000-012
	<p>Item no.: 793-501/000-017 WMB marking card; as card; not stretchable; plain; snap-on type; light green</p>	www.wago.com/793-501/000-017
	<p>Item no.: 793-501/000-023 WMB marking card; as card; not stretchable; plain; snap-on type; green</p>	www.wago.com/793-501/000-023
	<p>Item no.: 793-501/000-024 WMB marking card; as card; not stretchable; plain; snap-on type; violet</p>	www.wago.com/793-501/000-024
	<p>Item no.: 793-5501 WMB marking card; as card; for terminal block width 5 - 17.5 mm; stretchable 5 - 5.2 mm; plain; snap-on type; white</p>	www.wago.com/793-5501
	<p>Item no.: 793-5501/000-002 WMB marking card; as card; for terminal block width 5 - 17.5 mm; stretchable 5 - 5.2 mm; plain; snap-on type; yellow</p>	www.wago.com/793-5501/000-002
	<p>Item no.: 793-5501/000-005 WMB marking card; as card; for terminal block width 5 - 17.5 mm; stretchable 5 - 5.2 mm; plain; snap-on type; red</p>	www.wago.com/793-5501/000-005
	<p>Item no.: 793-5501/000-006 WMB marking card; as card; for terminal block width 5 - 17.5 mm; stretchable 5 - 5.2 mm; plain; snap-on type; blue</p>	www.wago.com/793-5501/000-006

Subject to changes. Please also observe the further product documentation!



Item no.: 793-5501/000-007

WMB marking card; as card; for terminal block width 5 - 17.5 mm; stretchable 5 - 5.2 mm; plain; snap-on type; gray

www.wago.com/793-5501/000-007



Item no.: 793-5501/000-012

WMB marking card; as card; for terminal block width 5 - 17.5 mm; stretchable 5 - 5.2 mm; plain; snap-on type; orange

www.wago.com/793-5501/000-012



Item no.: 793-5501/000-017

WMB marking card; as card; for terminal block width 5 - 17.5 mm; stretchable 5 - 5.2 mm; plain; snap-on type; green

www.wago.com/793-5501/000-017



Item no.: 793-5501/000-023

WMB marking card; as card; for terminal block width 5 - 17.5 mm; stretchable 5 - 5.2 mm; plain; snap-on type; light green

www.wago.com/793-5501/000-023



Item no.: 793-5501/000-024

WMB marking card; as card; for terminal block width 5 - 17.5 mm; stretchable 5 - 5.2 mm; plain; snap-on type; violet

www.wago.com/793-5501/000-024

ferrule



Item no.: 216-101

Ferrule; Sleeve for 0.5 mm² / AWG 22; uninsulated; electro-tin plated

www.wago.com/216-101

Item no.: 216-102

Ferrule; Sleeve for 0.75 mm² / AWG 20; uninsulated; electro-tin plated

www.wago.com/216-102



Item no.: 216-103

Ferrule; Sleeve for 1 mm² / AWG 18; uninsulated; electro-tin plated

www.wago.com/216-103

Item no.: 216-104

Ferrule; Sleeve for 1.5 mm² / AWG 16; uninsulated; electro-tin plated

www.wago.com/216-104



Item no.: 216-201

Ferrule; Sleeve for 0.5 mm² / 20 AWG; insulated; electro-tin plated; white

www.wago.com/216-201

Item no.: 216-202

Ferrule; Sleeve for 0.75 mm² / 18 AWG; insulated; electro-tin plated; gray

www.wago.com/216-202



Item no.: 216-203

Ferrule; Sleeve for 1 mm² / AWG 18; insulated; electro-tin plated; red

www.wago.com/216-203



Item no.: 216-204

Ferrule; Sleeve for 1.5 mm² / AWG 16; insulated; electro-tin plated; black

www.wago.com/216-204

Item no.: 216-301

Ferrule; Sleeve for 0.25 mm² / AWG 24; insulated; electro-tin plated; yellow

www.wago.com/216-301



Item no.: 216-302

Ferrule; Sleeve for 0.34 mm² / 22 AWG; insulated; electro-tin plated; green

www.wago.com/216-302

General accessories

Subject to changes. Please also observe the further product documentation!



Item no.: 231-162/003-000

Male connector for rail-mount terminal blocks; 1.2 x 1.2 mm pins; straight; Pin spacing 5 mm; 2-pole; gray

www.wago.com/231-162/003-000



Item no.: 231-163/003-000

Male connector for rail-mount terminal blocks; 1.2 x 1.2 mm pins; straight; Pin spacing 5 mm; 3-pole; gray

www.wago.com/231-163/003-000



Item no.: 231-164/003-000

Male connector for rail-mount terminal blocks; 1.2 x 1.2 mm pins; straight; Pin spacing 5 mm; 4-pole; gray

www.wago.com/231-164/003-000



Item no.: 231-165/003-000

Male connector for rail-mount terminal blocks; 1.2 x 1.2 mm pins; straight; Pin spacing 5 mm; 5-pole; gray

www.wago.com/231-165/003-000



Item no.: 231-166/003-000

Male connector for rail-mount terminal blocks; 1.2 x 1.2 mm pins; straight; Pin spacing 5 mm; 6-pole; gray

www.wago.com/231-166/003-000



Item no.: 231-167/003-000

Male connector for rail-mount terminal blocks; 1.2 x 1.2 mm pins; straight; Pin spacing 5 mm; 7-pole; gray

www.wago.com/231-167/003-000

Item no.: 231-168/003-000

Male connector for rail-mount terminal blocks; 1.2 x 1.2 mm pins; straight; Pin spacing 5 mm; 8-pole; gray

www.wago.com/231-168/003-000

Item no.: 231-169/003-000

Male connector for rail-mount terminal blocks; 1.2 x 1.2 mm pins; straight; Pin spacing 5 mm; 9-pole; gray

www.wago.com/231-169/003-000

Item no.: 231-170/003-000

Male connector for rail-mount terminal blocks; 1.2 x 1.2 mm pins; straight; Pin spacing 5 mm; 10-pole; gray

www.wago.com/231-170/003-000



Item no.: 231-171/003-000

Male connector for rail-mount terminal blocks; 1.2 x 1.2 mm pins; straight; Pin spacing 5 mm; 11-pole; gray

www.wago.com/231-171/003-000



Item no.: 231-172/003-000

Male connector for rail-mount terminal blocks; 1.2 x 1.2 mm pins; straight; Pin spacing 5 mm; 12-pole; gray

www.wago.com/231-172/003-000



Item no.: 231-176/003-000

Male connector for rail-mount terminal blocks; 1.2 x 1.2 mm pins; straight; Pin spacing 5 mm; 16-pole; gray

www.wago.com/231-176/003-000



Item no.: 231-180/003-000

Male connector for rail-mount terminal blocks; 1.2 x 1.2 mm pins; straight; Pin spacing 5 mm; 20-pole; gray

www.wago.com/231-180/003-000

Item no.: 231-668

Subject to changes. Please also observe the further product documentation!

WAGO Kontakttechnik GmbH & Co. KG

Hansastr. 27

32423 Minden

Phone: +49571 887-0 | Fax: +49571 887-169

Email: info.de@wago.com | Web: www.wago.com

Do you have any questions about our products?

We are always happy to take your call at +49 (571) 887-44222.

Lockout caps; for covering unused clamping units; gray

www.wago.com/231-668**Item no.: 231-669**

Lockout caps; for covering unused clamping units; orange

www.wago.com/231-669**Item no.: 721-162/003-000**

Male connector for rail-mount terminal blocks; 1.2 x 1.2 mm pins; straight; 100% protected against mismatching; Pin spacing 5 mm; 2-pole; light gray

www.wago.com/721-162/003-000**Item no.: 721-163/003-000**

Male connector for rail-mount terminal blocks; 1.2 x 1.2 mm pins; straight; 100% protected against mismatching; Pin spacing 5 mm; 3-pole; light gray

www.wago.com/721-163/003-000**Item no.: 721-164/003-000**

Male connector for rail-mount terminal blocks; 1.2 x 1.2 mm pins; straight; 100% protected against mismatching; Pin spacing 5 mm; 4-pole; light gray

www.wago.com/721-164/003-000**Item no.: 721-165/003-000**

Male connector for rail-mount terminal blocks; 1.2 x 1.2 mm pins; straight; 100% protected against mismatching; Pin spacing 5 mm; 5-pole; light gray

www.wago.com/721-165/003-000**Item no.: 721-166/003-000**

Male connector for rail-mount terminal blocks; 1.2 x 1.2 mm pins; straight; 100% protected against mismatching; Pin spacing 5 mm; 6-pole; light gray

www.wago.com/721-166/003-000**Item no.: 721-167/003-000**

Male connector for rail-mount terminal blocks; 1.2 x 1.2 mm pins; straight; 100% protected against mismatching; Pin spacing 5 mm; 7-pole; light gray

www.wago.com/721-167/003-000**Item no.: 721-168/003-000**

Male connector for rail-mount terminal blocks; 1.2 x 1.2 mm pins; straight; 100% protected against mismatching; Pin spacing 5 mm; 8-pole; light gray

www.wago.com/721-168/003-000**Item no.: 721-169/003-000**

Male connector for rail-mount terminal blocks; 1.2 x 1.2 mm pins; straight; 100% protected against mismatching; Pin spacing 5 mm; 9-pole; light gray

www.wago.com/721-169/003-000**Item no.: 721-170/003-000**

Male connector for rail-mount terminal blocks; 1.2 x 1.2 mm pins; straight; 100% protected against mismatching; Pin spacing 5 mm; 10-pole; light gray

www.wago.com/721-170/003-000**Item no.: 721-171/003-000**

Male connector for rail-mount terminal blocks; 1.2 x 1.2 mm pins; straight; 100% protected against mismatching; Pin spacing 5 mm; 11-pole; light gray

www.wago.com/721-171/003-000**Item no.: 721-172/003-000**

Male connector for rail-mount terminal blocks; 1.2 x 1.2 mm pins; straight; 100% protected against mismatching; Pin spacing 5 mm; 12-pole; light gray

www.wago.com/721-172/003-000**Item no.: 721-173/003-000**

Male connector for rail-mount terminal blocks; 1.2 x 1.2 mm pins; straight; 100% protected against mismatching; Pin spacing 5 mm; 13-pole; light gray

www.wago.com/721-173/003-000

Subject to changes. Please also observe the further product documentation!

WAGO Kontakttechnik GmbH & Co. KG

Hansastr. 27

32423 Minden

Phone: +49571 887-0 | Fax: +49571 887-169

Email: info.de@wago.com | Web: www.wago.com

Do you have any questions about our products?



We are always happy to take your call at +49 (571) 887-44222.

Item no.: 721-174/003-000 Male connector for rail-mount terminal blocks; 1.2 x 1.2 mm pins; straight; 100% protected against mismatching; Pin spacing 5 mm; 14-pole; light gray	www.wago.com/721-174/003-000
Item no.: 721-175/003-000 Male connector for rail-mount terminal blocks; 1.2 x 1.2 mm pins; straight; 100% protected against mismatching; Pin spacing 5 mm; 15-pole; light gray	www.wago.com/721-175/003-000
Item no.: 721-176/003-000 Male connector for rail-mount terminal blocks; 1.2 x 1.2 mm pins; straight; 100% protected against mismatching; Pin spacing 5 mm; 16-pole; light gray	www.wago.com/721-176/003-000
Item no.: 721-180/003-000 Male connector for rail-mount terminal blocks; 1.2 x 1.2 mm pins; straight; 100% protected against mismatching; Pin spacing 5 mm; 20-pole; light gray	www.wago.com/721-180/003-000





Test Accessories

 Item no.: 249-141 L-type test plug module; modular; with spring-loaded contact pin; Center module; 1,50 mm ² ; gray	www.wago.com/249-141
---------------------------------------------------------------------------------------------------------------------------------------------------------------------------------------------------------------------------	----------------------------------------------------------------













Insulation stop

 Item no.: 280-470 Insulation stop; 0.08 - 0.2 mm ² "s" (0.14 mm ² "f-st"); 5 pieces/strip; white	www.wago.com/280-470
 Item no.: 280-471 Insulation stop; 0.25 - 0.5 mm ² ; 5 pieces/strip; light gray	www.wago.com/280-471
 Item no.: 280-472 Insulation stop; 0.75 - 1 mm ² ; 5 pieces/strip	www.wago.com/280-472

Carrier rail

Item no.: 210-112 Steel carrier rail; 35 x 7.5 mm; 1 mm thick; 2 m long; slotted; according to EN 60715; "Hole width 25 mm	www.wago.com/210-112
 Item no.: 210-113 Steel carrier rail; 35 x 7.5 mm; 1 mm thick; 2 m long; unslotted; according to EN 60715	www.wago.com/210-113
Item no.: 210-114 Steel carrier rail; 35 x 15 mm; 1.5 mm thick; 2 m long; unslotted; similar to EN 60715	www.wago.com/210-114
 Item no.: 210-115 Steel carrier rail; 35 x 7.5 mm; 1 mm thick; 2 m long; slotted; according to EN 60715; "Hole width 18 mm	www.wago.com/210-115
 Item no.: 210-118 Steel carrier rail; 35 x 15 mm; 2.3 mm thick; 2 m long; unslotted; according to EN 60715	www.wago.com/210-118
Item no.: 210-196 Aluminum carrier rail; 35 x 8.2 mm; 1.6 mm thick; 2 m long; unslotted; similar to EN 60715; silver-colored	www.wago.com/210-196
 Item no.: 210-197 Steel carrier rail; 35 x 15 mm; 1.5 mm thick; 2 m long; slotted; similar to EN 60715	www.wago.com/210-197

Subject to changes. Please also observe the further product documentation!

	Item no.: 210-198 Copper carrier rail; 35 x 15 mm; 2.3 mm thick; 2 m long; unslotted; according to EN 60715; copper-colored	www.wago.com/210-198
	Item no.: 210-504 Steel carrier rail; 35 x 7.5 mm; 1 mm thick; 2 m long; slotted; galvanized; according to EN 60715	www.wago.com/210-504
	Item no.: 210-505 Steel carrier rail; 35 x 7.5 mm; 1 mm thick; 2 m long; unslotted; galvanized; according to EN 60715	www.wago.com/210-505
	Item no.: 210-506 Steel carrier rail; 35 x 15 mm; 1.5 mm thick; 2 m long; unslotted; galvanized; similar to EN 60715	www.wago.com/210-506
	Item no.: 210-508 Steel carrier rail; 35 x 15 mm; 1.5 mm thick; 2 m long; slotted; galvanized; similar to EN 60715	www.wago.com/210-508
End plate		
	Item no.: 280-340 End and intermediate plate; 2.5 mm thick; gray	www.wago.com/280-340
	Item no.: 280-341 End and intermediate plate; 2.5 mm thick; orange	www.wago.com/280-341
	Item no.: 280-366 Intermediate plate; 1.1 mm thick; orange	www.wago.com/280-366
Female plug		
	Item no.: 232-132/005-000 Female connector for rail-mount terminal blocks; 0.6 x 1 mm pins; straight; Pin spacing 5 mm; 2-pole; gray	www.wago.com/232-132/005-000
	Item no.: 232-132/005-000/039-000 Female connector for rail-mount terminal blocks; 0.6 x 1 mm pins; straight; Locking lever; Pin spacing 5 mm; 2-pole; gray	www.wago.com/232-132/005-000/039-000
	Item no.: 232-133/005-000 Female connector for rail-mount terminal blocks; 0.6 x 1 mm pins; straight; Pin spacing 5 mm; 3-pole; gray	www.wago.com/232-133/005-000
	Item no.: 232-133/005-000/039-000 Female connector for rail-mount terminal blocks; 0.6 x 1 mm pins; straight; Locking lever; Pin spacing 5 mm; 3-pole; gray	www.wago.com/232-133/005-000/039-000
	Item no.: 232-134/005-000 Female connector for rail-mount terminal blocks; 0.6 x 1 mm pins; straight; Pin spacing 5 mm; 4-pole; gray	www.wago.com/232-134/005-000
	Item no.: 232-134/005-000/039-000 Female connector for rail-mount terminal blocks; 0.6 x 1 mm pins; straight; Locking lever; Pin spacing 5 mm; 4-pole; gray	www.wago.com/232-134/005-000/039-000
	Item no.: 232-135/005-000 Female connector for rail-mount terminal blocks; 0.6 x 1 mm pins; straight; Pin spacing 5 mm; 5-pole; gray	www.wago.com/232-135/005-000

Subject to changes. Please also observe the further product documentation!

gray

**Item no.: 232-135/005-000/039-000**

Female connector for rail-mount terminal blocks; 0.6 x 1 mm pins; straight; Locking lever; Pin spacing 5 mm; 5-pole; gray

www.wago.com/232-135/005-000/039-000**Item no.: 232-136/005-000**

Female connector for rail-mount terminal blocks; 0.6 x 1 mm pins; straight; Pin spacing 5 mm; 6-pole; gray

www.wago.com/232-136/005-000**Item no.: 232-136/005-000/039-000**

Female connector for rail-mount terminal blocks; 0.6 x 1 mm pins; straight; Locking lever; Pin spacing 5 mm; 6-pole; gray

www.wago.com/232-136/005-000/039-000**Item no.: 232-137/005-000**

Female connector for rail-mount terminal blocks; 0.6 x 1 mm pins; straight; Pin spacing 5 mm; 7-pole; gray

www.wago.com/232-137/005-000**Item no.: 232-137/005-000/039-000**

Female connector for rail-mount terminal blocks; 0.6 x 1 mm pins; straight; Locking lever; Pin spacing 5 mm; 7-pole; gray

www.wago.com/232-137/005-000/039-000**Item no.: 232-138/005-000**

Female connector for rail-mount terminal blocks; 0.6 x 1 mm pins; straight; Pin spacing 5 mm; 8-pole; gray

www.wago.com/232-138/005-000**Item no.: 232-138/005-000/039-000**

Female connector for rail-mount terminal blocks; 0.6 x 1 mm pins; straight; Locking lever; Pin spacing 5 mm; 8-pole; gray

www.wago.com/232-138/005-000/039-000**Item no.: 232-139/005-000**

Female connector for rail-mount terminal blocks; 0.6 x 1 mm pins; straight; Pin spacing 5 mm; 9-pole; gray

www.wago.com/232-139/005-000**Item no.: 232-139/005-000/039-000**

Female connector for rail-mount terminal blocks; 0.6 x 1 mm pins; straight; Locking lever; Pin spacing 5 mm; 9-pole; gray

www.wago.com/232-139/005-000/039-000**Item no.: 232-140/005-000**

Female connector for rail-mount terminal blocks; 0.6 x 1 mm pins; straight; Pin spacing 5 mm; 10-pole; gray

www.wago.com/232-140/005-000**Item no.: 232-140/005-000/039-000**

Female connector for rail-mount terminal blocks; 0.6 x 1 mm pins; straight; Locking lever; Pin spacing 5 mm; 10-pole; gray

www.wago.com/232-140/005-000/039-000**Item no.: 232-142/005-000**

Female connector for rail-mount terminal blocks; 0.6 x 1 mm pins; straight; Pin spacing 5 mm; 12-pole; gray

www.wago.com/232-142/005-000**Item no.: 232-142/005-000/039-000**

Female connector for rail-mount terminal blocks; 0.6 x 1 mm pins; straight; Locking lever; Pin spacing 5 mm; 12-pole; gray

www.wago.com/232-142/005-000/039-000

Subject to changes. Please also observe the further product documentation!

WAGO Kontakttechnik GmbH & Co. KG

Hansastr. 27









32423 Minden

Phone: +49571 887-0 | Fax: +49571 887-169

Email: info.de@wago.com | Web: www.wago.com

Do you have any questions about our products?

We are always happy to take your call at +49 (571) 887-44222.

	<p>Item no.: 232-146/005-000 Female connector for rail-mount terminal blocks; 0.6 x 1 mm pins; straight; Pin spacing 5 mm; 16-pole; gray</p>	<p>www.wago.com/232-146/005-000</p>
	<p>Item no.: 232-146/005-000/039-000 Female connector for rail-mount terminal blocks; 0.6 x 1 mm pins; straight; Locking lever; Pin spacing 5 mm; 16-pole; gray</p>	<p>www.wago.com/232-146/005-000/039-000</p>
	<p>Item no.: 232-147/005-000/039-000 Female connector for rail-mount terminal blocks; 0.6 x 1 mm pins; straight; Locking lever; Pin spacing 5 mm; 17-pole; gray</p>	<p>www.wago.com/232-147/005-000/039-000</p>
	<p>Item no.: 232-150/005-000 Female connector for rail-mount terminal blocks; 0.6 x 1 mm pins; straight; Pin spacing 5 mm; 20-pole; gray</p>	<p>www.wago.com/232-150/005-000</p>
	<p>Item no.: 232-150/005-000/039-000 Female connector for rail-mount terminal blocks; 0.6 x 1 mm pins; straight; Locking lever; Pin spacing 5 mm; 20-pole; gray</p>	<p>www.wago.com/232-150/005-000/039-000</p>
	<p>Item no.: 232-232/005-000 Female connector for rail-mount terminal blocks; 0.6 x 1 mm pins; angled; Pin spacing 5 mm; 2-pole; gray</p>	<p>www.wago.com/232-232/005-000</p>
	<p>Item no.: 232-232/005-000/039-000 Female connector for rail-mount terminal blocks; 0.6 x 1 mm pins; angled; Locking lever; Pin spacing 5 mm; 2-pole; gray</p>	<p>www.wago.com/232-232/005-000/039-000</p>
	<p>Item no.: 232-233/005-000 Female connector for rail-mount terminal blocks; 0.6 x 1 mm pins; angled; Pin spacing 5 mm; 3-pole; gray</p>	<p>www.wago.com/232-233/005-000</p>
	<p>Item no.: 232-233/005-000/039-000 Female connector for rail-mount terminal blocks; 0.6 x 1 mm pins; angled; Locking lever; Pin spacing 5 mm; 3-pole; gray</p>	<p>www.wago.com/232-233/005-000/039-000</p>
	<p>Item no.: 232-234/005-000 Female connector for rail-mount terminal blocks; 0.6 x 1 mm pins; angled; Pin spacing 5 mm; 4-pole; gray</p>	<p>www.wago.com/232-234/005-000</p>
	<p>Item no.: 232-234/005-000/039-000 Female connector for rail-mount terminal blocks; 0.6 x 1 mm pins; angled; Locking lever; Pin spacing 5 mm; 4-pole; gray</p>	<p>www.wago.com/232-234/005-000/039-000</p>
	<p>Item no.: 232-235/005-000 Female connector for rail-mount terminal blocks; 0.6 x 1 mm pins; angled; Pin spacing 5 mm; 5-pole; gray</p>	<p>www.wago.com/232-235/005-000</p>
	<p>Item no.: 232-235/005-000/039-000 Female connector for rail-mount terminal blocks; 0.6 x 1 mm pins; angled; Locking lever; Pin spacing 5 mm; 5-pole; gray</p>	<p>www.wago.com/232-235/005-000/039-000</p>

Item no.: 232-236/005-000

Subject to changes. Please also observe the further product documentation!



Female connector for rail-mount terminal blocks; 0.6 x 1 mm pins; angled; Pin spacing 5 mm; 6-pole; gray

www.wago.com/232-236/005-000



Item no.: 232-236/005-000/039-000

Female connector for rail-mount terminal blocks; 0.6 x 1 mm pins; angled; Locking lever; Pin spacing 5 mm; 6-pole; gray

www.wago.com/232-236/005-000/039-000



Item no.: 232-237/005-000

Female connector for rail-mount terminal blocks; 0.6 x 1 mm pins; angled; Pin spacing 5 mm; 7-pole; gray

www.wago.com/232-237/005-000

Item no.: 232-238/005-000

Female connector for rail-mount terminal blocks; 0.6 x 1 mm pins; angled; Pin spacing 5 mm; 8-pole; gray

www.wago.com/232-238/005-000

Item no.: 232-239/005-000

Female connector for rail-mount terminal blocks; 0.6 x 1 mm pins; angled; Pin spacing 5 mm; 9-pole; gray

www.wago.com/232-239/005-000



Item no.: 232-240/005-000

Female connector for rail-mount terminal blocks; 0.6 x 1 mm pins; angled; Pin spacing 5 mm; 10-pole; gray

www.wago.com/232-240/005-000



Item no.: 232-240/005-000/039-000

Female connector for rail-mount terminal blocks; 0.6 x 1 mm pins; angled; Locking lever; Pin spacing 5 mm; 10-pole; gray

www.wago.com/232-240/005-000/039-000



Item no.: 232-242/005-000

Female connector for rail-mount terminal blocks; 0.6 x 1 mm pins; angled; Pin spacing 5 mm; 12-pole; gray

www.wago.com/232-242/005-000



Item no.: 232-242/005-000/039-000

Female connector for rail-mount terminal blocks; 0.6 x 1 mm pins; angled; Locking lever; Pin spacing 5 mm; 12-pole; gray

www.wago.com/232-242/005-000/039-000

Item no.: 232-246/005-000

Female connector for rail-mount terminal blocks; 0.6 x 1 mm pins; angled; Pin spacing 5 mm; 16-pole; gray

www.wago.com/232-246/005-000

Item no.: 232-246/005-000/039-000

Female connector for rail-mount terminal blocks; 0.6 x 1 mm pins; angled; Locking lever; Pin spacing 5 mm; 16-pole; gray

www.wago.com/232-246/005-000/039-000

Item no.: 232-250/005-000

Female connector for rail-mount terminal blocks; 0.6 x 1 mm pins; angled; Pin spacing 5 mm; 20-pole; gray











www.wago.com/232-250/005-000

Item no.: 232-250/005-000/039-000













Female connector for rail-mount terminal blocks; 0.6 x 1 mm pins; angled; Locking lever; Pin spacing 5 mm; 20-pole; gray

www.wago.com/232-250/005-000/039-000













Subject to changes. Please also observe the further product documentation!

	Item no.: 232-732/005-000 THT female header; 0.6 x 1.0 mm solder pin; gray	www.wago.com/232-732/005-000
	Item no.: 232-733/005-000 THT female header; 0.6 x 1.0 mm solder pin; gray	www.wago.com/232-733/005-000
	Item no.: 232-734/005-000 THT female header; 0.6 x 1.0 mm solder pin; gray	www.wago.com/232-734/005-000
	Item no.: 232-734/005-000/039-000 THT female header; 0.6 x 1.0 mm solder pin; gray	www.wago.com/232-734/005-000/039-000
	Item no.: 232-735/005-000 THT female header; 0.6 x 1.0 mm solder pin; gray	www.wago.com/232-735/005-000
	Item no.: 232-735/005-000/039-000 THT female header; 0.6 x 1.0 mm solder pin; gray	www.wago.com/232-735/005-000/039-000
	Item no.: 232-736/005-000 THT female header; 0.6 x 1.0 mm solder pin; gray	www.wago.com/232-736/005-000
	Item no.: 232-736/005-000/039-000 THT female header; 0.6 x 1.0 mm solder pin; gray	www.wago.com/232-736/005-000/039-000
	Item no.: 232-738/005-000 THT female header; 0.6 x 1.0 mm solder pin; gray	www.wago.com/232-738/005-000
	Item no.: 232-740/005-000 THT female header; 0.6 x 1.0 mm solder pin; gray	www.wago.com/232-740/005-000
	Item no.: 232-742/005-000 THT female header; 0.6 x 1.0 mm solder pin; gray	www.wago.com/232-742/005-000
	Item no.: 232-832/005-000 THT female header; 0.6 x 1.0 mm solder pin; angled; Pin spacing 7.5 mm; 2-pole; gray	www.wago.com/232-832/005-000
	Item no.: 232-833/005-000 THT female header; 0.6 x 1.0 mm solder pin; angled; Pin spacing 7.5 mm; 3-pole; gray	www.wago.com/232-833/005-000

Subject to changes. Please also observe the further product documentation!













	Item no.: 232-834/005-000 THT female header; 0.6 x 1.0 mm solder pin; angled; Pin spacing 7.5 mm; 4-pole; gray	www.wago.com/232-834/005-000
	Item no.: 232-836/005-000 THT female header; 0.6 x 1.0 mm solder pin; angled; Pin spacing 7.5 mm; 6-pole; gray	www.wago.com/232-836/005-000
	Item no.: 232-836/005-000/039-000 THT female header; 0.6 x 1.0 mm solder pin; angled; Locking lever; Pin spacing 7.5 mm; 6-pole; gray	www.wago.com/232-836/005-000/039-000
	Item no.: 232-840/005-000 THT female header; 0.6 x 1.0 mm solder pin; angled; Pin spacing 7.5 mm; 10-pole; gray	www.wago.com/232-840/005-000
	Item no.: 232-842/005-000 THT female header; 0.6 x 1.0 mm solder pin; angled; Pin spacing 7.5 mm; 12-pole; gray	www.wago.com/232-842/005-000
	Item no.: 722-132/005-000 Female connector for rail-mount terminal blocks; 0.6 x 1 mm pins; straight; 100% protected against mismatching; Pin spacing 5 mm; 2-pole; light gray	www.wago.com/722-132/005-000
	Item no.: 722-132/005-000/039-000 Female connector for rail-mount terminal blocks; 0.6 x 1 mm pins; straight; 100% protected against mismatching; Locking lever; Pin spacing 5 mm; 2-pole; light gray	www.wago.com/722-132/005-000/039-000
	Item no.: 722-133/005-000 Female connector for rail-mount terminal blocks; 0.6 x 1 mm pins; straight; 100% protected against mismatching; Pin spacing 5 mm; 3-pole; light gray	www.wago.com/722-133/005-000
	Item no.: 722-133/005-000/039-000 Female connector for rail-mount terminal blocks; 0.6 x 1 mm pins; straight; 100% protected against mismatching; Locking lever; Pin spacing 5 mm; 3-pole; light gray	www.wago.com/722-133/005-000/039-000
	Item no.: 722-134/005-000 Female connector for rail-mount terminal blocks; 0.6 x 1 mm pins; straight; 100% protected against mismatching; Pin spacing 5 mm; 4-pole; light gray	www.wago.com/722-134/005-000
	Item no.: 722-134/005-000/039-000 Female connector for rail-mount terminal blocks; 0.6 x 1 mm pins; straight; 100% protected against mismatching; Locking lever; Pin spacing 5 mm; 4-pole; light gray	www.wago.com/722-134/005-000/039-000
	Item no.: 722-135/005-000 Female connector for rail-mount terminal blocks; 0.6 x 1 mm pins; straight; 100% protected against mismatching; Pin spacing 5 mm; 5-pole; light gray	www.wago.com/722-135/005-000
	Item no.: 722-135/005-000/039-000 Female connector for rail-mount terminal blocks; 0.6 x 1 mm pins; straight; 100% protected against mismatching; Locking lever; Pin spacing 5 mm; 5-pole; light gray	www.wago.com/722-135/005-000/039-000
	Item no.: 722-136/005-000	

Subject to changes. Please also observe the further product documentation!

	Female connector for rail-mount terminal blocks; 0.6 x 1 mm pins; straight; 100% protected against mismatching; Pin spacing 5 mm; 6-pole; light gray	www.wago.com/722-136/005-000
	Item no.: 722-136/005-000/039-000 Female connector for rail-mount terminal blocks; 0.6 x 1 mm pins; straight; 100% protected against mismatching; Locking lever; Pin spacing 5 mm; 6-pole; light gray	www.wago.com/722-136/005-000/039-000
	Item no.: 722-137/005-000 Female connector for rail-mount terminal blocks; 0.6 x 1 mm pins; straight; 100% protected against mismatching; Pin spacing 5 mm; 7-pole; light gray	www.wago.com/722-137/005-000
	Item no.: 722-137/005-000/039-000 Female connector for rail-mount terminal blocks; 0.6 x 1 mm pins; straight; 100% protected against mismatching; Locking lever; Pin spacing 5 mm; 7-pole; light gray	www.wago.com/722-137/005-000/039-000
	Item no.: 722-138/005-000 Female connector for rail-mount terminal blocks; 0.6 x 1 mm pins; straight; 100% protected against mismatching; Pin spacing 5 mm; 8-pole; light gray	www.wago.com/722-138/005-000
	Item no.: 722-138/005-000/039-000 Female connector for rail-mount terminal blocks; 0.6 x 1 mm pins; straight; 100% protected against mismatching; Locking lever; Pin spacing 5 mm; 8-pole; light gray	www.wago.com/722-138/005-000/039-000
	Item no.: 722-139/005-000 Female connector for rail-mount terminal blocks; 0.6 x 1 mm pins; straight; 100% protected against mismatching; Pin spacing 5 mm; 9-pole; light gray	www.wago.com/722-139/005-000
	Item no.: 722-139/005-000/039-000 Female connector for rail-mount terminal blocks; 0.6 x 1 mm pins; straight; 100% protected against mismatching; Locking lever; Pin spacing 5 mm; 9-pole; light gray	www.wago.com/722-139/005-000/039-000
	Item no.: 722-140/005-000 Female connector for rail-mount terminal blocks; 0.6 x 1 mm pins; straight; 100% protected against mismatching; Pin spacing 5 mm; 10-pole; light gray	www.wago.com/722-140/005-000
	Item no.: 722-140/005-000/039-000 Female connector for rail-mount terminal blocks; 0.6 x 1 mm pins; straight; 100% protected against mismatching; Locking lever; Pin spacing 5 mm; 10-pole; light gray	www.wago.com/722-140/005-000/039-000
	Item no.: 722-141/005-000 Female connector for rail-mount terminal blocks; 0.6 x 1 mm pins; straight; 100% protected against mismatching; Pin spacing 5 mm; 11-pole; light gray	www.wago.com/722-141/005-000
	Item no.: 722-142/005-000 Female connector for rail-mount terminal blocks; 0.6 x 1 mm pins; straight; 100% protected against mismatching; Pin spacing 5 mm; 12-pole; light gray	www.wago.com/722-142/005-000
	Item no.: 722-142/005-007/039-000 Female connector for rail-mount terminal blocks; gray	www.wago.com/722-142/005-007/039-000

Item no.: 722-143/005-000

Subject to changes. Please also observe the further product documentation!

	Female connector for rail-mount terminal blocks; 0.6 x 1 mm pins; straight; 100% protected against mismatching; Pin spacing 5 mm; 13-pole; light gray	www.wago.com/722-143/005-000
	Item no.: 722-144/005-000 Female connector for rail-mount terminal blocks; 0.6 x 1 mm pins; straight; 100% protected against mismatching; Pin spacing 5 mm; 14-pole; light gray	www.wago.com/722-144/005-000
	Item no.: 722-144/005-000/039-000 Female connector for rail-mount terminal blocks; 0.6 x 1 mm pins; straight; 100% protected against mismatching; Locking lever; Pin spacing 5 mm; 14-pole; light gray	www.wago.com/722-144/005-000/039-000
	Item no.: 722-145/005-000 Female connector for rail-mount terminal blocks; 0.6 x 1 mm pins; straight; 100% protected against mismatching; Pin spacing 5 mm; 15-pole; light gray	www.wago.com/722-145/005-000
	Item no.: 722-146/005-000 Female connector for rail-mount terminal blocks; 0.6 x 1 mm pins; straight; 100% protected against mismatching; Pin spacing 5 mm; 16-pole; light gray	www.wago.com/722-146/005-000
	Item no.: 722-146/005-000/039-000 Female connector for rail-mount terminal blocks; 0.6 x 1 mm pins; straight; 100% protected against mismatching; Locking lever; Pin spacing 5 mm; 16-pole; light gray	www.wago.com/722-146/005-000/039-000
	Item no.: 722-150/005-000 Female connector for rail-mount terminal blocks; 0.6 x 1 mm pins; straight; 100% protected against mismatching; Pin spacing 5 mm; 20-pole; light gray	www.wago.com/722-150/005-000
	Item no.: 722-150/005-000/039-000 Female connector for rail-mount terminal blocks; 0.6 x 1 mm pins; straight; 100% protected against mismatching; Locking lever; Pin spacing 5 mm; 20-pole; light gray	www.wago.com/722-150/005-000/039-000
	Item no.: 722-232/005-000 Female connector for rail-mount terminal blocks; 0.6 x 1 mm pins; angled; 100% protected against mismatching; Pin spacing 5 mm; 2-pole; light gray	www.wago.com/722-232/005-000
	Item no.: 722-232/005-000/039-000 Female connector for rail-mount terminal blocks; 0.6 x 1 mm pins; angled; 100% protected against mismatching; Locking lever; Pin spacing 5 mm; 2-pole; light gray	www.wago.com/722-232/005-000/039-000
	Item no.: 722-233/005-000 Female connector for rail-mount terminal blocks; 0.6 x 1 mm pins; angled; 100% protected against mismatching; Pin spacing 5 mm; 3-pole; light gray	www.wago.com/722-233/005-000
	Item no.: 722-233/005-000/039-000 Female connector for rail-mount terminal blocks; 0.6 x 1 mm pins; angled; 100% protected against mismatching; Locking lever; Pin spacing 5 mm; 3-pole; light gray	www.wago.com/722-233/005-000/039-000
	Item no.: 722-234/005-000 Female connector for rail-mount terminal blocks; 0.6 x 1 mm pins; angled; 100% protected against mismatching; Pin spacing 5 mm; 4-pole; light gray	www.wago.com/722-234/005-000
	Item no.: 722-234/005-000/039-000	

Subject to changes. Please also observe the further product documentation!



Female connector for rail-mount terminal blocks; 0.6 x 1 mm pins; angled; 100% protected against mismatching; Locking lever; Pin spacing 5 mm; 4-pole; light gray

www.wago.com/722-234/005-000/039-000



Item no.: 722-235/005-000

Female connector for rail-mount terminal blocks; 0.6 x 1 mm pins; angled; 100% protected against mismatching; Pin spacing 5 mm; 5-pole; light gray

www.wago.com/722-235/005-000



Item no.: 722-235/005-000/039-000

Female connector for rail-mount terminal blocks; 0.6 x 1 mm pins; angled; 100% protected against mismatching; Locking lever; Pin spacing 5 mm; 5-pole; light gray

www.wago.com/722-235/005-000/039-000



Item no.: 722-236/005-000

Female connector for rail-mount terminal blocks; 0.6 x 1 mm pins; angled; 100% protected against mismatching; Pin spacing 5 mm; 6-pole; light gray

www.wago.com/722-236/005-000



Item no.: 722-236/005-000/039-000

Female connector for rail-mount terminal blocks; 0.6 x 1 mm pins; angled; 100% protected against mismatching; Locking lever; Pin spacing 5 mm; 6-pole; light gray

www.wago.com/722-236/005-000/039-000



Item no.: 722-237/005-000

Female connector for rail-mount terminal blocks; 0.6 x 1 mm pins; angled; 100% protected against mismatching; Pin spacing 5 mm; 7-pole; light gray

www.wago.com/722-237/005-000



Item no.: 722-237/005-000/039-000

Female connector for rail-mount terminal blocks; 0.6 x 1 mm pins; angled; 100% protected against mismatching; Locking lever; Pin spacing 5 mm; 7-pole; light gray

www.wago.com/722-237/005-000/039-000



Item no.: 722-238/005-000

Female connector for rail-mount terminal blocks; 0.6 x 1 mm pins; angled; 100% protected against mismatching; Pin spacing 5 mm; 8-pole; light gray

www.wago.com/722-238/005-000



Item no.: 722-239/005-000

Female connector for rail-mount terminal blocks; 0.6 x 1 mm pins; angled; 100% protected against mismatching; Pin spacing 5 mm; 9-pole; light gray

www.wago.com/722-239/005-000



Item no.: 722-239/005-000/039-000

Female connector for rail-mount terminal blocks; 0.6 x 1 mm pins; angled; 100% protected against mismatching; Locking lever; Pin spacing 5 mm; 9-pole; light gray

www.wago.com/722-239/005-000/039-000



Item no.: 722-240/005-000

Female connector for rail-mount terminal blocks; 0.6 x 1 mm pins; angled; 100% protected against mismatching; Pin spacing 5 mm; 10-pole; light gray

www.wago.com/722-240/005-000



Item no.: 722-240/005-000/039-000

Female connector for rail-mount terminal blocks; 0.6 x 1 mm pins; angled; 100% protected against mismatching; Locking lever; Pin spacing 5 mm; 10-pole; light gray

www.wago.com/722-240/005-000/039-000



Item no.: 722-241/005-000

Female connector for rail-mount terminal blocks; 0.6 x 1 mm pins; angled; 100% protected against mismatching; Pin spacing 5 mm; 11-pole; light gray

www.wago.com/722-241/005-000

Item no.: 722-242/005-000

Subject to changes. Please also observe the further product documentation!

WAGO Kontakttechnik GmbH & Co. KG

Hansastr. 27

32423 Minden

Phone: +49571 887-0 | Fax: +49571 887-169

Email: info.de@wago.com | Web: www.wago.com

Do you have any questions about our products?

We are always happy to take your call at +49 (571) 887-44222.



Female connector for rail-mount terminal blocks; 0.6 x 1 mm pins; angled; 100% protected against mismatching; Pin spacing 5 mm; 12-pole; light gray

www.wago.com/722-242/005-000



Item no.: 722-242/005-000/039-000

Female connector for rail-mount terminal blocks; 0.6 x 1 mm pins; angled; 100% protected against mismatching; Locking lever; Pin spacing 5 mm; 12-pole; light gray

www.wago.com/722-242/005-000/039-000



Item no.: 722-243/005-000

Female connector for rail-mount terminal blocks; 0.6 x 1 mm pins; angled; 100% protected against mismatching; Pin spacing 5 mm; 13-pole; light gray

www.wago.com/722-243/005-000



Item no.: 722-244/005-000

Female connector for rail-mount terminal blocks; 0.6 x 1 mm pins; angled; 100% protected against mismatching; Pin spacing 5 mm; 14-pole; light gray

www.wago.com/722-244/005-000



Item no.: 722-244/005-000/039-000

Female connector for rail-mount terminal blocks; 0.6 x 1 mm pins; angled; 100% protected against mismatching; Locking lever; Pin spacing 5 mm; 14-pole; light gray

www.wago.com/722-244/005-000/039-000



Item no.: 722-246/005-000

Female connector for rail-mount terminal blocks; 0.6 x 1 mm pins; angled; 100% protected against mismatching; Pin spacing 5 mm; 16-pole; light gray

www.wago.com/722-246/005-000



Item no.: 722-246/005-000/039-000

Female connector for rail-mount terminal blocks; 0.6 x 1 mm pins; angled; 100% protected against mismatching; Locking lever; Pin spacing 5 mm; 16-pole; light gray

www.wago.com/722-246/005-000/039-000



Item no.: 722-250/005-000

Female connector for rail-mount terminal blocks; 0.6 x 1 mm pins; angled; 100% protected against mismatching; Pin spacing 5 mm; 20-pole; light gray

www.wago.com/722-250/005-000

assembling

Item no.: 209-106

Mounting carrier; for isolated mounting on DIN 35 rails; gray

www.wago.com/209-106

Item no.: 709-154

Cover; Type 2; suitable for cover carrier, type 2; 1 m long; transparent

www.wago.com/709-154

tools



Item no.: 210-657

Operating tool; Blade: 3.5 x 0.5 mm; with a partially insulated shaft; short

www.wago.com/210-657

Item no.: 210-658

Operating tool; Blade: 3.5 x 0.5 mm; with a partially insulated shaft; angled; short

www.wago.com/210-658

Item no.: 210-720

Operating tool; Blade: 3.5 x 0.5 mm; with a partially insulated shaft

www.wago.com/210-720

Jumper



Item no.: 210-103

Wire commoning chain; insulated; 50 connections; black

www.wago.com/210-103

Subject to changes. Please also observe the further product documentation!

WAGO Kontakttechnik GmbH & Co. KG

Hansastr. 27













32423 Minden

Phone: +49571 887-0 | Fax: +49571 887-169

Email: info.de@wago.com | Web: www.wago.com

Do you have any questions about our products?

We are always happy to take your call at +49 (571) 887-44222.

	<p>Item no.: 210-123 Wire commoning chain; insulated; 50 connections</p>	www.wago.com/210-123
	<p>Item no.: 249-123 Push-in type wire jumper; insulated; wire length 180 mm; Conductor cross section 0.75 mm²</p>	www.wago.com/249-123
	<p>Item no.: 249-125 Push-in type wire jumper; insulated; wire length 60 mm; Conductor cross section 0.75 mm²</p>	www.wago.com/249-125
	<p>Item no.: 249-126 Push-in type wire jumper; insulated; wire length 110 mm; Conductor cross section 0.75 mm²</p>	www.wago.com/249-126
	<p>Item no.: 249-127 Push-in type wire jumper; insulated; wire length 250 mm; Conductor cross section 0.75 mm²</p>	www.wago.com/249-127
	<p>Item no.: 280-482 Comb-style jumper bar; insulated; 2-way; IN = IN terminal block; gray</p>	www.wago.com/280-482
	<p>Item no.: 280-483 Comb-style jumper bar; insulated; 3-way; IN = IN terminal block; gray</p>	www.wago.com/280-483
	<p>Item no.: 280-484 Comb-style jumper bar; insulated; 4-way; IN = IN terminal block; gray</p>	www.wago.com/280-484
	<p>Item no.: 280-485 Comb-style jumper bar; insulated; 5-way; IN = IN terminal block; gray</p>	www.wago.com/280-485
	<p>Item no.: 280-490 Comb-style jumper bar; insulated; 10-way; IN = IN terminal block; gray</p>	www.wago.com/280-490
	<p>Item no.: 280-492 Alternate comb-style jumper bar; insulated; 2-way; IN = IN terminal block; gray</p>	www.wago.com/280-492
	<p>Item no.: 709-110 Wire commoning chain; insulated; 4 connections; 3 x 110 mm; black</p>	www.wago.com/709-110
	<p>Item no.: 709-111 Wire commoning chain; insulated; 3 connections; 2 x 120 mm; black</p>	www.wago.com/709-111
	<p>Item no.: 709-112 Wire commoning chain; insulated; 3 connections; 2 x 170 mm; black</p>	www.wago.com/709-112
Protective Warning Marker		
	<p>Item no.: 280-415 Protective warning marker; with high-voltage symbol, black; for 5 terminal blocks; yellow</p>	www.wago.com/280-415

Downloads

Documentation

Additional Information

Technical explanations	Apr 3, 2019	pdf 2.1 MB	Download
------------------------	-------------	---------------	----------

Subject to changes. Please also observe the further product documentation!

CAD/CAE-Data

CAE data

EPLAN Data Portal 280-525	URL	Download
WSCAD Universe 280-525	URL	Download

Installation Notes

Assembly

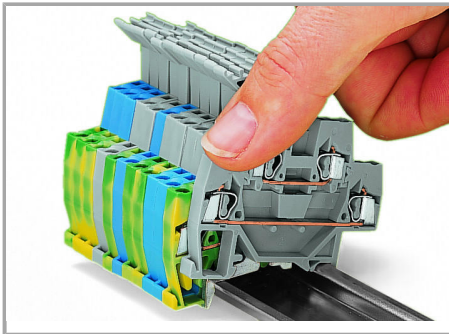

Snapping a terminal block onto the carrier rail.



Removing a terminal block from the assembly.

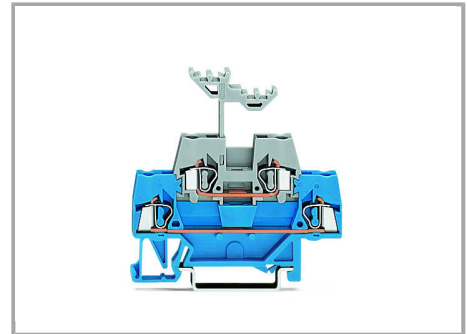

Double-deck terminal blocks accommodate two circuits of different potentials on two decks; different circuits can be differentiated by color coding either deck (280 Series). The lower deck is wider than the upper for ease of wiring.

Inserting a conductor

Subject to changes. Please also observe the further product documentation!

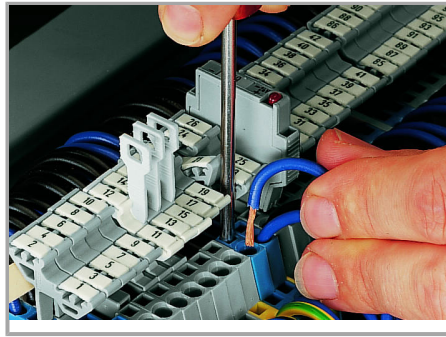
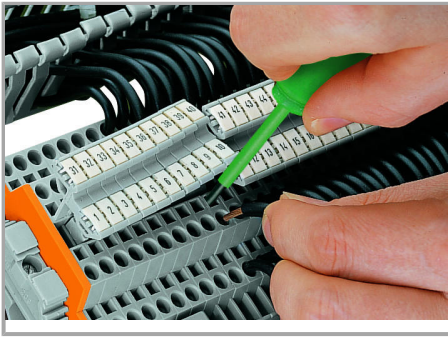

The flexible marker carrier, which is placed above the wiring level, can be pushed aside during wiring or commoning. The carrier has two staggered levels for WMB markers that perfectly align with the terminal block decks.

Jumpered



Commoning using an adjacent jumper (280-402).

Push jumper down until fully inserted.

Jumpered

Subject to changes. Please also observe the further product documentation!

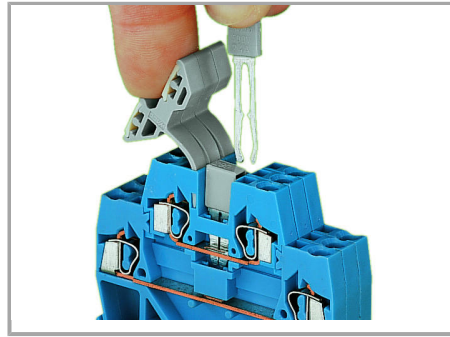
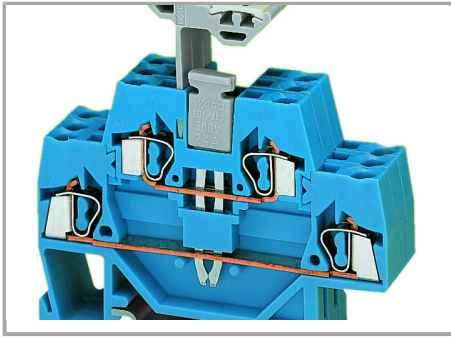

Commoning with a vertical jumper (281-421). Combining vertical and adjacent jumpers.

Push vertical jumper down until fully inserted.

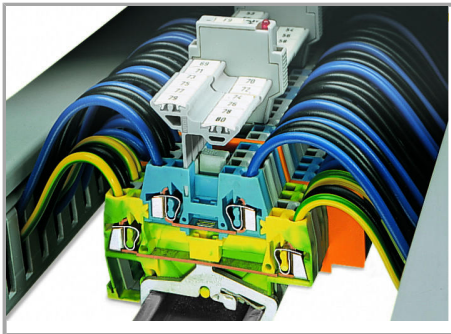

Example of a mixed assembly with double-deck terminal blocks.

The 280 Series Double-Deck Terminal Blocks are available with decks of same or different color according to their function. This is an additional visual aid during wiring, service or maintenance.

Subject to changes. Please also observe the further product documentation!

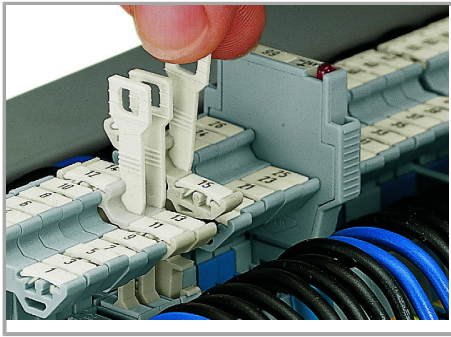

Pulling the disconnect tab.

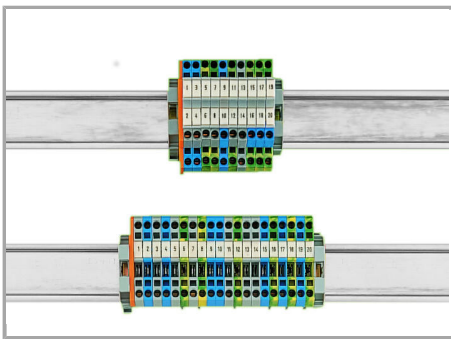

Save 50 % of rail space via double-deck terminal blocks.

Marking

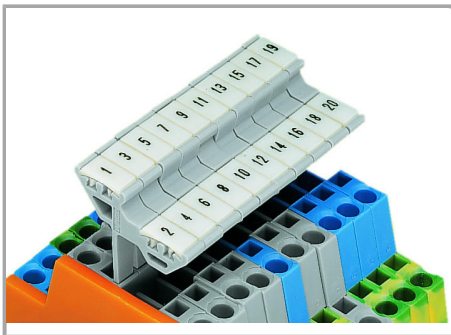

Labeling via WMB Multi Marking System.

Subject to changes. Please also observe the further product documentation!