

Data sheet | Item number: 279-809/281-434

Component terminal block; 4-conductor; LED (red); 24 VDC; for DIN-rail 35 x 15 and 35 x 7.5; 1.5 mm<sup>2</sup>; CAGE CLAMP®; 1,50 mm<sup>2</sup>; gray

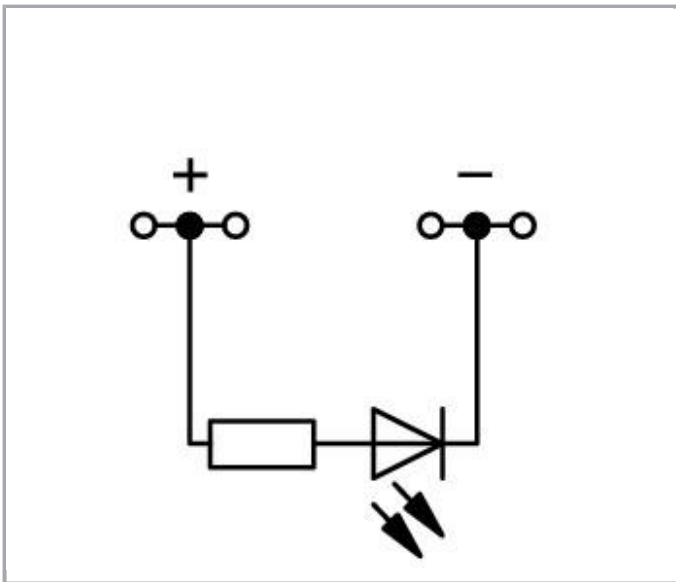

[www.wago.com/279-809/281-434](http://www.wago.com/279-809/281-434)

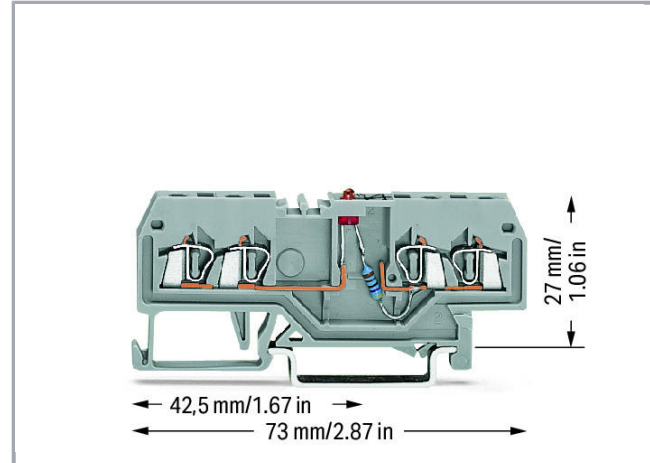
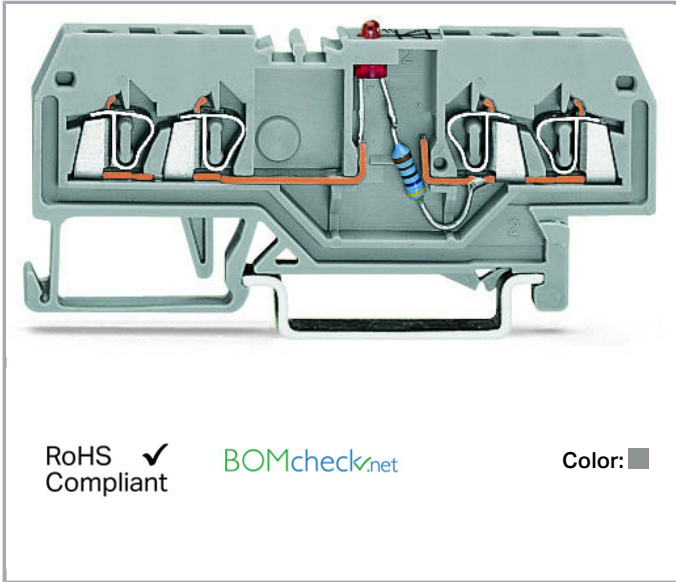

Data

Electrical data

Voltage type (1)	DC
Nominal voltage	24 V

Subject to changes. Please also observe the further product documentation!

WAGO Kontakttechnik GmbH & Co. KG  
Hansastr. 27  
32423 Minden  
Phone: +49571 887-0 | Fax: +49571 887-169  
Email: [info.de@wago.com](mailto:info.de@wago.com) | Web: [www.wago.com](http://www.wago.com)

Do you have any questions about our products?  
We are always happy to take your call at +49 (571) 887-44222.

## Ratings per IEC/EN 60664-1

Ratings per	IEC/EN 60947-7-1
Rated current	0.025 A

## Connection data

Connection technology	CAGE CLAMP®
Actuation type	Operating tool
Connectable conductor materials	Copper
Solid conductor	0.08 ... 1.5 mm <sup>2</sup> / 28 ... 16 AWG
Fine-stranded conductor	0.08 ... 1.5 mm <sup>2</sup> / 28 ... 16 AWG
Strip length	8 ... 9 mm / 0.31 ... 0.35 inch
Total number of connection points	4
Total number of potentials	1
Number of levels	1
Type of wiring	Front-entry wiring

## Geometrical Data

Width	4 mm / 0.157 inch
Height from upper-edge of DIN-35 rail	27 mm / 1.063 inch
Depth	73 mm / 2.874 inch

## Mechanical data

Design	horizontal
Type of mounting	DIN-35 rail
Marking level	Center marking

## Material Data

Color	gray
Insulating material	Polyamide 66 (PA 66)
Fire load	0.12 MJ
Weight	6.6 g

## Commercial data

Product Group	1 (Rail Mounted Terminal Blocks)
Packaging type	BOX

Subject to changes. Please also observe the further product documentation!

Country of origin	DE
GTIN	4045454194109
Customs Tariff No.	85369010000

## Counterpart

## Compatible products

### Protective Warning Marker

	<p><b>Item no.: 279-415</b> Protective warning marker; with high-voltage symbol, black; for 5 terminal blocks; yellow</p>	<a href="http://www.wago.com/279-415">www.wago.com/279-415</a>
--	---	--

### Jumper

	<p><b>Item no.: 210-103</b> Wire commoning chain; insulated; 50 connections; black</p>	<a href="http://www.wago.com/210-103">www.wago.com/210-103</a>
--	--	--

	<p><b>Item no.: 249-123</b> Push-in type wire jumper; insulated; wire length 180 mm; Conductor cross section 0.75 mm<sup>2</sup></p>	<a href="http://www.wago.com/249-123">www.wago.com/249-123</a>
--	--	--

	<p><b>Item no.: 249-125</b> Push-in type wire jumper; insulated; wire length 60 mm; Conductor cross section 0.75 mm<sup>2</sup></p>	<a href="http://www.wago.com/249-125">www.wago.com/249-125</a>
--	---	--

	<p><b>Item no.: 249-126</b> Push-in type wire jumper; insulated; wire length 110 mm; Conductor cross section 0.75 mm<sup>2</sup></p>	<a href="http://www.wago.com/249-126">www.wago.com/249-126</a>
--	--	--

	<p><b>Item no.: 249-127</b> Push-in type wire jumper; insulated; wire length 250 mm; Conductor cross section 0.75 mm<sup>2</sup></p>	<a href="http://www.wago.com/249-127">www.wago.com/249-127</a>
--	--	--

	<p><b>Item no.: 279-482</b> Comb-style jumper bar; insulated; 2-way; IN = IN terminal block; gray</p>	<a href="http://www.wago.com/279-482">www.wago.com/279-482</a>
--	---	--

	<p><b>Item no.: 279-483</b> Comb-style jumper bar; insulated; 3-way; IN = IN terminal block; gray</p>	<a href="http://www.wago.com/279-483">www.wago.com/279-483</a>
--	---	--

	<p><b>Item no.: 279-490</b> Comb-style jumper bar; insulated; 10-way; IN = IN terminal block; gray</p>	<a href="http://www.wago.com/279-490">www.wago.com/279-490</a>
--	--	--

	<p><b>Item no.: 279-492</b> Alternate comb-style jumper bar; insulated; 2-way; IN = IN terminal block; gray</p>	<a href="http://www.wago.com/279-492">www.wago.com/279-492</a>
--	---	--

### tools

Subject to changes. Please also observe the further product documentation!



**Item no.: 210-647**  
Operating tool; Blade: 2.5 x 0.4 mm; with a partially insulated shaft

[www.wago.com/210-647](http://www.wago.com/210-647)



**Item no.: 210-648**  
Operating tool; Blade: 2.5 x 0.4 mm; with a partially insulated shaft; angled; short

[www.wago.com/210-648](http://www.wago.com/210-648)



**Item no.: 210-719**  
Operating tool; Blade: 2.5 x 0.4 mm; with a partially insulated shaft

[www.wago.com/210-719](http://www.wago.com/210-719)

**End plate**



**Item no.: 279-344**  
End and intermediate plate; 2 mm thick; gray

[www.wago.com/279-344](http://www.wago.com/279-344)

**Item no.: 279-345**  
Separator plate; 2 mm thick; oversized; gray

[www.wago.com/279-345](http://www.wago.com/279-345)

**Item no.: 279-346**  
End and intermediate plate; 2 mm thick; orange

[www.wago.com/279-346](http://www.wago.com/279-346)



**Item no.: 279-347**  
Separator plate; 2 mm thick; oversized; orange

[www.wago.com/279-347](http://www.wago.com/279-347)

**Carrier rail**

**Item no.: 210-112**  
Steel carrier rail; 35 x 7.5 mm; 1 mm thick; 2 m long; slotted; according to EN 60715; "Hole width 25 mm

[www.wago.com/210-112](http://www.wago.com/210-112)

**Item no.: 210-113**  
Steel carrier rail; 35 x 7.5 mm; 1 mm thick; 2 m long; unslotted; according to EN 60715

[www.wago.com/210-113](http://www.wago.com/210-113)

**Item no.: 210-114**  
Steel carrier rail; 35 x 15 mm; 1.5 mm thick; 2 m long; unslotted; similar to EN 60715

[www.wago.com/210-114](http://www.wago.com/210-114)

**Item no.: 210-115**  
Steel carrier rail; 35 x 7.5 mm; 1 mm thick; 2 m long; slotted; according to EN 60715; "Hole width 18 mm

[www.wago.com/210-115](http://www.wago.com/210-115)

**Item no.: 210-118**  
Steel carrier rail; 35 x 15 mm; 2.3 mm thick; 2 m long; unslotted; according to EN 60715

[www.wago.com/210-118](http://www.wago.com/210-118)

**Item no.: 210-196**  
Aluminum carrier rail; 35 x 8.2 mm; 1.6 mm thick; 2 m long; unslotted; similar to EN 60715; silver-colored

[www.wago.com/210-196](http://www.wago.com/210-196)

**Item no.: 210-197**  
Steel carrier rail; 35 x 15 mm; 1.5 mm thick; 2 m long; slotted; similar to EN 60715

[www.wago.com/210-197](http://www.wago.com/210-197)

**Item no.: 210-198**  
Copper carrier rail; 35 x 15 mm; 2.3 mm thick; 2 m long; unslotted; according to EN 60715; copper-colored

[www.wago.com/210-198](http://www.wago.com/210-198)

**Item no.: 210-504**  
Steel carrier rail; 35 x 7.5 mm; 1 mm thick; 2 m long; slotted; galvanized; according to EN 60715

[www.wago.com/210-504](http://www.wago.com/210-504)

**Item no.: 210-505**  
Steel carrier rail; 35 x 7.5 mm; 1 mm thick; 2 m long; unslotted; galvanized; according to EN 60715

[www.wago.com/210-505](http://www.wago.com/210-505)

Subject to changes. Please also observe the further product documentation!

**Item no.: 210-506**  
Steel carrier rail; 35 x 15 mm; 1.5 mm thick; 2 m long; unslotted; galvanized; similar to EN 60715 [www.wago.com/210-506](http://www.wago.com/210-506)

**Item no.: 210-508**  
Steel carrier rail; 35 x 15 mm; 1.5 mm thick; 2 m long; slotted; galvanized; similar to EN 60715 [www.wago.com/210-508](http://www.wago.com/210-508)

**Marking accessories**

**Item no.: 2009-114**  
WMB-Inline; for Smart Printer; 2000 pieces on roll; stretchable 4 - 4.2 mm; plain; snap-on type; white [www.wago.com/2009-114](http://www.wago.com/2009-114)

 **Item no.: 2009-114/000-002**  
WMB-Inline; for Smart Printer; 2000 pieces on roll; stretchable 4 - 4.2 mm; plain; snap-on type; yellow [www.wago.com/2009-114/000-002](http://www.wago.com/2009-114/000-002)

**Item no.: 2009-114/000-005**  
WMB-Inline; for Smart Printer; 2000 pieces on roll; stretchable 4 - 4.2 mm; plain; snap-on type; red [www.wago.com/2009-114/000-005](http://www.wago.com/2009-114/000-005)

 **Item no.: 2009-114/000-006**  
WMB-Inline; for Smart Printer; 2000 pieces on roll; stretchable 4 - 4.2 mm; plain; snap-on type; blue [www.wago.com/2009-114/000-006](http://www.wago.com/2009-114/000-006)

 **Item no.: 2009-114/000-007**  
WMB-Inline; for Smart Printer; 2000 pieces on roll; stretchable 4 - 4.2 mm; plain; snap-on type; gray [www.wago.com/2009-114/000-007](http://www.wago.com/2009-114/000-007)

 **Item no.: 2009-114/000-012**  
WMB-Inline; for Smart Printer; 2000 pieces on roll; stretchable 4 - 4.2 mm; plain; snap-on type; orange [www.wago.com/2009-114/000-012](http://www.wago.com/2009-114/000-012)

 **Item no.: 2009-114/000-023**  
WMB-Inline; for Smart Printer; 2000 pieces on roll; stretchable 4 - 4.2 mm; plain; snap-on type; green [www.wago.com/2009-114/000-023](http://www.wago.com/2009-114/000-023)

 **Item no.: 2009-114/000-024**  
WMB-Inline; for Smart Printer; 2000 pieces on roll; stretchable 4 - 4.2 mm; plain; snap-on type; violet [www.wago.com/2009-114/000-024](http://www.wago.com/2009-114/000-024)







**Item no.: 249-105**  
Group marker carrier; gray [www.wago.com/249-105](http://www.wago.com/249-105)

 **Item no.: 793-4501**  
WMB marking card; as card; stretchable 4 - 4.2 mm; plain; snap-on type; white [www.wago.com/793-4501](http://www.wago.com/793-4501)



 **Item no.: 793-4501/000-002**  
WMB marking card; as card; stretchable 4 - 4.2 mm; plain; snap-on type; yellow [www.wago.com/793-4501/000-002](http://www.wago.com/793-4501/000-002)

 **Item no.: 793-4501/000-005**  
WMB marking card; as card; stretchable 4 - 4.2 mm; plain; snap-on type; red [www.wago.com/793-4501/000-005](http://www.wago.com/793-4501/000-005)

Subject to changes. Please also observe the further product documentation!

	<p><b>Item no.: 793-4501/000-006</b> WMB marking card; as card; stretchable 4 - 4.2 mm; plain; snap-on type; blue</p>	<a href="http://www.wago.com/793-4501/000-006">www.wago.com/793-4501/000-006</a>
	<p><b>Item no.: 793-4501/000-007</b> WMB marking card; as card; stretchable 4 - 4.2 mm; plain; snap-on type; gray</p>	<a href="http://www.wago.com/793-4501/000-007">www.wago.com/793-4501/000-007</a>
	<p><b>Item no.: 793-4501/000-012</b> WMB marking card; as card; stretchable 4 - 4.2 mm; plain; snap-on type; orange</p>	<a href="http://www.wago.com/793-4501/000-012">www.wago.com/793-4501/000-012</a>
	<p><b>Item no.: 793-4501/000-014</b> WMB marking card; as card; stretchable 4 - 4.2 mm; plain; snap-on type; brown</p>	<a href="http://www.wago.com/793-4501/000-014">www.wago.com/793-4501/000-014</a>
	<p><b>Item no.: 793-4501/000-017</b> WMB marking card; as card; stretchable 4 - 4.2 mm; plain; snap-on type; green</p>	<a href="http://www.wago.com/793-4501/000-017">www.wago.com/793-4501/000-017</a>
	<p><b>Item no.: 793-4501/000-023</b> WMB marking card; as card; stretchable 4 - 4.2 mm; plain; snap-on type; light green</p>	<a href="http://www.wago.com/793-4501/000-023">www.wago.com/793-4501/000-023</a>
	<p><b>Item no.: 793-4501/000-024</b> WMB marking card; as card; stretchable 4 - 4.2 mm; plain; snap-on type; violet</p>	<a href="http://www.wago.com/793-4501/000-024">www.wago.com/793-4501/000-024</a>
<b>assembling</b>		
	<p><b>Item no.: 209-106</b> Mounting carrier; for isolated mounting on DIN 35 rails; gray</p>	<a href="http://www.wago.com/209-106">www.wago.com/209-106</a>
	<p><b>Item no.: 709-153</b> Cover; Type 1; suitable for cover carrier, type 1; 1 m long; transparent</p>	<a href="http://www.wago.com/709-153">www.wago.com/709-153</a>
<b>ferrule</b>		
	<p><b>Item no.: 216-101</b> Ferrule; Sleeve for 0.5 mm<sup>2</sup> / AWG 22; uninsulated; electro-tin plated</p>	<a href="http://www.wago.com/216-101">www.wago.com/216-101</a>
	<p><b>Item no.: 216-102</b> Ferrule; Sleeve for 0.75 mm<sup>2</sup> / AWG 20; uninsulated; electro-tin plated</p>	<a href="http://www.wago.com/216-102">www.wago.com/216-102</a>
	<p><b>Item no.: 216-103</b> Ferrule; Sleeve for 1 mm<sup>2</sup> / AWG 18; uninsulated; electro-tin plated</p>	<a href="http://www.wago.com/216-103">www.wago.com/216-103</a>
	<p><b>Item no.: 216-201</b> Ferrule; Sleeve for 0.5 mm<sup>2</sup> / 20 AWG; insulated; electro-tin plated; white</p>	<a href="http://www.wago.com/216-201">www.wago.com/216-201</a>
	<p><b>Item no.: 216-202</b> Ferrule; Sleeve for 0.75 mm<sup>2</sup> / 18 AWG; insulated; electro-tin plated; gray</p>	<a href="http://www.wago.com/216-202">www.wago.com/216-202</a>
	<p><b>Item no.: 216-203</b> Ferrule; Sleeve for 1 mm<sup>2</sup> / AWG 18; insulated; electro-tin plated; red</p>	<a href="http://www.wago.com/216-203">www.wago.com/216-203</a>

Subject to changes. Please also observe the further product documentation!

	<b>Item no.: 216-301</b> Ferrule; Sleeve for 0.25 mm <sup>2</sup> / AWG 24; insulated; electro-tin plated; yellow	<a href="http://www.wago.com/216-301">www.wago.com/216-301</a>
	<b>Item no.: 216-302</b> Ferrule; Sleeve for 0.34 mm <sup>2</sup> / 22 AWG; insulated; electro-tin plated; green	<a href="http://www.wago.com/216-302">www.wago.com/216-302</a>
<b>Insulation stop</b>		
	<b>Item no.: 279-470</b> Insulation stop; 0.08 - 0.2 mm <sup>2</sup> "s" (0.14 mm <sup>2</sup> "f-st"); 5 pieces/strip; white	<a href="http://www.wago.com/279-470">www.wago.com/279-470</a>
	<b>Item no.: 279-471</b> Insulation stop; 0.25 mm <sup>2</sup> ; 5 pieces/strip; dark gray	<a href="http://www.wago.com/279-471">www.wago.com/279-471</a>

## Downloads

### Documentation

#### Additional Information

Technical explanations	Apr 3, 2019	pdf 2.1 MB	Download
------------------------	-------------	---------------	----------

## CAD/CAE-Data

### CAD data

2D/3D Models 279-809/281-434	URL	Download
------------------------------	-----	----------

### CAE data

EPLAN Data Portal 279-809/281-434	URL	Download
-----------------------------------	-----	----------

WSCAD Universe 279-809/281-434	URL	Download
--------------------------------	-----	----------

## Installation Notes

### Jumpered

Subject to changes. Please also observe the further product documentation!

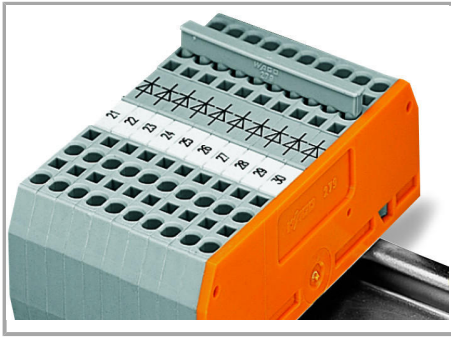

Commoning using comb-style jumper bars.  
Push comb-style jumper bars down until fully inserted.

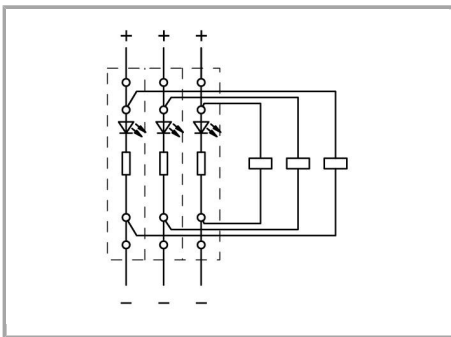

Circuit-related voltage indications can be created using the following terminal blocks:

279-809/281-434 or 279-809/281-413

Subject to changes. Please also observe the further product documentation!