

Data sheet | Item number: 279-508

Double-deck terminal block; 4-conductor through terminal block; L; internal commoning; conductor entry with violet marking; for DIN-rail 35 x 15 and 35 x 7.5; 1.5 mm²; CAGE CLAMP®; 1,50 mm²; gray

www.wago.com/279-508

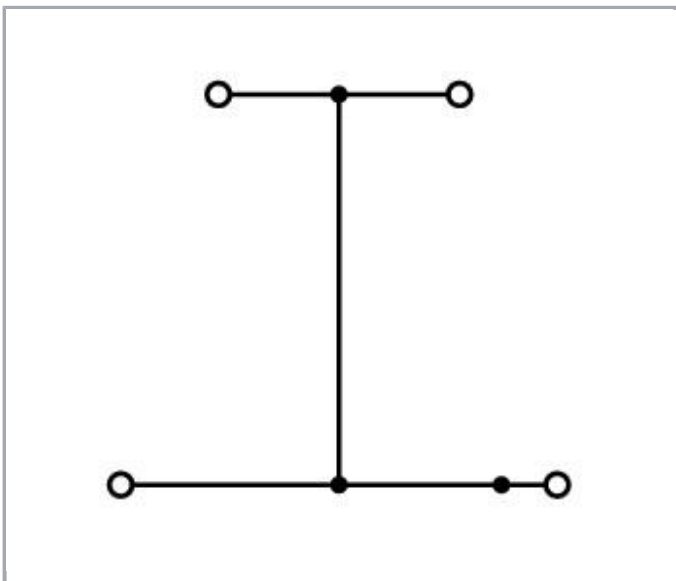
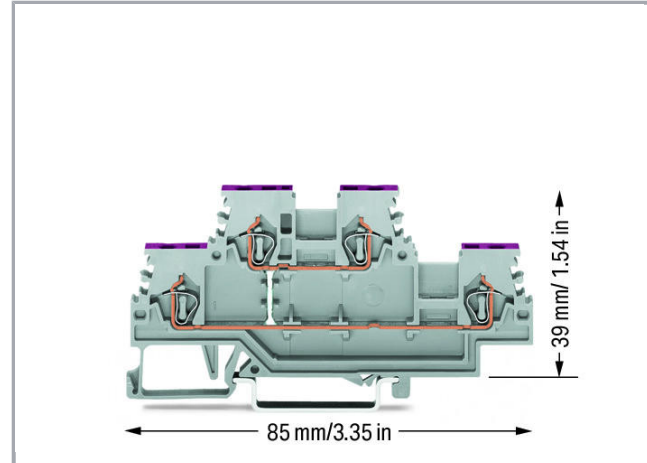
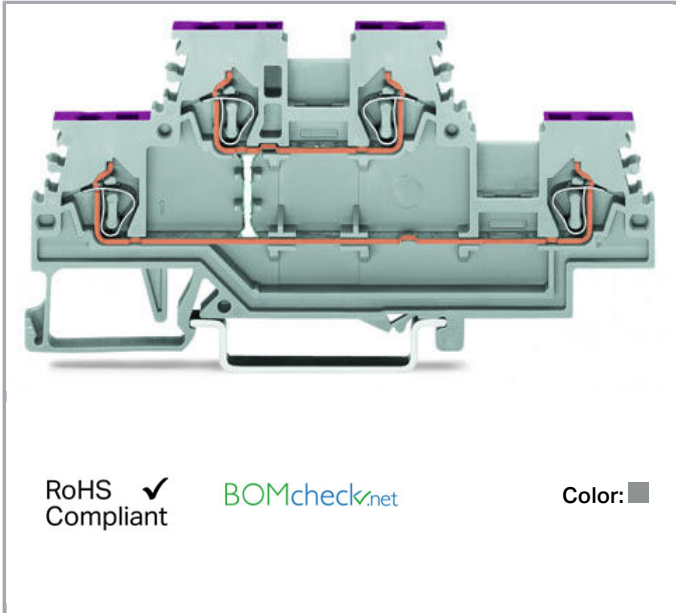

Data

Electrical data

Subject to changes. Please also observe the further product documentation!

WAGO Kontakttechnik GmbH & Co. KG
Hansastr. 27
32423 Minden
Phone: +49571 887-0 | Fax: +49571 887-169
Email: info.de@wago.com | Web: www.wago.com

Do you have any questions about our products?
We are always happy to take your call at +49 (571) 887-44222.



Ratings per IEC/EN 60664-1

Ratings per	IEC/EN 60947-7-1
Rated voltage (III / 3)	500 V
Rated impulse voltage (III / 3)	6 kV
Rated current	18 A
Legend (ratings)	(III / 3) ≙ Overvoltage category III / Pollution degree 3

Connection data

Connection technology	CAGE CLAMP®
Actuation type	Operating tool
Connectable conductor materials	Copper
Solid conductor	0,08 ... 1,5 mm ² / 28 ... 16 AWG
Fine-stranded conductor	0,08 ... 1,5 mm ² / 28 ... 16 AWG
Strip length	8 ... 9 mm / 0.31 ... 0.35 inch
Total number of connection points	4
Total number of potentials	1
Number of levels	2
Type of wiring	Front-entry wiring

Geometrical Data

Width	4 mm / 0.157 inch
Height from upper-edge of DIN-35 rail	39 mm / 1.535 inch
Depth	85 mm / 3.346 inch

Mechanical data

Design	horizontal type
Type of mounting	DIN-35 rail
Potential marking	L
Marking level	Side marking

Material Data

Color	gray
Insulating material	Polyamide 66 (PA 66)
Fire load	0.146 MJ
Weight	7.9 g



Subject to changes. Please also observe the further product documentation!

Commercial data



Product Group	1 (Rail Mounted Terminal Blocks)
Packaging type	BOX
Country of origin	DE
GTIN	4050821237266
Customs Tariff No.	85369010000

Approvals / Certificates

Country specific Approvals

Logo	Approval	Additional Approval Text	Certificate name
	CCA DEKRA Certification B.V.	EN 60947	NTR NL-7081
	CSA DEKRA Certification B.V.	C22.2 No. 158	70133738
	KEMA/KEUR DEKRA Certification B.V.	EN 60947	2160584.04

Ship Approvals

Logo	Approval	Additional Approval Text	Certificate name
	ABS American Bureau of Shipping	-	20-HG1941090-PDA
	DNV GL Det Norske Veritas, Germanischer Lloyd	-	TAE00001V2

UL-Approvals

Logo	Approval	Additional Approval Text	Certificate name
	UR Underwriters Laboratories Inc.	UL 1059	E45172









Subject to changes. Please also observe the further product documentation!



Counterpart

Compatible products

Jumper

	Item no.: 210-103 Wire commoning chain; insulated; 50 connections; black	www.wago.com/210-103
	Item no.: 249-123 Push-in type wire jumper; insulated; wire length 180 mm; Conductor cross section 0.75 mm ²	www.wago.com/249-123
	Item no.: 249-125 Push-in type wire jumper; insulated; wire length 60 mm; Conductor cross section 0.75 mm ²	www.wago.com/249-125
	Item no.: 249-126 Push-in type wire jumper; insulated; wire length 110 mm; Conductor cross section 0.75 mm ²	www.wago.com/249-126
	Item no.: 249-127 Push-in type wire jumper; insulated; wire length 250 mm; Conductor cross section 0.75 mm ²	www.wago.com/249-127
	Item no.: 279-402 Adjacent jumper; insulated; Nominal current 15 A; gray	www.wago.com/279-402
	Item no.: 279-409 Alternate jumper; insulated; Nominal current 15 A; gray	www.wago.com/279-409
	Item no.: 279-422 Adjacent jumper; insulated; Nominal current 15 A; yellow-green	www.wago.com/279-422
	Item no.: 279-482 Comb-style jumper bar; insulated; 2-way; IN = IN terminal block; gray	www.wago.com/279-482

Subject to changes. Please also observe the further product documentation!

WAGO Kontakttechnik GmbH & Co. KG
Hansastr. 27
32423 Minden
Phone: +49571 887-0 | Fax: +49571 887-169
Email: info.de@wago.com | Web: www.wago.com

Do you have any questions about our products?
We are always happy to take your call at +49 (571) 887-44222.



Item no.: 279-483
Comb-style jumper bar; insulated; 3-way; IN = IN terminal block; gray

www.wago.com/279-483



Item no.: 279-490
Comb-style jumper bar; insulated; 10-way; IN = IN terminal block; gray

www.wago.com/279-490



Item no.: 279-492
Alternate comb-style jumper bar; insulated; 2-way; IN = IN terminal block; gray

www.wago.com/279-492

Protective Warning Marker



Item no.: 279-415
Protective warning marker; with high-voltage symbol, black; for 5 terminal blocks; yellow

www.wago.com/279-415

General accessories



Item no.: 279-529
Adaptor; gray

www.wago.com/279-529

Insulation stop



Item no.: 279-470
Insulation stop; 0.08 - 0.2 mm² "s" (0.14 mm² "f-st"); 5 pieces/strip; white

www.wago.com/279-470



Item no.: 279-471
Insulation stop; 0.25 mm²; 5 pieces/strip; dark gray

www.wago.com/279-471

Marking accessories



Item no.: 2009-114
WMB-Inline; for Smart Printer; 2000 pieces on roll; stretchable 4 - 4.2 mm; plain; snap-on type; white

www.wago.com/2009-114



Item no.: 2009-114/000-002
WMB-Inline; for Smart Printer; 2000 pieces on roll; stretchable 4 - 4.2 mm; plain; snap-on type; yellow

www.wago.com/2009-114/000-002



Item no.: 2009-114/000-005
WMB-Inline; for Smart Printer; 2000 pieces on roll; stretchable 4 - 4.2 mm; plain; snap-on type; red

www.wago.com/2009-114/000-005



Item no.: 2009-114/000-006
WMB-Inline; for Smart Printer; 2000 pieces on roll; stretchable 4 - 4.2 mm; plain; snap-on type; blue

www.wago.com/2009-114/000-006



Item no.: 2009-114/000-007
WMB-Inline; for Smart Printer; 2000 pieces on roll; stretchable 4 - 4.2 mm; plain; snap-on type; gray

www.wago.com/2009-114/000-007



Item no.: 2009-114/000-012
WMB-Inline; for Smart Printer; 2000 pieces on roll; stretchable 4 - 4.2 mm; plain; snap-on type; orange













www.wago.com/2009-114/000-012



Item no.: 2009-114/000-023
WMB-Inline; for Smart Printer; 2000 pieces on roll; stretchable 4 - 4.2 mm; plain; snap-on type; green

www.wago.com/2009-114/000-023

Subject to changes. Please also observe the further product documentation!

	<p>Item no.: 2009-114/000-024 WMB-Inline; for Smart Printer; 2000 pieces on roll; stretchable 4 - 4.2 mm; plain; snap-on type; violet</p>	www.wago.com/2009-114/000-024
	<p>Item no.: 209-128 Adaptor; gray</p>	www.wago.com/209-128
	<p>Item no.: 209-140 Group marker carrier; gray</p>	www.wago.com/209-140
	<p>Item no.: 209-141 Group marker carrier; gray</p>	www.wago.com/209-141
	<p>Item no.: 209-142 Group marker carrier; gray</p>	www.wago.com/209-142
	<p>Item no.: 209-185 Adaptor; gray</p>	www.wago.com/209-185
	<p>Item no.: 249-105 Group marker carrier; gray</p>	www.wago.com/249-105
	<p>Item no.: 793-4501 WMB marking card; as card; stretchable 4 - 4.2 mm; plain; snap-on type; white</p>	www.wago.com/793-4501
	<p>Item no.: 793-4501/000-002 WMB marking card; as card; stretchable 4 - 4.2 mm; plain; snap-on type; yellow</p>	www.wago.com/793-4501/000-002
	<p>Item no.: 793-4501/000-005 WMB marking card; as card; stretchable 4 - 4.2 mm; plain; snap-on type; red</p>	www.wago.com/793-4501/000-005
	<p>Item no.: 793-4501/000-006 WMB marking card; as card; stretchable 4 - 4.2 mm; plain; snap-on type; blue</p>	www.wago.com/793-4501/000-006
	<p>Item no.: 793-4501/000-007 WMB marking card; as card; stretchable 4 - 4.2 mm; plain; snap-on type; gray</p>	www.wago.com/793-4501/000-007
	<p>Item no.: 793-4501/000-012 WMB marking card; as card; stretchable 4 - 4.2 mm; plain; snap-on type; orange</p>	www.wago.com/793-4501/000-012
	<p>Item no.: 793-4501/000-017 WMB marking card; as card; stretchable 4 - 4.2 mm; plain; snap-on type; green</p>	www.wago.com/793-4501/000-017
	<p>Item no.: 793-4501/000-023 WMB marking card; as card; stretchable 4 - 4.2 mm; plain; snap-on type; light green</p>	www.wago.com/793-4501/000-023

Subject to changes. Please also observe the further product documentation!

**Item no.: 793-4501/000-024**

WMB marking card; as card; stretchable 4 - 4.2 mm; plain; snap-on type; violet

www.wago.com/793-4501/000-024**tools****Item no.: 210-647**

Operating tool; Blade: 2.5 x 0.4 mm; with a partially insulated shaft

www.wago.com/210-647**Item no.: 210-648**

Operating tool; Blade: 2.5 x 0.4 mm; with a partially insulated shaft; angled; short

www.wago.com/210-648**Item no.: 210-719**

Operating tool; Blade: 2.5 x 0.4 mm; with a partially insulated shaft

www.wago.com/210-719**Test Accessories****Item no.: 209-170**Test plug adapter; 8.3 mm wide; for 4 mm Ø test plugs; suitable for 1.5 mm² - 10 mm² tbs; graywww.wago.com/209-170**Item no.: 280-404**Test plug adapter; 5 mm wide; for test plug 210-137 (2.3 mm Ø); suitable for 1.5 mm² - 4 mm² tbs; graywww.wago.com/280-404**ferrule****Item no.: 216-101**Ferrule; Sleeve for 0.5 mm² / AWG 22; uninsulated; electro-tin platedwww.wago.com/216-101**Item no.: 216-102**Ferrule; Sleeve for 0.75 mm² / AWG 20; uninsulated; electro-tin platedwww.wago.com/216-102**Item no.: 216-103**Ferrule; Sleeve for 1 mm² / AWG 18; uninsulated; electro-tin platedwww.wago.com/216-103**Item no.: 216-201**Ferrule; Sleeve for 0.5 mm² / 20 AWG; insulated; electro-tin plated; whitewww.wago.com/216-201**Item no.: 216-202**Ferrule; Sleeve for 0.75 mm² / 18 AWG; insulated; electro-tin plated; graywww.wago.com/216-202**Item no.: 216-203**Ferrule; Sleeve for 1 mm² / AWG 18; insulated; electro-tin plated; redwww.wago.com/216-203**Item no.: 216-301**Ferrule; Sleeve for 0.25 mm² / AWG 24; insulated; electro-tin plated; yellowwww.wago.com/216-301**Item no.: 216-302**Ferrule; Sleeve for 0.34 mm² / 22 AWG; insulated; electro-tin plated; greenwww.wago.com/216-302**Carrier rail****Item no.: 210-112**

Steel carrier rail; 35 x 7.5 mm; 1 mm thick; 2 m long; slotted; according to EN 60715; "Hole width 25 mm

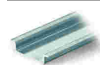
www.wago.com/210-112**Item no.: 210-113**

Steel carrier rail; 35 x 7.5 mm; 1 mm thick; 2 m long; unslotted; according to EN 60715

www.wago.com/210-113

Subject to changes. Please also observe the further product documentation!

WAGO Kontakttechnik GmbH & Co. KG

Hansastr. 27









32423 Minden

Phone: +49571 887-0 | Fax: +49571 887-169

Email: info.de@wago.com | Web: www.wago.com

Do you have any questions about our products?

We are always happy to take your call at +49 (571) 887-44222.

	Item no.: 210-114 Steel carrier rail; 35 x 15 mm; 1.5 mm thick; 2 m long; unslotted; similar to EN 60715	www.wago.com/210-114
	Item no.: 210-115 Steel carrier rail; 35 x 7.5 mm; 1 mm thick; 2 m long; slotted; according to EN 60715; "Hole width 18 mm	www.wago.com/210-115
	Item no.: 210-118 Steel carrier rail; 35 x 15 mm; 2.3 mm thick; 2 m long; unslotted; according to EN 60715	www.wago.com/210-118
	Item no.: 210-196 Aluminum carrier rail; 35 x 8.2 mm; 1.6 mm thick; 2 m long; unslotted; similar to EN 60715; silver-colored	www.wago.com/210-196
	Item no.: 210-197 Steel carrier rail; 35 x 15 mm; 1.5 mm thick; 2 m long; slotted; similar to EN 60715	www.wago.com/210-197
	Item no.: 210-198 Copper carrier rail; 35 x 15 mm; 2.3 mm thick; 2 m long; unslotted; according to EN 60715; copper-colored	www.wago.com/210-198
	Item no.: 210-504 Steel carrier rail; 35 x 7.5 mm; 1 mm thick; 2 m long; slotted; galvanized; according to EN 60715	www.wago.com/210-504
	Item no.: 210-505 Steel carrier rail; 35 x 7.5 mm; 1 mm thick; 2 m long; unslotted; galvanized; according to EN 60715	www.wago.com/210-505
	Item no.: 210-506 Steel carrier rail; 35 x 15 mm; 1.5 mm thick; 2 m long; unslotted; galvanized; similar to EN 60715	www.wago.com/210-506
	Item no.: 210-508 Steel carrier rail; 35 x 15 mm; 1.5 mm thick; 2 m long; slotted; galvanized; similar to EN 60715	www.wago.com/210-508
End plate		
	Item no.: 209-192 Separator for Ex e/Ex i applications; 3 mm thick; 125.5 mm wide; orange	www.wago.com/209-192
	Item no.: 279-518 End and intermediate plate; 2 mm thick; gray	www.wago.com/279-518
	Item no.: 279-519 End and intermediate plate; 2 mm thick; orange	www.wago.com/279-519
assembling		
	Item no.: 209-106 Mounting carrier; for isolated mounting on DIN 35 rails; gray	www.wago.com/209-106
	Item no.: 709-153 Cover; Type 1; suitable for cover carrier, type 1; 1 m long; transparent	www.wago.com/709-153

Subject to changes. Please also observe the further product documentation!

Downloads

Documentation

Additional Information

Technical explanations	Apr 3, 2019	pdf 2.1 MB	Download
------------------------	-------------	---------------	----------

CAD/CAE-Data

CAD data

2D/3D Models 279-508	URL	Download
----------------------	-----	----------

CAE data

EPLAN Data Portal 279-508	URL	Download
---------------------------	-----	----------

WSCAD Universe 279-508	URL	Download
------------------------	-----	----------

Installation Notes

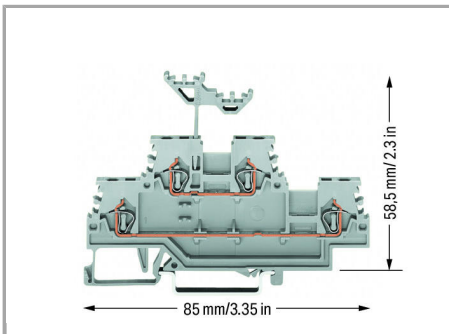

Double-deck marker carrier

(height including marker carrier)

Subject to changes. Please also observe the further product documentation!