

Data sheet | Item number: 279-501

Double-deck terminal block; Through/through terminal block; L/L; for DIN-rail
35 x 15 and 35 x 7.5; 1.5 mm²; CAGE CLAMP®; 1,50 mm²; gray

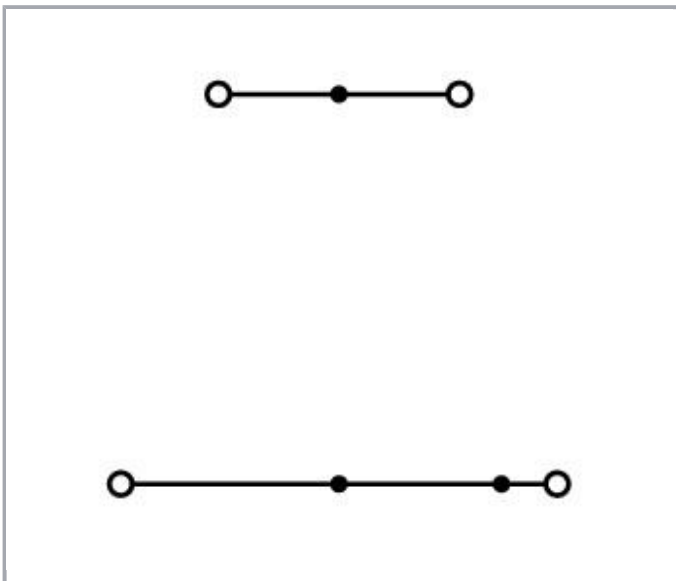

www.wago.com/279-501

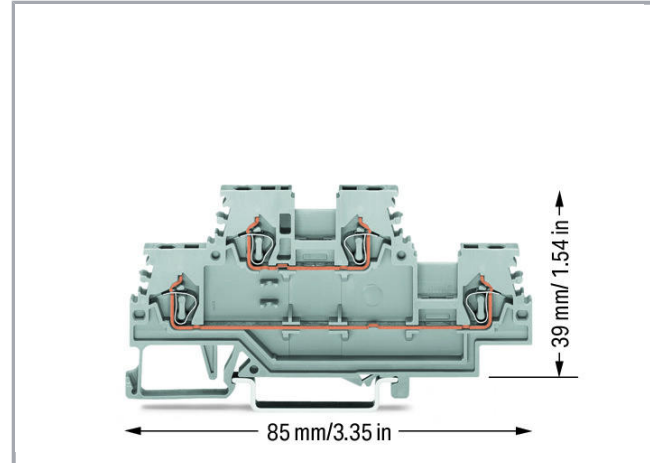
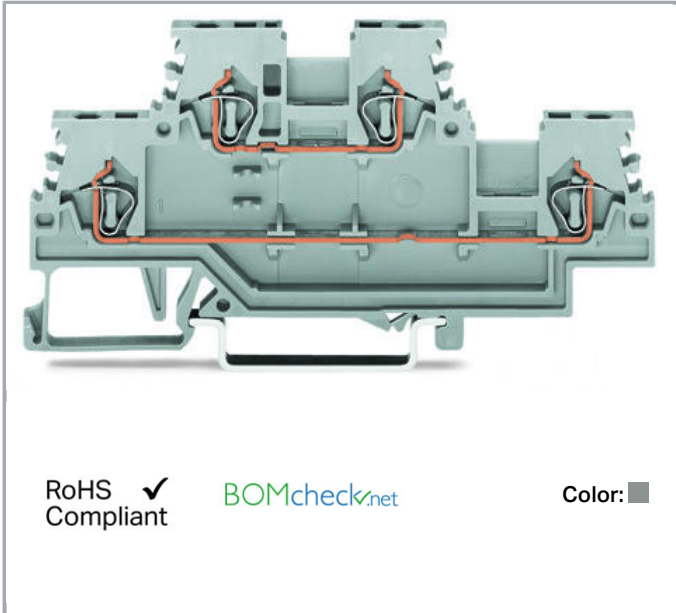

Data

Electrical data

Subject to changes. Please also observe the further product documentation!

WAGO Kontakttechnik GmbH & Co. KG
Hansastr. 27
32423 Minden
Phone: +49571 887-0 | Fax: +49571 887-169
Email: info.de@wago.com | Web: www.wago.com

Do you have any questions about our products?
We are always happy to take your call at +49 (571) 887-44222.

Ratings per IEC/EN 60664-1

Ratings per	IEC/EN 60947-7-1
Rated voltage (III / 3)	500 V
Rated impulse voltage (III / 3)	6 kV
Rated current	18 A
Legend (ratings)	(III / 3) ≙ Overvoltage category III / Pollution degree 3

Connection data

Connection technology	CAGE CLAMP®
Actuation type	Operating tool
Connectable conductor materials	Copper
Solid conductor	0,08 ... 1,5 mm ² / 28 ... 16 AWG
Fine-stranded conductor	0,08 ... 1,5 mm ² / 28 ... 16 AWG
Strip length	8 ... 9 mm / 0.31 ... 0.35 inch
Total number of connection points	4
Total number of potentials	2
Number of levels	2
Type of wiring	Front-entry wiring

Geometrical Data

Width	4 mm / 0.157 inch
Height from upper-edge of DIN-35 rail	39 mm / 1.535 inch
Depth	85 mm / 3.346 inch

Mechanical data

Design	horizontal type
Type of mounting	DIN-35 rail
Potential marking	L/L
Marking level	Side marking

Material Data

Color	gray
Insulating material	Polyamide 66 (PA 66)
Fire load	0.145 MJ
Weight	7.6 g



Subject to changes. Please also observe the further product documentation!

Commercial data



Product Group	1 (Rail Mounted Terminal Blocks)
Packaging type	BOX
Country of origin	DE
GTIN	4050821109310
Customs Tariff No.	85369010000

Approvals / Certificates

Country specific Approvals

Logo	Approval	Additional Approval Text	Certificate name
	CCA DEKRA Certification B.V.	EN 60947	NTR NL-7081
	CSA DEKRA Certification B.V.	C22.2 No. 158	70133738
	KEMA/KEUR DEKRA Certification B.V.	EN 60947	2160584.04

Ship Approvals

Logo	Approval	Additional Approval Text	Certificate name
	ABS American Bureau of Shipping	-	20-HG1941090-PDA
	DNV GL Det Norske Veritas, Germanischer Lloyd	-	TAE00001V2

UL-Approvals

Logo	Approval	Additional Approval Text	Certificate name
	UR Underwriters Laboratories Inc.	UL 1059	E45172

Subject to changes. Please also observe the further product documentation!



Counterpart

Compatible products

assembling

Item no.: 209-106 Mounting carrier; for isolated mounting on DIN 35 rails; gray	www.wago.com/209-106
---	--

Item no.: 709-153 Cover; Type 1; suitable for cover carrier, type 1; 1 m long; transparent	www.wago.com/709-153
--	--

Marking accessories

Item no.: 2009-114 WMB-Inline; for Smart Printer; 2000 pieces on roll; stretchable 4 - 4.2 mm; plain; snap-on type; white	www.wago.com/2009-114
---	--











 Item no.: 2009-114/000-002 WMB-Inline; for Smart Printer; 2000 pieces on roll; stretchable 4 - 4.2 mm; plain; snap-on type; yellow	www.wago.com/2009-114/000-002
---	--

Item no.: 2009-114/000-005 WMB-Inline; for Smart Printer; 2000 pieces on roll; stretchable 4 - 4.2 mm; plain; snap-on type; red	www.wago.com/2009-114/000-005
---	--

 Item no.: 2009-114/000-006 WMB-Inline; for Smart Printer; 2000 pieces on roll; stretchable 4 - 4.2 mm; plain; snap-on type; blue	www.wago.com/2009-114/000-006
---	--

 Item no.: 2009-114/000-007 WMB-Inline; for Smart Printer; 2000 pieces on roll; stretchable 4 - 4.2 mm; plain; snap-on type; gray	www.wago.com/2009-114/000-007
---	--

Subject to changes. Please also observe the further product documentation!

	<p>Item no.: 2009-114/000-012 WMB-Inline; for Smart Printer; 2000 pieces on roll; stretchable 4 - 4.2 mm; plain; snap-on type; orange</p>	www.wago.com/2009-114/000-012
	<p>Item no.: 2009-114/000-023 WMB-Inline; for Smart Printer; 2000 pieces on roll; stretchable 4 - 4.2 mm; plain; snap-on type; green</p>	www.wago.com/2009-114/000-023
	<p>Item no.: 2009-114/000-024 WMB-Inline; for Smart Printer; 2000 pieces on roll; stretchable 4 - 4.2 mm; plain; snap-on type; violet</p>	www.wago.com/2009-114/000-024
	<p>Item no.: 209-128 Adaptor; gray</p>	www.wago.com/209-128
	<p>Item no.: 209-140 Group marker carrier; gray</p>	www.wago.com/209-140
	<p>Item no.: 209-141 Group marker carrier; gray</p>	www.wago.com/209-141
	<p>Item no.: 209-142 Group marker carrier; gray</p>	www.wago.com/209-142
	<p>Item no.: 209-185 Adaptor; gray</p>	www.wago.com/209-185
	<p>Item no.: 249-105 Group marker carrier; gray</p>	www.wago.com/249-105
	<p>Item no.: 793-4501 WMB marking card; as card; stretchable 4 - 4.2 mm; plain; snap-on type; white</p>	www.wago.com/793-4501
	<p>Item no.: 793-4501/000-002 WMB marking card; as card; stretchable 4 - 4.2 mm; plain; snap-on type; yellow</p>	www.wago.com/793-4501/000-002
	<p>Item no.: 793-4501/000-005 WMB marking card; as card; stretchable 4 - 4.2 mm; plain; snap-on type; red</p>	www.wago.com/793-4501/000-005
	<p>Item no.: 793-4501/000-006 WMB marking card; as card; stretchable 4 - 4.2 mm; plain; snap-on type; blue</p>	www.wago.com/793-4501/000-006
	<p>Item no.: 793-4501/000-007 WMB marking card; as card; stretchable 4 - 4.2 mm; plain; snap-on type; gray</p>	www.wago.com/793-4501/000-007
	<p>Item no.: 793-4501/000-012 WMB marking card; as card; stretchable 4 - 4.2 mm; plain; snap-on type; orange</p>	www.wago.com/793-4501/000-012

Subject to changes. Please also observe the further product documentation!



Item no.: 793-4501/000-017
WMB marking card; as card; stretchable 4 - 4.2 mm; plain; snap-on type; green

www.wago.com/793-4501/000-017

Item no.: 793-4501/000-023
WMB marking card; as card; stretchable 4 - 4.2 mm; plain; snap-on type; light green

www.wago.com/793-4501/000-023

Item no.: 793-4501/000-024
WMB marking card; as card; stretchable 4 - 4.2 mm; plain; snap-on type; violet

www.wago.com/793-4501/000-024

Protective Warning Marker



Item no.: 279-415
Protective warning marker; with high-voltage symbol, black; for 5 terminal blocks; yellow

www.wago.com/279-415

Test Accessories



Item no.: 209-170
Test plug adapter; 8.3 mm wide; for 4 mm Ø test plugs; suitable for 1.5 mm² - 10 mm² tbs; gray

www.wago.com/209-170



Item no.: 280-404
Test plug adapter; 5 mm wide; for test plug 210-137 (2.3 mm Ø); suitable for 1.5 mm² - 4 mm² tbs; gray

www.wago.com/280-404

tools



Item no.: 210-647
Operating tool; Blade: 2.5 x 0.4 mm; with a partially insulated shaft

www.wago.com/210-647



Item no.: 210-648
Operating tool; Blade: 2.5 x 0.4 mm; with a partially insulated shaft; angled; short

www.wago.com/210-648



Item no.: 210-719
Operating tool; Blade: 2.5 x 0.4 mm; with a partially insulated shaft

www.wago.com/210-719

End plate



Item no.: 209-192
Separator for Ex e/Ex i applications; 3 mm thick; 125.5 mm wide; orange

www.wago.com/209-192



Item no.: 279-518
End and intermediate plate; 2 mm thick; gray

www.wago.com/279-518



Item no.: 279-519
End and intermediate plate; 2 mm thick; orange

www.wago.com/279-519

Carrier rail

Item no.: 210-112
Steel carrier rail; 35 x 7.5 mm; 1 mm thick; 2 m long; slotted; according to EN 60715; "Hole width 25 mm

www.wago.com/210-112

Item no.: 210-113
Steel carrier rail; 35 x 7.5 mm; 1 mm thick; 2 m long; unslotted; according to EN 60715

www.wago.com/210-113





Item no.: 210-114
Steel carrier rail; 35 x 15 mm; 1.5 mm thick; 2 m long; unslotted; similar to EN 60715

www.wago.com/210-114

Subject to changes. Please also observe the further product documentation!

Item no.: 210-115 Steel carrier rail; 35 x 7.5 mm; 1 mm thick; 2 m long; slotted; according to EN 60715; "Hole width 18 mm	www.wago.com/210-115
Item no.: 210-118 Steel carrier rail; 35 x 15 mm; 2.3 mm thick; 2 m long; unslotted; according to EN 60715	www.wago.com/210-118
Item no.: 210-196 Aluminum carrier rail; 35 x 8.2 mm; 1.6 mm thick; 2 m long; unslotted; similar to EN 60715; silver-colored	www.wago.com/210-196
Item no.: 210-197 Steel carrier rail; 35 x 15 mm; 1.5 mm thick; 2 m long; slotted; similar to EN 60715	www.wago.com/210-197
Item no.: 210-198 Copper carrier rail; 35 x 15 mm; 2.3 mm thick; 2 m long; unslotted; according to EN 60715; copper-colored	www.wago.com/210-198
Item no.: 210-504 Steel carrier rail; 35 x 7.5 mm; 1 mm thick; 2 m long; slotted; galvanized; according to EN 60715	www.wago.com/210-504
Item no.: 210-505 Steel carrier rail; 35 x 7.5 mm; 1 mm thick; 2 m long; unslotted; galvanized; according to EN 60715	www.wago.com/210-505
Item no.: 210-506 Steel carrier rail; 35 x 15 mm; 1.5 mm thick; 2 m long; unslotted; galvanized; similar to EN 60715	www.wago.com/210-506
Item no.: 210-508 Steel carrier rail; 35 x 15 mm; 1.5 mm thick; 2 m long; slotted; galvanized; similar to EN 60715	www.wago.com/210-508

ferrule

 Item no.: 216-101 Ferrule; Sleeve for 0.5 mm ² / AWG 22; uninsulated; electro-tin plated	www.wago.com/216-101
Item no.: 216-102 Ferrule; Sleeve for 0.75 mm ² / AWG 20; uninsulated; electro-tin plated	www.wago.com/216-102
Item no.: 216-103 Ferrule; Sleeve for 1 mm ² / AWG 18; uninsulated; electro-tin plated	www.wago.com/216-103
 Item no.: 216-201 Ferrule; Sleeve for 0.5 mm ² / 20 AWG; insulated; electro-tin plated; white	www.wago.com/216-201
Item no.: 216-202 Ferrule; Sleeve for 0.75 mm ² / 18 AWG; insulated; electro-tin plated; gray	www.wago.com/216-202
 Item no.: 216-203 Ferrule; Sleeve for 1 mm ² / AWG 18; insulated; electro-tin plated; red	www.wago.com/216-203
Item no.: 216-301 Ferrule; Sleeve for 0.25 mm ² / AWG 24; insulated; electro-tin plated; yellow	www.wago.com/216-301
 Item no.: 216-302 Ferrule; Sleeve for 0.34 mm ² / 22 AWG; insulated; electro-tin plated; green	www.wago.com/216-302

General accessories

Subject to changes. Please also observe the further product documentation!



Item no.: 279-529
Adaptor; gray

www.wago.com/279-529

Insulation stop



Item no.: 279-470
Insulation stop; 0.08 - 0.2 mm² "s" (0.14 mm² "f-st"); 5 pieces/strip; white

www.wago.com/279-470



Item no.: 279-471
Insulation stop; 0.25 mm²; 5 pieces/strip; dark gray

www.wago.com/279-471

Jumper



Item no.: 210-103
Wire commoning chain; insulated; 50 connections; black

www.wago.com/210-103



Item no.: 249-123
Push-in type wire jumper; insulated; wire length 180 mm; Conductor cross section 0.75 mm²

www.wago.com/249-123

Item no.: 249-125
Push-in type wire jumper; insulated; wire length 60 mm; Conductor cross section 0.75 mm²

www.wago.com/249-125

Item no.: 249-126
Push-in type wire jumper; insulated; wire length 110 mm; Conductor cross section 0.75 mm²

www.wago.com/249-126



Item no.: 249-127
Push-in type wire jumper; insulated; wire length 250 mm; Conductor cross section 0.75 mm²

www.wago.com/249-127



Item no.: 279-402
Adjacent jumper; insulated; Nominal current 15 A; gray

www.wago.com/279-402



Item no.: 279-409
Alternate jumper; insulated; Nominal current 15 A; gray

www.wago.com/279-409



Item no.: 279-422
Adjacent jumper; insulated; Nominal current 15 A; yellow-green

www.wago.com/279-422



Item no.: 279-482
Comb-style jumper bar; insulated; 2-way; IN = IN terminal block; gray

www.wago.com/279-482



Item no.: 279-483
Comb-style jumper bar; insulated; 3-way; IN = IN terminal block; gray

www.wago.com/279-483



Item no.: 279-490
Comb-style jumper bar; insulated; 10-way; IN = IN terminal block; gray

www.wago.com/279-490



Item no.: 279-492
Alternate comb-style jumper bar; insulated; 2-way; IN = IN terminal block; gray

www.wago.com/279-492

Downloads

Documentation

Additional Information

Technical explanations

Apr 3, 2019

pdf

Download

Subject to changes. Please also observe the further product documentation!

WAGO Kontakttechnik GmbH & Co. KG

Hansastr. 27

32423 Minden

Phone: +49571 887-0 | Fax: +49571 887-169

Email: info.de@wago.com | Web: www.wago.com

Do you have any questions about our products?

We are always happy to take your call at +49 (571) 887-44222.

CAD/CAE-Data

CAD data

2D/3D Models 279-501	URL	Download
----------------------	---------------------	--------------------------

CAE data

EPLAN Data Portal 279-501	URL	Download
---------------------------	---------------------	--------------------------

WSCAD Universe 279-501	URL	Download
------------------------	---------------------	--------------------------

Installation Notes

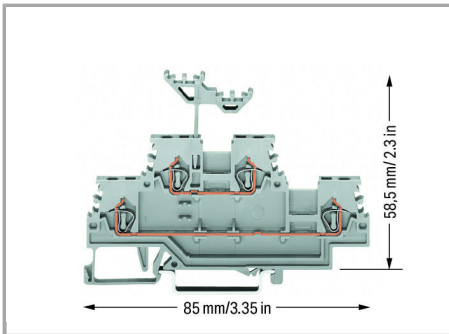

Double-deck marker carrier

(height including marker carrier)

Subject to changes. Please also observe the further product documentation!