

Data sheet | Item number: 270-577

3-conductor sensor/actuator terminal block; with colored conductor entries;  
2.5 mm<sup>2</sup>; CAGE CLAMP®; 2,50 mm<sup>2</sup>; orange

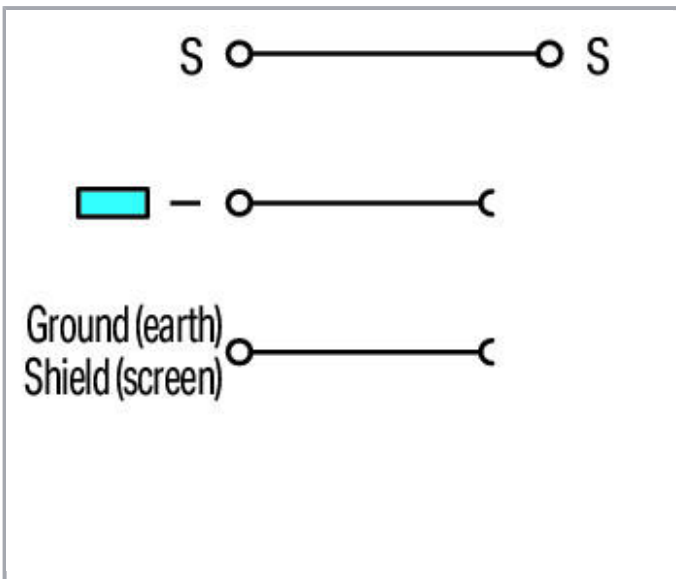

[www.wago.com/270-577](http://www.wago.com/270-577)

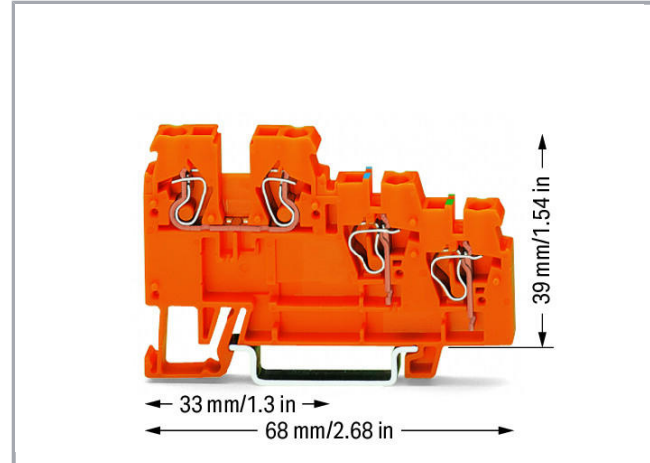
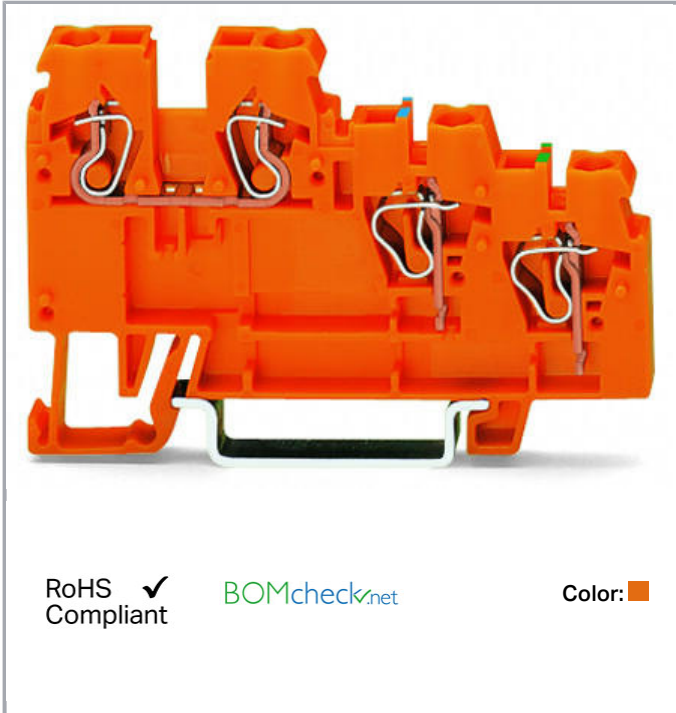

Data

Subject to changes. Please also observe the further product documentation!

WAGO Kontakttechnik GmbH & Co. KG  
Hansastr. 27  
32423 Minden  
Phone: +49571 887-0 | Fax: +49571 887-169  
Email: [info.de@wago.com](mailto:info.de@wago.com) | Web: [www.wago.com](http://www.wago.com)

Do you have any questions about our products?  
We are always happy to take your call at +49 (571) 887-44222.



## Electrical data

### Ratings per IEC/EN 60664-1

Rated voltage (III / 3)	250 V
Rated impulse voltage (III / 3)	4 kV
Rated current	18 A
Legend (ratings)	(III / 3) $\hat{=}$ Overvoltage category III / Pollution degree 3

## Connection data

Connection technology	CAGE CLAMP®
Actuation type	Operating tool
Connectable conductor materials	Copper
Solid conductor	0,08 ... 2,5 mm <sup>2</sup> / 28 ... 12 AWG
Fine-stranded conductor	0,08 ... 2,5 mm <sup>2</sup> / 28 ... 12 AWG
Strip length	6 ... 7 mm / 0.24 ... 0.28 inch
Total number of connection points	4
Total number of potentials	3
Number of levels	3
Type of wiring	Front-entry wiring
Note (conductor cross-section)	12 AWG: THHN, THWN

## Geometrical Data

Width	5 mm / 0.197 inch
Height from upper-edge of DIN-35 rail	39 mm / 1.535 inch
Depth	68 mm / 2.677 inch

## Mechanical data

Design	horizontal type
Type of mounting	DIN-35 rail
Marking level	Side marking

## Material Data

Color	orange
Fire load	0.172 MJ
Weight	8.9 g



Subject to changes. Please also observe the further product documentation!

## Commercial data

Product Group	1 (Rail Mounted Terminal Blocks)
Packaging type	BOX
Country of origin	CN
GTIN	4050821035275
Customs Tariff No.	85369010000

## Approvals / Certificates

### Country specific Approvals

Logo	Approval	Additional Approval Text	Certificate name
	CCA DEKRA Certification B.V.	EN 60947	2143311.03
	CCA DEKRA Certification B.V.	EN 60947	NTR NL 6828
	CSA DEKRA Certification B.V.	C22.2	1565649

### UL-Approvals

Logo	Approval	Additional Approval Text	Certificate name
	UR Underwriters Laboratories Inc.	UL 1059	20190731- E45172

## Counterpart

## Compatible products

Subject to changes. Please also observe the further product documentation!

WAGO Kontakttechnik GmbH & Co. KG  
 Hansastr. 27  
 32423 Minden  
 Phone: +49571 887-0 | Fax: +49571 887-169  
 Email: [info.de@wago.com](mailto:info.de@wago.com) | Web: [www.wago.com](http://www.wago.com)

Do you have any questions about our products?  
 We are always happy to take your call at +49 (571) 887-44222.





## Jumper

	<b>Item no.: 270-409</b> Jumper; unplated; 9-way; Nominal current 18 A; silver-colored	<a href="http://www.wago.com/270-409">www.wago.com/270-409</a>
	<b>Item no.: 270-417</b> Jumper; unplated; 17-way; Nominal current 18 A; silver-colored	<a href="http://www.wago.com/270-417">www.wago.com/270-417</a>
	<b>Item no.: 270-480</b> Jumper; unplated; 80-way; Nominal current 18 A; silver-colored	<a href="http://www.wago.com/270-480">www.wago.com/270-480</a>
	<b>Item no.: 870-402</b> Push-in type jumper bar; insulated; 2-way; Nominal current 18 A; light gray	<a href="http://www.wago.com/870-402">www.wago.com/870-402</a>
	<b>Item no.: 870-403</b> Push-in type jumper bar; insulated; 3-way; Nominal current 18 A; light gray	<a href="http://www.wago.com/870-403">www.wago.com/870-403</a>
	<b>Item no.: 870-404</b> Push-in type jumper bar; insulated; 4-way; Nominal current 18 A; light gray	<a href="http://www.wago.com/870-404">www.wago.com/870-404</a>
	<b>Item no.: 870-405</b> Push-in type jumper bar; insulated; 5-way; Nominal current 18 A; light gray	<a href="http://www.wago.com/870-405">www.wago.com/870-405</a>
	<b>Item no.: 870-405/011-000</b> Ready-made push-in type jumper bar; insulated; 3-way (1-3-5); Nominal current 18 A; light gray	<a href="http://www.wago.com/870-405/011-000">www.wago.com/870-405/011-000</a>
	<b>Item no.: 870-406</b> Push-in type jumper bar; insulated; 6-way; Nominal current 18 A; light gray	<a href="http://www.wago.com/870-406">www.wago.com/870-406</a>
	<b>Item no.: 870-407</b> Push-in type jumper bar; insulated; 7-way; Nominal current 18 A; light gray	<a href="http://www.wago.com/870-407">www.wago.com/870-407</a>
	<b>Item no.: 870-407/011-000</b> Ready-made push-in type jumper bar; insulated; 1-3-5-7; Nominal current 18 A; light gray	<a href="http://www.wago.com/870-407/011-000">www.wago.com/870-407/011-000</a>
	<b>Item no.: 870-408</b> Push-in type jumper bar; insulated; 8-way; Nominal current 18 A; light gray	<a href="http://www.wago.com/870-408">www.wago.com/870-408</a>
	<b>Item no.: 870-409</b> Push-in type jumper bar; insulated; 9-way; Nominal current 18 A; light gray	<a href="http://www.wago.com/870-409">www.wago.com/870-409</a>
	<b>Item no.: 870-409/011-000</b> Ready-made push-in type jumper bar; insulated; 1-3-5-7-9; Nominal current 18 A; light gray	<a href="http://www.wago.com/870-409/011-000">www.wago.com/870-409/011-000</a>

## ferrule

	<b>Item no.: 216-121</b> Ferrule; Sleeve for 0.5 mm <sup>2</sup> / AWG 22; uninsulated; electro-tin plated	<a href="http://www.wago.com/216-121">www.wago.com/216-121</a>
	<b>Item no.: 216-122</b>	

Subject to changes. Please also observe the further product documentation!

	Ferrule; Sleeve for 0.75 mm <sup>2</sup> / AWG 20; uninsulated; electro-tin plated	<a href="http://www.wago.com/216-122">www.wago.com/216-122</a>
	<b>Item no.: 216-123</b> Ferrule; Sleeve for 1 mm <sup>2</sup> / AWG 18; uninsulated; electro-tin plated	<a href="http://www.wago.com/216-123">www.wago.com/216-123</a>
	<b>Item no.: 216-124</b> Ferrule; Sleeve for 1.5 mm <sup>2</sup> / AWG 16; uninsulated; electro-tin plated	<a href="http://www.wago.com/216-124">www.wago.com/216-124</a>
	<b>Item no.: 216-131</b> Ferrule; Sleeve for 0.25 mm <sup>2</sup> / AWG 24; uninsulated; electro-tin plated	<a href="http://www.wago.com/216-131">www.wago.com/216-131</a>
	<b>Item no.: 216-132</b> Ferrule; Sleeve for 0.34 mm <sup>2</sup> / AWG 24; uninsulated; electro-tin plated	<a href="http://www.wago.com/216-132">www.wago.com/216-132</a>
	<b>Item no.: 216-221</b> Ferrule; Sleeve for 0.5 mm <sup>2</sup> / 20 AWG; insulated; electro-tin plated; white	<a href="http://www.wago.com/216-221">www.wago.com/216-221</a>
	<b>Item no.: 216-222</b> Ferrule; Sleeve for 0.75 mm <sup>2</sup> / 18 AWG; insulated; electro-tin plated; gray	<a href="http://www.wago.com/216-222">www.wago.com/216-222</a>
	<b>Item no.: 216-223</b> Ferrule; Sleeve for 1 mm <sup>2</sup> / AWG 18; insulated; electro-tin plated; red	<a href="http://www.wago.com/216-223">www.wago.com/216-223</a>
	<b>Item no.: 216-224</b> Ferrule; Sleeve for 1.5 mm <sup>2</sup> / AWG 16; insulated; electro-tin plated; black	<a href="http://www.wago.com/216-224">www.wago.com/216-224</a>
	<b>Item no.: 216-321</b> Ferrule; Sleeve for 0.25 mm <sup>2</sup> / AWG 24; insulated; electro-tin plated; yellow	<a href="http://www.wago.com/216-321">www.wago.com/216-321</a>
	<b>Item no.: 216-322</b> Ferrule; Sleeve for 0.34 mm <sup>2</sup> / 22 AWG; insulated; electro-tin plated; green	<a href="http://www.wago.com/216-322">www.wago.com/216-322</a>
<b>End plate</b>		
	<b>Item no.: 270-321</b> End and intermediate plate; 1 mm thick; for triple-deck terminal blocks; orange	<a href="http://www.wago.com/270-321">www.wago.com/270-321</a>
<b>tools</b>		
	<b>Item no.: 210-657</b> Operating tool; Blade: 3.5 x 0.5 mm; with a partially insulated shaft; short	<a href="http://www.wago.com/210-657">www.wago.com/210-657</a>
	<b>Item no.: 210-720</b> Operating tool; Blade: 3.5 x 0.5 mm; with a partially insulated shaft	<a href="http://www.wago.com/210-720">www.wago.com/210-720</a>
<b>Marking accessories</b>		
	<b>Item no.: 2009-115</b> WMB-Inline; for Smart Printer; 1500 pieces on roll; stretchable 5 - 5.2 mm; plain; snap-on type; white	<a href="http://www.wago.com/2009-115">www.wago.com/2009-115</a>
	<b>Item no.: 2009-115/000-002</b> WMB-Inline; for Smart Printer; 1500 pieces on roll; stretchable 5 - 5.2 mm; plain; snap-on type; yellow	<a href="http://www.wago.com/2009-115/000-002">www.wago.com/2009-115/000-002</a>

Subject to changes. Please also observe the further product documentation!



**Item no.: 2009-115/000-006**  
WMB-Inline; for Smart Printer; 1500 pieces on roll; stretchable 5 - 5.2 mm; plain; snap-on type; white [www.wago.com/2009-115/000-006](http://www.wago.com/2009-115/000-006)

---

**Item no.: 2009-115/000-007**  
WMB-Inline; for Smart Printer; 1500 pieces on roll; stretchable 5 - 5.2 mm; plain; snap-on type; gray [www.wago.com/2009-115/000-007](http://www.wago.com/2009-115/000-007)

---

**Item no.: 2009-115/000-012**  
WMB-Inline; for Smart Printer; 1500 pieces on roll; stretchable 5 - 5.2 mm; plain; snap-on type; white [www.wago.com/2009-115/000-012](http://www.wago.com/2009-115/000-012)

---

**Item no.: 2009-115/000-017**  
WMB-Inline; for Smart Printer; 1500 pieces on roll; stretchable 5 - 5.2 mm; plain; snap-on type; white [www.wago.com/2009-115/000-017](http://www.wago.com/2009-115/000-017)

---

**Item no.: 2009-115/000-023**  
WMB-Inline; for Smart Printer; 1500 pieces on roll; stretchable 5 - 5.2 mm; plain; snap-on type; green [www.wago.com/2009-115/000-023](http://www.wago.com/2009-115/000-023)

---

**Item no.: 2009-115/000-024**  
WMB-Inline; for Smart Printer; 1500 pieces on roll; stretchable 5 - 5.2 mm; plain; snap-on type; white [www.wago.com/2009-115/000-024](http://www.wago.com/2009-115/000-024)

---

**Item no.: 2009-145**  
Mini-WSB Inline; for Smart Printer; 1700 pieces on roll; stretchable 5 - 5.2 mm; plain; snap-on type; white [www.wago.com/2009-145](http://www.wago.com/2009-145)

---

**Item no.: 2009-145/000-002**  
Mini-WSB Inline; for Smart Printer; 1700 pieces on roll; stretchable 5 - 5.2 mm; plain; snap-on type; white [www.wago.com/2009-145/000-002](http://www.wago.com/2009-145/000-002)

---

**Item no.: 2009-145/000-005**  
Mini-WSB Inline; for Smart Printer; 1700 pieces on roll; stretchable 5 - 5.2 mm; plain; snap-on type; red [www.wago.com/2009-145/000-005](http://www.wago.com/2009-145/000-005)

---

**Item no.: 2009-145/000-006**  
Mini-WSB Inline; for Smart Printer; 1700 pieces on roll; stretchable 5 - 5.2 mm; plain; snap-on type; blue [www.wago.com/2009-145/000-006](http://www.wago.com/2009-145/000-006)

---

**Item no.: 2009-145/000-007**  
Mini-WSB Inline; for Smart Printer; 1700 pieces on roll; stretchable 5 - 5.2 mm; plain; snap-on type; white [www.wago.com/2009-145/000-007](http://www.wago.com/2009-145/000-007)

---

**Item no.: 2009-145/000-012**  
Mini-WSB Inline; for Smart Printer; 1700 pieces on roll; stretchable 5 - 5.2 mm; plain; snap-on type; orange [www.wago.com/2009-145/000-012](http://www.wago.com/2009-145/000-012)

---

**Item no.: 2009-145/000-023**  
Mini-WSB Inline; for Smart Printer; 1700 pieces on roll; stretchable 5 - 5.2 mm; plain; snap-on type; green [www.wago.com/2009-145/000-023](http://www.wago.com/2009-145/000-023)

---

**Item no.: 2009-145/000-024**

Subject to changes. Please also observe the further product documentation!

WAGO Kontakttechnik GmbH & Co. KG  
Hansastr. 27  
32423 Minden  
Phone: +49571 887-0 | Fax: +49571 887-169  
Email: [info.de@wago.com](mailto:info.de@wago.com) | Web: [www.wago.com](http://www.wago.com)

Do you have any questions about our products?  
We are always happy to take your call at +49 (571) 887-44222.

Mini-WSB Inline; for Smart Printer; 1700 pieces on roll; stretchable 5 - 5.2 mm; plain; snap-on type; violet

[www.wago.com/2009-145/000-024](http://www.wago.com/2009-145/000-024)



**Item no.: 248-501**

Miniature WSB Quick marking system; plain; Marker width 5 mm; 10 strips with 10 markers per card

[www.wago.com/248-501](http://www.wago.com/248-501)

**Item no.: 248-501/000-002**

Mini-WSB marking card; as card; not stretchable; plain; snap-on type; yellow

[www.wago.com/248-501/000-002](http://www.wago.com/248-501/000-002)



**Item no.: 248-501/000-005**

Mini-WSB marking card; as card; not stretchable; plain; snap-on type; red

[www.wago.com/248-501/000-005](http://www.wago.com/248-501/000-005)



**Item no.: 248-501/000-006**

Mini-WSB marking card; as card; not stretchable; plain; snap-on type; blue

[www.wago.com/248-501/000-006](http://www.wago.com/248-501/000-006)



**Item no.: 248-501/000-007**

Mini-WSB marking card; as card; not stretchable; plain; snap-on type; gray

[www.wago.com/248-501/000-007](http://www.wago.com/248-501/000-007)



**Item no.: 248-501/000-012**

Mini-WSB marking card; as card; not stretchable; plain; snap-on type; orange

[www.wago.com/248-501/000-012](http://www.wago.com/248-501/000-012)

**Item no.: 248-501/000-017**

Mini-WSB marking card; as card; not stretchable; plain; snap-on type; light green

[www.wago.com/248-501/000-017](http://www.wago.com/248-501/000-017)

**Item no.: 248-501/000-023**

Mini-WSB marking card; as card; not stretchable; plain; snap-on type; green

[www.wago.com/248-501/000-023](http://www.wago.com/248-501/000-023)

**Item no.: 248-501/000-024**

Mini-WSB marking card; as card; not stretchable; plain; snap-on type; violet

[www.wago.com/248-501/000-024](http://www.wago.com/248-501/000-024)

**Item no.: 709-177**

Marking strips; on reel; 7.5 mm wide; not stretchable; plain; snap-on type; translucent

[www.wago.com/709-177](http://www.wago.com/709-177)

**Item no.: 709-178**

Marking strips; on reel; 7.5 mm wide; not stretchable; plain; snap-on type; white

[www.wago.com/709-178](http://www.wago.com/709-178)

**Item no.: 709-196**

Marking strips; for laser printer; translucent

[www.wago.com/709-196](http://www.wago.com/709-196)

**Item no.: 709-198**

Marking strips; white

[www.wago.com/709-198](http://www.wago.com/709-198)

**Item no.: 793-501**

WMB marking card; as card; not stretchable; plain; snap-on type; white

[www.wago.com/793-501](http://www.wago.com/793-501)

Subject to changes. Please also observe the further product documentation!

WAGO Kontakttechnik GmbH & Co. KG

Hansastr. 27

32423 Minden

Phone: +49571 887-0 | Fax: +49571 887-169

Email: [info.de@wago.com](mailto:info.de@wago.com) | Web: [www.wago.com](http://www.wago.com)

Do you have any questions about our products?

We are always happy to take your call at +49 (571) 887-44222.



<p><b>Item no.: 793-501/000-002</b> WMB marking card; as card; not stretchable; plain; snap-on type; yellow</p>	<p><a href="http://www.wago.com/793-501/000-002">www.wago.com/793-501/000-002</a></p>
<p><b>Item no.: 793-501/000-005</b> WMB marking card; as card; not stretchable; plain; snap-on type; red</p>	<p><a href="http://www.wago.com/793-501/000-005">www.wago.com/793-501/000-005</a></p>
<p><b>Item no.: 793-501/000-006</b> WMB marking card; as card; not stretchable; plain; snap-on type; blue</p>	<p><a href="http://www.wago.com/793-501/000-006">www.wago.com/793-501/000-006</a></p>
<p><b>Item no.: 793-501/000-007</b> WMB marking card; as card; not stretchable; plain; snap-on type; gray</p>	<p><a href="http://www.wago.com/793-501/000-007">www.wago.com/793-501/000-007</a></p>
<p><b>Item no.: 793-501/000-012</b> WMB marking card; as card; not stretchable; plain; snap-on type; orange</p>	<p><a href="http://www.wago.com/793-501/000-012">www.wago.com/793-501/000-012</a></p>
<p><b>Item no.: 793-501/000-017</b> WMB marking card; as card; not stretchable; plain; snap-on type; light green</p>	<p><a href="http://www.wago.com/793-501/000-017">www.wago.com/793-501/000-017</a></p>
<p><b>Item no.: 793-501/000-023</b> WMB marking card; as card; not stretchable; plain; snap-on type; green</p>	<p><a href="http://www.wago.com/793-501/000-023">www.wago.com/793-501/000-023</a></p>
<p><b>Item no.: 793-501/000-024</b> WMB marking card; as card; not stretchable; plain; snap-on type; violet</p>	<p><a href="http://www.wago.com/793-501/000-024">www.wago.com/793-501/000-024</a></p>
<p><b>Item no.: 793-5501</b> WMB marking card; as card; for terminal block width 5 - 17.5 mm; stretchable 5 - 5.2 mm; plain; snap-on type; white</p>	<p><a href="http://www.wago.com/793-5501">www.wago.com/793-5501</a></p>
<p><b>Item no.: 793-5501/000-002</b> WMB marking card; as card; for terminal block width 5 - 17.5 mm; stretchable 5 - 5.2 mm; plain; snap-on type; yellow</p>	<p><a href="http://www.wago.com/793-5501/000-002">www.wago.com/793-5501/000-002</a></p>
<p> <b>Item no.: 793-5501/000-005</b> WMB marking card; as card; for terminal block width 5 - 17.5 mm; stretchable 5 - 5.2 mm; plain; snap-on type; red</p>	<p><a href="http://www.wago.com/793-5501/000-005">www.wago.com/793-5501/000-005</a></p>
<p><b>Item no.: 793-5501/000-006</b> WMB marking card; as card; for terminal block width 5 - 17.5 mm; stretchable 5 - 5.2 mm; plain; snap-on type; blue</p>	<p><a href="http://www.wago.com/793-5501/000-006">www.wago.com/793-5501/000-006</a></p>
<p><b>Item no.: 793-5501/000-007</b> WMB marking card; as card; for terminal block width 5 - 17.5 mm; stretchable 5 - 5.2 mm; plain; snap-on type; gray</p>	<p><a href="http://www.wago.com/793-5501/000-007">www.wago.com/793-5501/000-007</a></p>
<p><b>Item no.: 793-5501/000-012</b></p>	

Subject to changes. Please also observe the further product documentation!





WMB marking card; as card; for terminal block width 5 - 17.5 mm; stretchable 5 - 5.2 mm; plain; snap-on type; orange

[www.wago.com/793-5501/000-012](http://www.wago.com/793-5501/000-012)

**Item no.: 793-5501/000-017**

WMB marking card; as card; for terminal block width 5 - 17.5 mm; stretchable 5 - 5.2 mm; plain; snap-on type; green

[www.wago.com/793-5501/000-017](http://www.wago.com/793-5501/000-017)

**Item no.: 793-5501/000-023**

WMB marking card; as card; for terminal block width 5 - 17.5 mm; stretchable 5 - 5.2 mm; plain; snap-on type; light green

[www.wago.com/793-5501/000-023](http://www.wago.com/793-5501/000-023)

**Item no.: 793-5501/000-024**

WMB marking card; as card; for terminal block width 5 - 17.5 mm; stretchable 5 - 5.2 mm; plain; snap-on type; violet

[www.wago.com/793-5501/000-024](http://www.wago.com/793-5501/000-024)

**Insulation stop**

**Item no.: 280-470**

Insulation stop; 0.08 - 0.2 mm<sup>2</sup> "s" (0.14 mm<sup>2</sup> "f-st"); 5 pieces/strip; white

[www.wago.com/280-470](http://www.wago.com/280-470)

**Item no.: 280-471**

Insulation stop; 0.25 - 0.5 mm<sup>2</sup>; 5 pieces/strip; light gray

[www.wago.com/280-471](http://www.wago.com/280-471)

**Item no.: 280-472**

Insulation stop; 0.75 - 1 mm<sup>2</sup>; 5 pieces/strip

[www.wago.com/280-472](http://www.wago.com/280-472)

**Downloads**

**Documentation**

**Additional Information**

Technical explanations	Apr 3, 2019	pdf 2.1 MB	Download
------------------------	-------------	---------------	----------

**CAD/CAE-Data**

**CAD data**

2D/3D Models 270-577	URL	Download
----------------------	-----	----------

**CAE data**

EPLAN Data Portal 270-577	URL	Download
---------------------------	-----	----------

WSCAD Universe 270-577	URL	Download
------------------------	-----	----------

Subject to changes. Please also observe the further product documentation!

WAGO Kontakttechnik GmbH & Co. KG  
 Hansastr. 27  
 32423 Minden  
 Phone: +49571 887-0 | Fax: +49571 887-169  
 Email: [info.de@wago.com](mailto:info.de@wago.com) | Web: [www.wago.com](http://www.wago.com)

Do you have any questions about our products?  
 We are always happy to take your call at +49 (571) 887-44222.

## Installation Notes

### Commoning

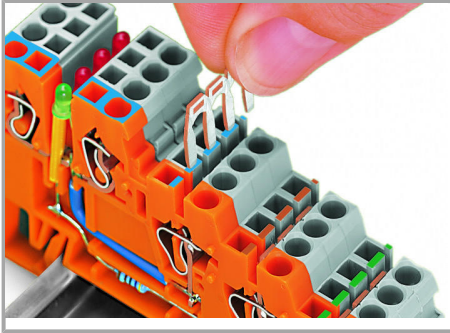

Inserting a jumper.

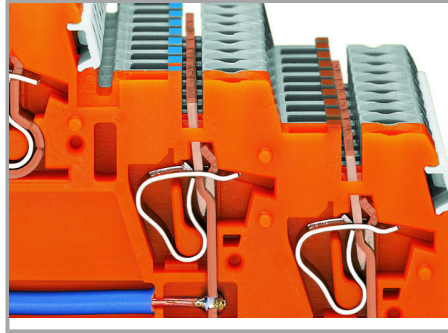

Commoning a supply voltage using uninsulated push-in type jumper bars, 2- to 9-way or 17-way (2 x 8 bits), depending on application.



Commoning signal level voltage via insulated push-in type jumper bars (870 Series) – 2- to 9-way, depending on application.

**Sensor LED terminal blocks cannot be commoned!**

### Marking

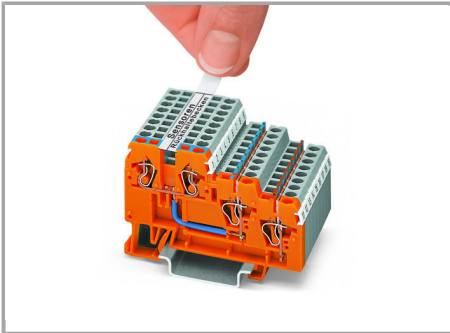

Marking strip (Item No. 709-196)

**Not suitable for LED terminal blocks!**

Subject to changes. Please also observe the further product documentation!