

## Data sheet | Item number: 261-429

2-conductor terminal strip; 9-pole; without push-buttons; with fixing flanges; for screw or similar mounting types; Fixing hole 3.2 mm Ø; 2.5 mm<sup>2</sup>; CAGE CLAMP®; 2,50 mm<sup>2</sup>; gray

[www.wago.com/261-429](http://www.wago.com/261-429)

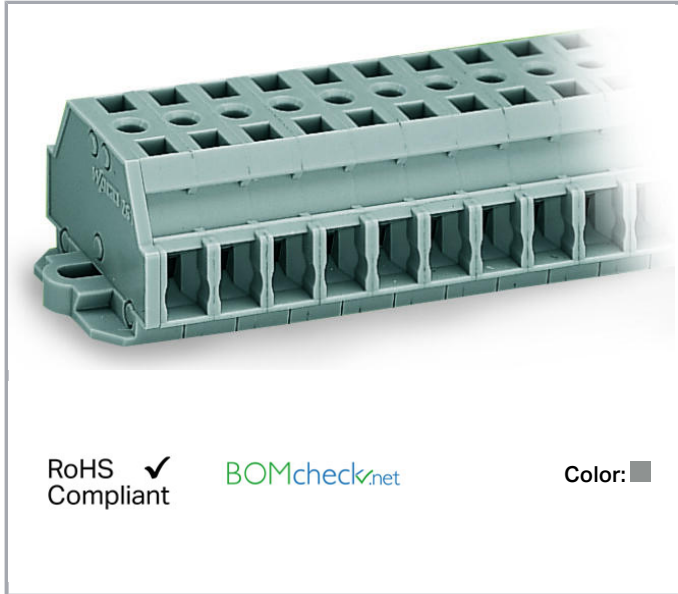

RoHS  Compliant

BOMcheck.net

Color: ■

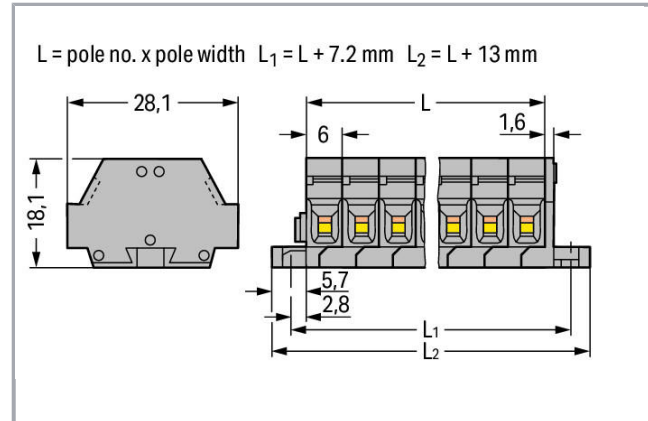

### Data

#### Electrical data

#### Ratings per IEC/EN 60664-1

Rated voltage (III / 3)	500 V
Rated impulse voltage (III / 3)	6 kV
Rated current	24 A
Legend (ratings)	(III / 3) ≙ Overvoltage category III / Pollution degree 3

#### Connection data

Connection technology	CAGE CLAMP®
Actuation type	Operating tool
Connectable conductor materials	Copper
Solid conductor	0.08 ... 2.5 mm <sup>2</sup> / 28 ... 14 AWG
Fine-stranded conductor	0.08 ... 2.5 mm <sup>2</sup> / 28 ... 14 AWG
Strip length	8 ... 9 mm / 0.31 ... 0.35 inch
No. of poles	9

Subject to changes. Please also observe the further product documentation!

WAGO Kontakttechnik GmbH & Co. KG  
Hansastr. 27  
32423 Minden  
Phone: +49571 887-0 | Fax: +49571 887-169  
Email: [info.de@wago.com](mailto:info.de@wago.com) | Web: [www.wago.com](http://www.wago.com)

Do you have any questions about our products?  
We are always happy to take your call at +49 (571) 887-44222.



Total number of connection points	18
Total number of potentials	9
Number of levels	1
Type of wiring	Side-entry wiring

### Geometrical Data

Width	67.6 mm / 2.661 inch
Height from the surface	18 mm / 0.709 inch
Depth	28 mm / 1.102 inch
Module width	6 mm / 0.236 inch

### Mechanical data

Design	horizontal
Mounting type	Mounting flange
Marking level	Side marking

### Material Data

Color	gray
Fire load	0.426 MJ
Weight	23.5 g

### Commercial data

Packaging type	BOX
Country of origin	DE
GTIN	4044918627702
Customs Tariff No.	85369010000

### Counterpart

### Compatible products

#### assembling

Subject to changes. Please also observe the further product documentation!

WAGO Kontakttechnik GmbH & Co. KG  
Hansastr. 27  
32423 Minden  
Phone: +49571 887-0 | Fax: +49571 887-169  
Email: [info.de@wago.com](mailto:info.de@wago.com) | Web: [www.wago.com](http://www.wago.com)

Do you have any questions about our products?  
We are always happy to take your call at +49 (571) 887-44222.

**Item no.: 209-137**

Mounting adapter; can be used as end plate; 6.5 mm wide; gray

[www.wago.com/209-137](http://www.wago.com/209-137)**tools****Item no.: 209-132**

Operating tool; for connecting comb-style jumper bar; 2-way; of insulating material

[www.wago.com/209-132](http://www.wago.com/209-132)**Item no.: 210-657**

Operating tool; Blade: 3.5 x 0.5 mm; with a partially insulated shaft; short

[www.wago.com/210-657](http://www.wago.com/210-657)**Item no.: 210-658**

Operating tool; Blade: 3.5 x 0.5 mm; with a partially insulated shaft; angled; short

[www.wago.com/210-658](http://www.wago.com/210-658)**Item no.: 210-720**

Operating tool; Blade: 3.5 x 0.5 mm; with a partially insulated shaft

[www.wago.com/210-720](http://www.wago.com/210-720)**Marking accessories****Item no.: 2009-145**

Mini-WSB Inline; for Smart Printer; 1700 pieces on roll; stretchable 5 - 5.2 mm; plain; snap-on type; white

[www.wago.com/2009-145](http://www.wago.com/2009-145)**Item no.: 2009-145/000-002**

Mini-WSB Inline; for Smart Printer; 1700 pieces on roll; stretchable 5 - 5.2 mm; plain; snap-on type; white

[www.wago.com/2009-145/000-002](http://www.wago.com/2009-145/000-002)**Item no.: 2009-145/000-005**

Mini-WSB Inline; for Smart Printer; 1700 pieces on roll; stretchable 5 - 5.2 mm; plain; snap-on type; red

[www.wago.com/2009-145/000-005](http://www.wago.com/2009-145/000-005)**Item no.: 2009-145/000-006**

Mini-WSB Inline; for Smart Printer; 1700 pieces on roll; stretchable 5 - 5.2 mm; plain; snap-on type; blue

[www.wago.com/2009-145/000-006](http://www.wago.com/2009-145/000-006)**Item no.: 2009-145/000-007**

Mini-WSB Inline; for Smart Printer; 1700 pieces on roll; stretchable 5 - 5.2 mm; plain; snap-on type; white

[www.wago.com/2009-145/000-007](http://www.wago.com/2009-145/000-007)**Item no.: 2009-145/000-012**

Mini-WSB Inline; for Smart Printer; 1700 pieces on roll; stretchable 5 - 5.2 mm; plain; snap-on type; orange

[www.wago.com/2009-145/000-012](http://www.wago.com/2009-145/000-012)**Item no.: 2009-145/000-023**

Mini-WSB Inline; for Smart Printer; 1700 pieces on roll; stretchable 5 - 5.2 mm; plain; snap-on type; green

[www.wago.com/2009-145/000-023](http://www.wago.com/2009-145/000-023)**Item no.: 2009-145/000-024**

Mini-WSB Inline; for Smart Printer; 1700 pieces on roll; stretchable 5 - 5.2 mm; plain; snap-on type; violet

[www.wago.com/2009-145/000-024](http://www.wago.com/2009-145/000-024)**Item no.: 248-501**

Miniature WSB Quick marking system; plain; Marker width 5 mm; 10 strips with 10 markers per card

[www.wago.com/248-501](http://www.wago.com/248-501)

Subject to changes. Please also observe the further product documentation!

WAGO Kontakttechnik GmbH &amp; Co. KG

Hansastr. 27

32423 Minden

Phone: +49571 887-0 | Fax: +49571 887-169

Email: [info.de@wago.com](mailto:info.de@wago.com) | Web: [www.wago.com](http://www.wago.com)

Do you have any questions about our products?

We are always happy to take your call at +49 (571) 887-44222.

**Item no.: 248-501/000-002**

Mini-WSB marking card; as card; not stretchable; plain; snap-on type; yellow

[www.wago.com/248-501/000-002](http://www.wago.com/248-501/000-002)

**Item no.: 248-501/000-005**

Mini-WSB marking card; as card; not stretchable; plain; snap-on type; red

[www.wago.com/248-501/000-005](http://www.wago.com/248-501/000-005)

**Item no.: 248-501/000-006**

Mini-WSB marking card; as card; not stretchable; plain; snap-on type; blue

[www.wago.com/248-501/000-006](http://www.wago.com/248-501/000-006)

**Item no.: 248-501/000-007**

Mini-WSB marking card; as card; not stretchable; plain; snap-on type; gray

[www.wago.com/248-501/000-007](http://www.wago.com/248-501/000-007)

**Item no.: 248-501/000-012**

Mini-WSB marking card; as card; not stretchable; plain; snap-on type; orange

[www.wago.com/248-501/000-012](http://www.wago.com/248-501/000-012)



**Item no.: 248-501/000-017**

Mini-WSB marking card; as card; not stretchable; plain; snap-on type; light green

[www.wago.com/248-501/000-017](http://www.wago.com/248-501/000-017)

**Item no.: 248-501/000-023**

Mini-WSB marking card; as card; not stretchable; plain; snap-on type; green

[www.wago.com/248-501/000-023](http://www.wago.com/248-501/000-023)

**Item no.: 248-501/000-024**

Mini-WSB marking card; as card; not stretchable; plain; snap-on type; violet

[www.wago.com/248-501/000-024](http://www.wago.com/248-501/000-024)

**ferrule**



**Item no.: 216-101**

Ferrule; Sleeve for 0.5 mm<sup>2</sup> / AWG 22; uninsulated; electro-tin plated

[www.wago.com/216-101](http://www.wago.com/216-101)

**Item no.: 216-102**

Ferrule; Sleeve for 0.75 mm<sup>2</sup> / AWG 20; uninsulated; electro-tin plated

[www.wago.com/216-102](http://www.wago.com/216-102)

**Item no.: 216-103**

Ferrule; Sleeve for 1 mm<sup>2</sup> / AWG 18; uninsulated; electro-tin plated

[www.wago.com/216-103](http://www.wago.com/216-103)



**Item no.: 216-104**

Ferrule; Sleeve for 1.5 mm<sup>2</sup> / AWG 16; uninsulated; electro-tin plated

[www.wago.com/216-104](http://www.wago.com/216-104)



**Item no.: 216-106**

Ferrule; Sleeve for 2.5 mm<sup>2</sup> / AWG 14; uninsulated; electro-tin plated

[www.wago.com/216-106](http://www.wago.com/216-106)

**Item no.: 216-121**

Ferrule; Sleeve for 0.5 mm<sup>2</sup> / AWG 22; uninsulated; electro-tin plated

[www.wago.com/216-121](http://www.wago.com/216-121)

**Item no.: 216-122**

Ferrule; Sleeve for 0.75 mm<sup>2</sup> / AWG 20; uninsulated; electro-tin plated

[www.wago.com/216-122](http://www.wago.com/216-122)

Subject to changes. Please also observe the further product documentation!

WAGO Kontakttechnik GmbH & Co. KG

Hansastr. 27

32423 Minden

Phone: +49571 887-0 | Fax: +49571 887-169

Email: [info.de@wago.com](mailto:info.de@wago.com) | Web: [www.wago.com](http://www.wago.com)

Do you have any questions about our products?

We are always happy to take your call at +49 (571) 887-44222.

	<b>Item no.: 216-123</b> Ferrule; Sleeve for 1 mm <sup>2</sup> / AWG 18; uninsulated; electro-tin plated	<a href="http://www.wago.com/216-123">www.wago.com/216-123</a>
	<b>Item no.: 216-124</b> Ferrule; Sleeve for 1.5 mm <sup>2</sup> / AWG 16; uninsulated; electro-tin plated	<a href="http://www.wago.com/216-124">www.wago.com/216-124</a>
	<b>Item no.: 216-131</b> Ferrule; Sleeve for 0.25 mm <sup>2</sup> / AWG 24; uninsulated; electro-tin plated	<a href="http://www.wago.com/216-131">www.wago.com/216-131</a>
	<b>Item no.: 216-132</b> Ferrule; Sleeve for 0.34 mm <sup>2</sup> / AWG 24; uninsulated; electro-tin plated	<a href="http://www.wago.com/216-132">www.wago.com/216-132</a>
	<b>Item no.: 216-151</b> Ferrule; Sleeve for 0.25 mm <sup>2</sup> / AWG 24; uninsulated; electro-tin plated	<a href="http://www.wago.com/216-151">www.wago.com/216-151</a>
	<b>Item no.: 216-152</b> Ferrule; Sleeve for 0.34 mm <sup>2</sup> / AWG 24; uninsulated; electro-tin plated	<a href="http://www.wago.com/216-152">www.wago.com/216-152</a>
	<b>Item no.: 216-201</b> Ferrule; Sleeve for 0.5 mm <sup>2</sup> / 20 AWG; insulated; electro-tin plated; white	<a href="http://www.wago.com/216-201">www.wago.com/216-201</a>
	<b>Item no.: 216-202</b> Ferrule; Sleeve for 0.75 mm <sup>2</sup> / 18 AWG; insulated; electro-tin plated; gray	<a href="http://www.wago.com/216-202">www.wago.com/216-202</a>
	<b>Item no.: 216-203</b> Ferrule; Sleeve for 1 mm <sup>2</sup> / AWG 18; insulated; electro-tin plated; red	<a href="http://www.wago.com/216-203">www.wago.com/216-203</a>
	<b>Item no.: 216-204</b> Ferrule; Sleeve for 1.5 mm <sup>2</sup> / AWG 16; insulated; electro-tin plated; black	<a href="http://www.wago.com/216-204">www.wago.com/216-204</a>
	<b>Item no.: 216-205</b> Ferrule; Sleeve for 2.08 mm <sup>2</sup> / AWG 14; insulated; electro-tin plated; yellow	<a href="http://www.wago.com/216-205">www.wago.com/216-205</a>
	<b>Item no.: 216-206</b> Ferrule; Sleeve for 2.5 mm <sup>2</sup> / AWG 14; insulated; electro-tin plated; blue	<a href="http://www.wago.com/216-206">www.wago.com/216-206</a>
	<b>Item no.: 216-221</b> Ferrule; Sleeve for 0.5 mm <sup>2</sup> / 20 AWG; insulated; electro-tin plated; white	<a href="http://www.wago.com/216-221">www.wago.com/216-221</a>
	<b>Item no.: 216-222</b> Ferrule; Sleeve for 0.75 mm <sup>2</sup> / 18 AWG; insulated; electro-tin plated; gray	<a href="http://www.wago.com/216-222">www.wago.com/216-222</a>
	<b>Item no.: 216-223</b> Ferrule; Sleeve for 1 mm <sup>2</sup> / AWG 18; insulated; electro-tin plated; red	<a href="http://www.wago.com/216-223">www.wago.com/216-223</a>
	<b>Item no.: 216-224</b> Ferrule; Sleeve for 1.5 mm <sup>2</sup> / AWG 16; insulated; electro-tin plated; black	<a href="http://www.wago.com/216-224">www.wago.com/216-224</a>
	<b>Item no.: 216-301</b> Ferrule; Sleeve for 0.25 mm <sup>2</sup> / AWG 24; insulated; electro-tin plated; yellow	<a href="http://www.wago.com/216-301">www.wago.com/216-301</a>
	<b>Item no.: 216-302</b> Ferrule; Sleeve for 0.34 mm <sup>2</sup> / 22 AWG; insulated; electro-tin plated; green	<a href="http://www.wago.com/216-302">www.wago.com/216-302</a>

Subject to changes. Please also observe the further product documentation!

Item no.: 216-321

Ferrule; Sleeve for 0.25 mm<sup>2</sup> / AWG 24; insulated; electro-tin plated; yellow

[www.wago.com/216-321](http://www.wago.com/216-321)

Item no.: 216-322

Ferrule; Sleeve for 0.34 mm<sup>2</sup> / 22 AWG; insulated; electro-tin plated; green

[www.wago.com/216-322](http://www.wago.com/216-322)

#### General accessories

Item no.: 209-123

Mounting foot with screw; can be screwed on terminal blocks with fixing flange; 6.4 mm wide; gray

[www.wago.com/209-123](http://www.wago.com/209-123)

#### Test Accessories

Item no.: 210-136

Test plug; 2 mm Ø; with 500 mm cable; red

[www.wago.com/210-136](http://www.wago.com/210-136)

#### Jumper



Item no.: 261-402

Comb-style jumper bar; insulated; 2-way; reduces conductor size to 1.5 mm; gray

[www.wago.com/261-402](http://www.wago.com/261-402)

## Downloads

### Documentation

#### Additional Information

Technical explanations

Apr 3, 2019

pdf  
2.1 MB

[Download](#)

## CAD/CAE-Data

### CAD data

2D/3D Models 261-429

[URL](#)

[Download](#)

### CAE data

EPLAN Data Portal 261-429

[URL](#)

[Download](#)

WSCAD Universe 261-429

[URL](#)

[Download](#)

## Installation Notes

### Inserting a conductor

Subject to changes. Please also observe the further product documentation!

WAGO Kontakttechnik GmbH & Co. KG

Hansastr. 27

32423 Minden

Phone: +49571 887-0 | Fax: +49571 887-169

Email: [info.de@wago.com](mailto:info.de@wago.com) | Web: [www.wago.com](http://www.wago.com)

Do you have any questions about our products?

We are always happy to take your call at +49 (571) 887-44222.

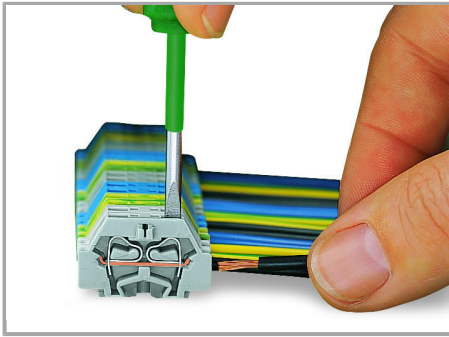

CAGE CLAMP® connection

Inserting a conductor.

With ferruled conductors, it is necessary to use a terminal block one size larger than the conductor's nominal cross-section.

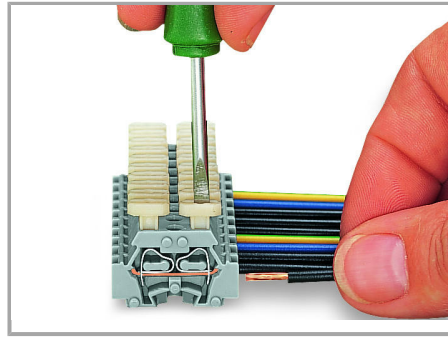

CAGE CLAMP® connection

Inserting a conductor via push-button.

#### Jumpered

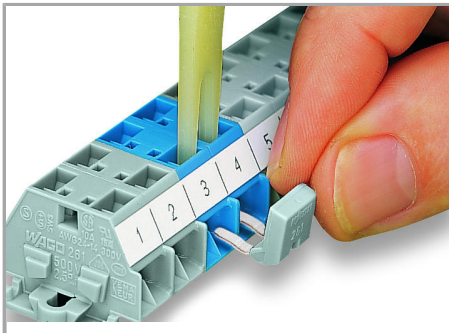

Commoning with comb-style jumper bar.

#### Testing

Subject to changes. Please also observe the further product documentation!

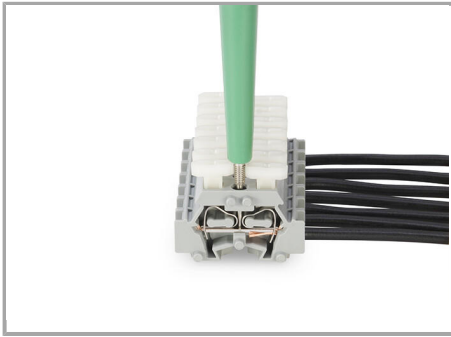

Testing with voltage tester.

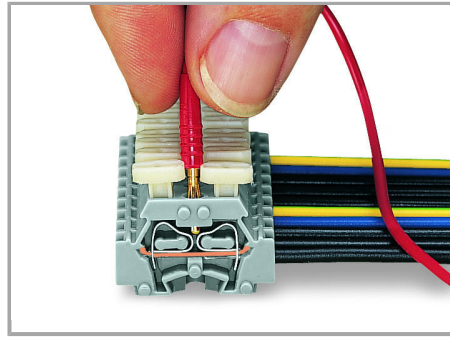

Testing with a 2 mm Ø test plug – touch contact.

### Assembly

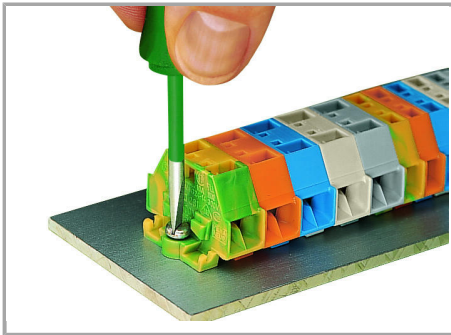

Mounting and securing a terminal strip directly to the plate via screw-type flanges.

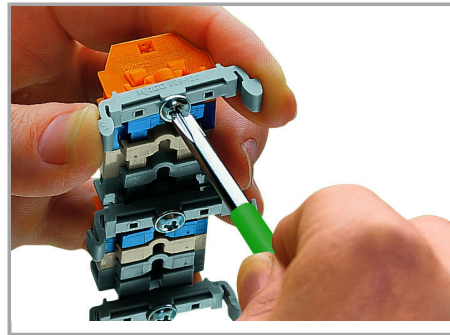

Terminal strip with mounting flanges – screwing a 209-123 Mounting Foot

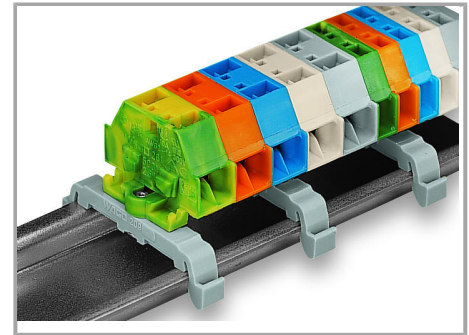

Terminal strip with mounting flanges on DIN-35 rail

(distance between mounting feet: approx. 25 ... 30 mm)

### Marking

Subject to changes. Please also observe the further product documentation!



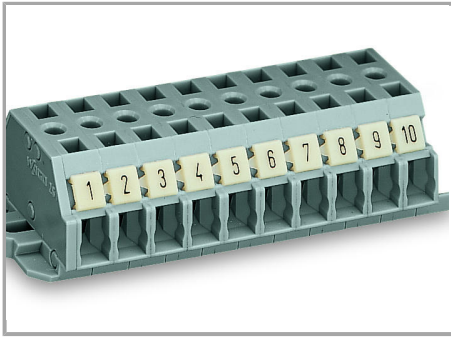

Terminal strip with marker slot for Mini-WSB  
Quick Marking System

Subject to changes. Please also observe the further product documentation!