

Data sheet | Item number: 254-812

Stackable 2-conductor PCB terminal block; 0.75 mm²; Pin spacing 7.5/7.62 mm; 1-pole; PUSH WIRE®; 0,75 mm²; dark gray

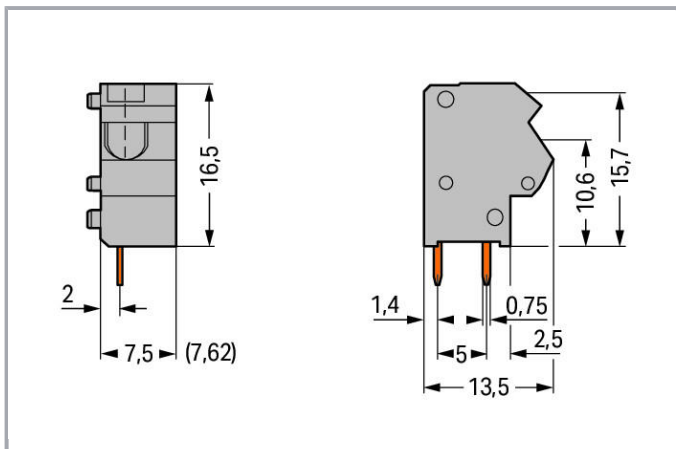

www.wago.com/254-812

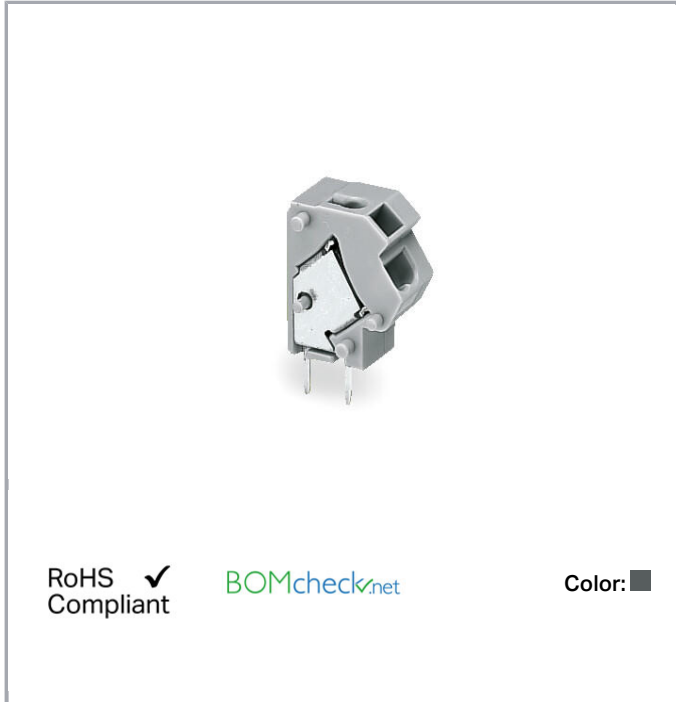

Item description

- Modular terminal blocks with screwdriver-actuated PUSH WIRE® for custom terminal strip assemblies

Subject to changes. Please also observe the further product documentation!

WAGO Kontakttechnik GmbH & Co. KG
Hansastr. 27
32423 Minden
Phone: +49571 887-0 | Fax: +49571 887-169
Email: info.de@wago.com | Web: www.wago.com

Do you have any questions about our products?
We are always happy to take your call at +49 (571) 887-44222.



- Push-in termination of solid and ferruled, fine-stranded conductors
- Test socket for 2mm Ø test plug
- Saves space on the PCB, just 8.9mm deep

Data

Electrical data

Ratings per IEC/EN 60664-1

| Ratings per | IEC/EN 60664-1 |
|---------------------------------|---|
| Rated voltage (III / 3) | 500 V |
| Rated impulse voltage (III / 3) | 6 kV |
| Rated voltage (III / 2) | 630 V |
| Rated impulse voltage (III / 2) | 6 kV |
| Rated voltage (II / 2) | 1000 V |
| Rated impulse voltage (II / 2) | 6 kV |
| Rated current | 10 A |
| Legend (ratings) | (III / 2) ≙ Overvoltage category III / Pollution degree 2 |

Approvals per UL 1059

| | |
|--------------------------------|---------|
| Rated voltage UL (Use Group B) | 300 V |
| Rated current UL (Use Group B) | 10 A |
| Rated voltage UL (Use Group D) | 300 V |
| Rated current UL (Use Group D) | 10 A |
| Approvals per | UL 1059 |

Approvals per CSA

| | |
|---------------------------------|-------|
| Rated voltage CSA (Use Group B) | 300 V |
| Rated current CSA (Use Group B) | 10 A |
| Rated voltage CSA (Use Group D) | 300 V |
| Rated current CSA (Use Group D) | 10 A |

Connection data

| | |
|-----------------------|---|
| Connection technology | PUSH WIRE® |
| Actuation type | Operating tool |
| Solid conductor | 0.25 ... 0.75 mm ² / 22 ... 18 AWG |
| Strip length | 10 ... 12 mm / 0.39 ... 0.47 inch |

Subject to changes. Please also observe the further product documentation!



| | |
|-----------------------------------|-----|
| Conductor entry angle to the PCB | 45° |
| No. of poles | 1 |
| Total number of connection points | 2 |
| Total number of potentials | 1 |
| Number of connection types | 1 |
| Number of levels | 1 |

Geometrical Data

| | |
|-----------------------------------|------------------------------|
| Pin spacing | 7.5/7.62 mm / 0.295/0.3 inch |
| Width | 9.2 mm / 0.362 inch |
| Height | 20.5 mm / 0.807 inch |
| Height from the surface | 16.5 mm / 0.65 inch |
| Depth | 13.5 mm / 0.531 inch |
| Solder pin length | 4 mm |
| Solder pin dimensions | 0.5 x 0.75 mm |
| Drilled hole diameter (tolerance) | 1.1 (+0.1) mm |

PCB contact

| | |
|-------------------------------------|------------------------------------|
| PCB contact | THT |
| Solder pin arrangement | within the terminal block, in line |
| Number of solder pins per potential | 2 |

Material Data

| | |
|-----------------------------|--|
| Color | dark gray |
| Material group | I |
| Insulating material | Polyamide 66 (PA 66) |
| Flammability class per UL94 | V0 |
| Clamping spring material | Chrome nickel spring steel (CrNi) |
| Contact material | Electrolytic copper (E _{Cu}) |
| Contact plating | tin-plated |
| Fire load | 0.026 MJ |
| Weight | 1.4 g |

Environmental Requirements

| | |
|-------------------------|-----------------|
| Limit temperature range | -60 ... +105 °C |
|-------------------------|-----------------|



Subject to changes. Please also observe the further product documentation!

Commercial data



| | |
|--------------------|---------------------|
| Product Group | 4 (Printed Circuit) |
| Packaging type | BOX |
| Country of origin | PL |
| GTIN | 4044918941785 |
| Customs Tariff No. | 85369010000 |

Approvals / Certificates

Country specific Approvals

| Logo | Approval | Additional Approval Text | Certificate name |
|--|---------------------------------|--------------------------|------------------|
|  | CCA DEKRA Certification B.V. | EN 60947 | NTR NL 7375 |
|  | CSA DEKRA Certification B.V. | C22.2 | LR 18677- 38 |

Ship Approvals

| Logo | Approval | Additional Approval Text | Certificate name |
|--|--|--------------------------|--------------------------|
|  | ABS American Bureau of Shipping | - | 14- HG1241537- PDA |
|  | DNV GL Det Norske Veritas, Germanischer Lloyd | - | TAE000016Z |

UL-Approvals









| Logo | Approval | Additional Approval Text | Certificate name |
|--|--------------------------------------|--------------------------|------------------|
|  | UR Underwriters Laboratories Inc. | UL 1059 | E45172 sec. 6 |

Subject to changes. Please also observe the further product documentation!

Counterpart

Compatible products

ferrule

| | | |
|--|--|--|
| | Item no.: 216-101 Ferrule; Sleeve for 0.5 mm ² / AWG 22; uninsulated; electro-tin plated | www.wago.com/216-101 |
|  | Item no.: 216-102 Ferrule; Sleeve for 0.75 mm ² / AWG 20; uninsulated; electro-tin plated | www.wago.com/216-102 |
| | Item no.: 216-103 Ferrule; Sleeve for 1 mm ² / AWG 18; uninsulated; electro-tin plated | www.wago.com/216-103 |
| | Item no.: 216-104 Ferrule; Sleeve for 1.5 mm ² / AWG 16; uninsulated; electro-tin plated | www.wago.com/216-104 |
|  | Item no.: 216-121 Ferrule; Sleeve for 0.5 mm ² / AWG 22; uninsulated; electro-tin plated | www.wago.com/216-121 |
| | Item no.: 216-122 Ferrule; Sleeve for 0.75 mm ² / AWG 20; uninsulated; electro-tin plated | www.wago.com/216-122 |
| | Item no.: 216-123 Ferrule; Sleeve for 1 mm ² / AWG 18; uninsulated; electro-tin plated | www.wago.com/216-123 |
|  | Item no.: 216-124 Ferrule; Sleeve for 1.5 mm ² / AWG 16; uninsulated; electro-tin plated | www.wago.com/216-124 |
|  | Item no.: 216-141 Ferrule; Sleeve for 0.5 mm ² / 20 AWG; uninsulated; electro-tin plated; electrolytic copper; gastight crimped; acc. to DIN 46228, Part 1/08.92 | www.wago.com/216-141 |
|  | Item no.: 216-142 Ferrule; Sleeve for 0.75 mm ² / 18 AWG; uninsulated; electro-tin plated; electrolytic copper; gastight crimped; acc. to DIN 46228, Part 1/08.92 | www.wago.com/216-142 |
|  | Item no.: 216-143 Ferrule; Sleeve for 1 mm ² / AWG 18; uninsulated; electro-tin plated; electrolytic copper; gastight crimped; acc. to DIN 46228, Part 1/08.92 | www.wago.com/216-143 |
|  | Item no.: 216-144 Ferrule; Sleeve for 1.5 mm ² / AWG 16; uninsulated; electro-tin plated; electrolytic copper; gastight crimped; acc. to DIN 46228, Part 1/08.92 | www.wago.com/216-144 |
|  | Item no.: 216-201 Ferrule; Sleeve for 0.5 mm ² / 20 AWG; insulated; electro-tin plated; white | www.wago.com/216-201 |
| | Item no.: 216-202 Ferrule; Sleeve for 0.75 mm ² / 18 AWG; insulated; electro-tin plated; gray | www.wago.com/216-202 |
| | Item no.: 216-203 | |

Subject to changes. Please also observe the further product documentation!

Ferrule; Sleeve for 1 mm² / AWG 18; insulated; electro-tin plated; redwww.wago.com/216-203**Item no.: 216-204**Ferrule; Sleeve for 1.5 mm² / AWG 16; insulated; electro-tin plated; blackwww.wago.com/216-204**Item no.: 216-221**Ferrule; Sleeve for 0.5 mm² / 20 AWG; insulated; electro-tin plated; whitewww.wago.com/216-221**Item no.: 216-222**Ferrule; Sleeve for 0.75 mm² / 18 AWG; insulated; electro-tin plated; graywww.wago.com/216-222**Item no.: 216-223**Ferrule; Sleeve for 1 mm² / AWG 18; insulated; electro-tin plated; redwww.wago.com/216-223**Item no.: 216-224**Ferrule; Sleeve for 1.5 mm² / AWG 16; insulated; electro-tin plated; blackwww.wago.com/216-224**Item no.: 216-241**Ferrule; Sleeve for 0.5 mm² / 20 AWG; insulated; electro-tin plated; electrolytic copper; gastight crimped; acc. to DIN 46228, Part 4/09.90; whitewww.wago.com/216-241**Item no.: 216-242**Ferrule; Sleeve for 0.75 mm² / 18 AWG; insulated; electro-tin plated; electrolytic copper; gastight crimped; acc. to DIN 46228, Part 4/09.90; graywww.wago.com/216-242**Item no.: 216-243**Ferrule; Sleeve for 1 mm² / AWG 18; insulated; electro-tin plated; electrolytic copper; gastight crimped; acc. to DIN 46228, Part 4/09.90; redwww.wago.com/216-243**Item no.: 216-244**Ferrule; Sleeve for 1.5 mm² / AWG 16; insulated; electro-tin plated; electrolytic copper; gastight crimped; acc. to DIN 46228, Part 4/09.90; blackwww.wago.com/216-244**Item no.: 216-262**Ferrule; Sleeve for 0.75 mm² / 18 AWG; insulated; electro-tin plated; electrolytic copper; gastight crimped; acc. to DIN 46228, Part 4/09.90; graywww.wago.com/216-262**Item no.: 216-263**Ferrule; Sleeve for 1 mm² / AWG 18; insulated; electro-tin plated; electrolytic copper; gastight crimped; acc. to DIN 46228, Part 4/09.90; redwww.wago.com/216-263**Item no.: 216-264**Ferrule; Sleeve for 1.5 mm² / AWG 16; insulated; electro-tin plated; electrolytic copper; gastight crimped; acc. to DIN 46228, Part 4/09.90; blackwww.wago.com/216-264**Item no.: 216-284**Ferrule; Sleeve for 1.5 mm² / AWG 16; insulated; electro-tin plated; electrolytic copper; gastight crimped; acc. to DIN 46228, Part 4/09.90; blackwww.wago.com/216-284**End plate****Item no.: 254-200**

End plate; 1 mm thick; snap-fit type; dark gray

www.wago.com/254-200**Test Accessories****Item no.: 210-136**

Test plug; 2 mm Ø; with 500 mm cable; red

www.wago.com/210-136

Subject to changes. Please also observe the further product documentation!

WAGO Kontakttechnik GmbH & Co. KG

Hansastr. 27

32423 Minden

Phone: +49571 887-0 | Fax: +49571 887-169

Email: info.de@wago.com | Web: www.wago.com

Do you have any questions about our products?

We are always happy to take your call at +49 (571) 887-44222.



Downloads

Documentation

Additional Information

| | | | |
|------------------------|-------------|---------------|----------|
| Technical explanations | Apr 3, 2019 | pdf 3.6 MB | Download |
|------------------------|-------------|---------------|----------|

CAD/CAE-Data

CAE data

| | | |
|---------------------------|-----|----------|
| EPLAN Data Portal 254-812 | URL | Download |
|---------------------------|-----|----------|

PCB Design

| | | |
|------------------------------|-----|----------|
| Symbol and Footprint 254-812 | URL | Download |
|------------------------------|-----|----------|

CAX data for your PCB design, consisting of "schematic symbols and PCB footprints", allow easy integration of the WAGO component into your development environment.

Supported formats:

- Accel EDA 14 & 15
- Altium 6 to current version
- Cadence Allegro
- DesignSpark
- Eagle Libraries
- KiCad
- Mentor Graphics BoardStation
- Mentor Graphics Design Architect
- Mentor Graphics Design Expedition 99 and 2000
- OrCAD 9.X PCB and Capture
- PADS PowerPCB 3, 3.5, 4.X, and 5.X
- PADS PowerPCB and PowerLogic 3.0
- PCAD 2000, 2001, 2002, 2004, and 2006
- Pulsonix 8.5 or newer
- STL
- 3D STEP
- TARGET 3001!
- View Logic ViewDraw
- Quadcept
- Zuken CadStar 3 and 4

Subject to changes. Please also observe the further product documentation!

WAGO Kontakttechnik GmbH & Co. KG
Hansastr. 27
32423 Minden
Phone: +49571 887-0 | Fax: +49571 887-169
Email: info.de@wago.com | Web: www.wago.com

Do you have any questions about our products?
We are always happy to take your call at +49 (571) 887-44222.

- Zuken CR-5000 and CR-8000

PCB Component Libraries (EDA), PCB CAD Library Ultra Librarian

Installation Notes

Inserting a conductor

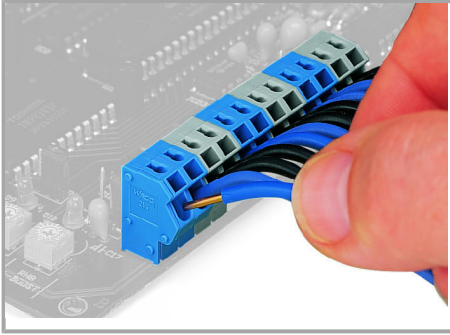

Inserting a solid conductor via push-in termination.

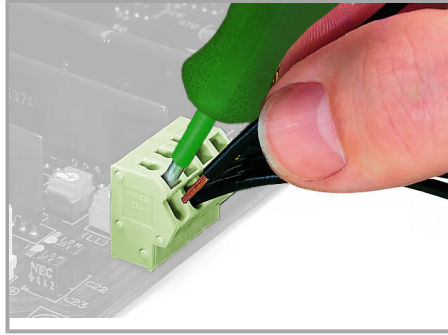

Inserting a tip-bonded conductor via screwdriver.

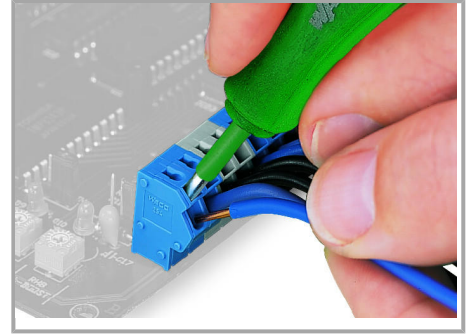

Removing a conductor.

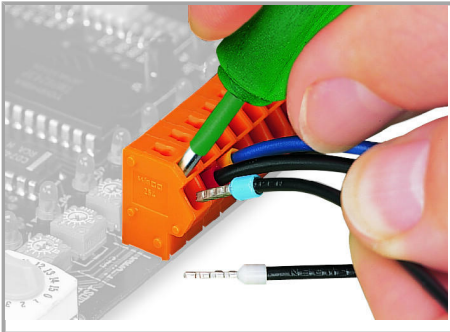

Inserting/removing a ferruled conductor.

Marking

Subject to changes. Please also observe the further product documentation!

WAGO Kontakttechnik GmbH & Co. KG
Hansastr. 27
32423 Minden
Phone: +49571 887-0 | Fax: +49571 887-169
Email: info.de@wago.com | Web: www.wago.com

Do you have any questions about our products?
We are always happy to take your call at +49 (571) 887-44222.



Labeling via self-adhesive marking strips.



Labeling via factory direct marking.

Testing

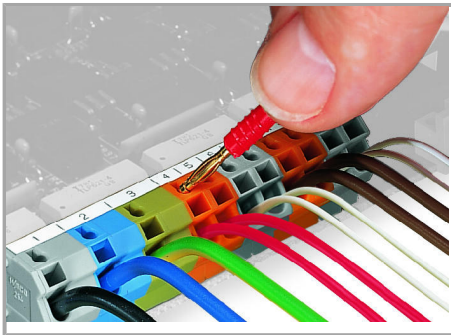

Testing with 2 mm Ø test plug.

Assembly

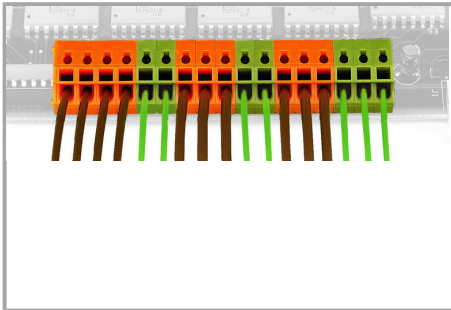

Mixed terminal strips can be assembled using different housing colors for the formation of groups.

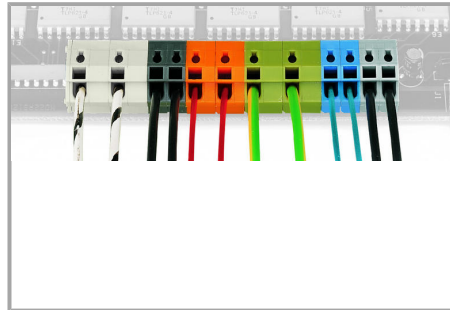

Mixed terminal strips can be assembled using different pin spacing and housing colors for the formation of groups.

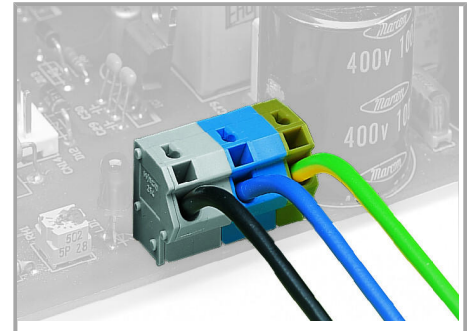

Application example: field-wiring terminal strip

Subject to changes. Please also observe the further product documentation!