

Data sheet | Item number: 236-208

PCB terminal block; 2.5 mm<sup>2</sup>; Pin spacing 7.5/7.62 mm; 8-pole; CAGE CLAMP®; commoning option; 2,50 mm<sup>2</sup>; gray



[www.wago.com/236-208](http://www.wago.com/236-208)



RoHS  Compliant

[BOMcheck.net](https://www.bomcheck.net)

Color: ■

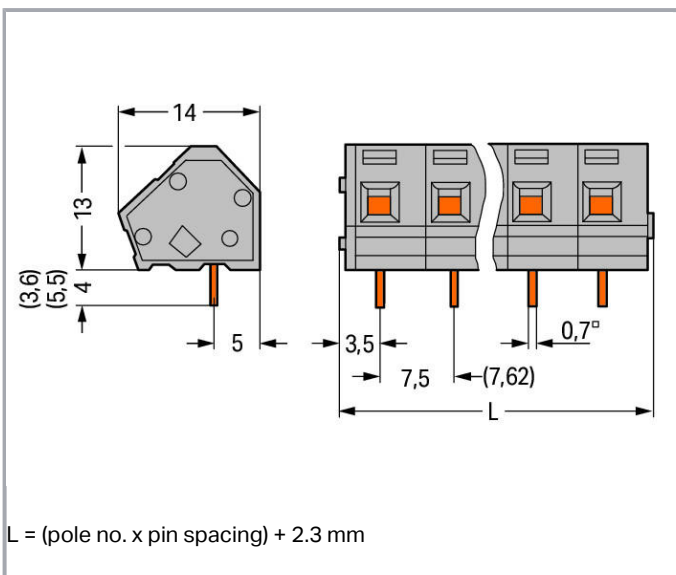

Subject to changes. Please also observe the further product documentation!

WAGO Kontakttechnik GmbH & Co. KG  
Hansastr. 27  
32423 Minden  
Phone: +49571 887-0 | Fax: +49571 887-169  
Email: [info.de@wago.com](mailto:info.de@wago.com) | Web: [www.wago.com](http://www.wago.com)

Do you have any questions about our products?  
We are always happy to take your call at +49 (571) 887-44222.



## Item description

- PCB terminal strips with CAGE CLAMP<sup>®</sup> connection and screwdriver actuation parallel or perpendicular to conductor entry
- Versions with Ex approval
- Mixed-color PCB terminal strips from factory
- Operating tools for factory wiring
- 45° conductor entry angle permits a wide range of applications and wiring options
- Set to metric or inch pin spacing by compressing PCB terminal strips or pulling them apart

## Data

### Electrical data

#### Ratings per IEC/EN 60664-1

| Ratings per                     | IEC/EN 60664-1   |
|---------------------------------|--|
| Rated voltage (III / 3)         | 400 V  |
| Rated impulse voltage (III / 3) | 6 kV   |
| Rated voltage (III / 2)         | 630 V  |
| Rated impulse voltage (III / 2) | 6 kV   |
| Rated voltage (II / 2)          | 1000 V   |
| Rated impulse voltage (II / 2)  | 6 kV   |
| Rated current                   | 24 A   |
| Legend (ratings)                | (III / 2) $\triangleq$ Overvoltage category III / Pollution degree 2 |

#### Approvals per UL 1059

|                                |         |
|--------------------------------|---------|
| Rated voltage UL (Use Group B) | 300 V   |
| Rated current UL (Use Group B) | 15 A    |
| Rated voltage UL (Use Group D) | 300 V   |
| Rated current UL (Use Group D) | 10 A    |
| Approvals per                  | UL 1059 |

#### Approvals per CSA

|                                 |       |
|---------------------------------|-------|
| Rated voltage CSA (Use Group B) | 300 V |
| Rated current CSA (Use Group B) | 15 A  |
| Rated voltage CSA (Use Group D) | 300 V |
| Rated current CSA (Use Group D) | 10 A  |

Subject to changes. Please also observe the further product documentation!



## Connection data

|   |  |
|---|--|
| Connection technology                                       | CAGE CLAMP®                                  |
| Actuation type  | Operating tool                               |
| Solid conductor   | 0.08 ... 2.5 mm <sup>2</sup> / 28 ... 12 AWG |
| Fine-stranded conductor                                     | 0.08 ... 2.5 mm <sup>2</sup> / 28 ... 12 AWG |
| Fine-stranded conductor with ferrule with plastic collar    | 0.25 ... 1.5 mm <sup>2</sup>                 |
| Fine-stranded conductor with ferrule without plastic collar | 0.25 ... 1.5 mm <sup>2</sup>                 |
| Strip length  | 5 ... 6 mm / 0.2 ... 0.24 inch               |
| Conductor entry angle to the PCB                            | 45°  |
| No. of poles  | 8  |
| Total number of connection points                           | 8  |
| Total number of potentials                                  | 8  |
| Number of connection types                                  | 1  |
| Number of levels  | 1  |
| Note (conductor cross-section)                              | 12 AWG: THHN, THWN                           |

## Geometrical Data

|                                   |                              |
|-----------------------------------|------------------------------|
| Pin spacing                       | 7.5/7.62 mm / 0.295/0.3 inch |
| Width                             | 62.3 mm / 2.453 inch         |
| Height                            | 17 mm / 0.669 inch           |
| Height from the surface           | 13 mm / 0.512 inch           |
| Depth                             | 14 mm / 0.551 inch           |
| Solder pin length                 | 4 mm                         |
| Solder pin dimensions             | 0.7 x 0.7 mm                 |
| Drilled hole diameter (tolerance) | 1.1 <sup>(+0.1)</sup> mm     |

## PCB contact

|                                     |   |
|-------------------------------------|---|
| PCB contact                         | THT                                     |
| Solder pin arrangement              | over the entire terminal strip, in line |
| Number of solder pins per potential | 1                                       |

## Material Data

|                     |                      |
|---------------------|----------------------|
| Color               | gray                 |
| Material group      | I                    |
| Insulating material | Polyamide 66 (PA 66) |

Subject to changes. Please also observe the further product documentation!

|                             |  |
|-----------------------------|--|
| Flammability class per UL94 | V0                                     |
| Clamping spring material    | Chrome nickel spring steel (CrNi)      |
| Contact material            | Electrolytic copper (E <sub>Cu</sub> ) |
| Contact plating             | tin-plated                             |
| Fire load                   | 0.156 MJ                               |
| Weight                      | 8.6 g                                  |

## Environmental Requirements





|                         |                 |
|-------------------------|-----------------|
| Limit temperature range | -60 ... +105 °C |
|-------------------------|-----------------|

## Commercial data

|                    |                     |
|--------------------|---------------------|
| Product Group      | 4 (Printed Circuit) |
| Packaging type     | BOX                 |
| Country of origin  | CH                  |
| GTIN               | 4044918768016       |
| Customs Tariff No. | 8536901000          |

## Approvals / Certificates

### Country specific Approvals

| Logo   | Approval                        | Additional Approval Text | Certificate name |
|--|---------------------------------|--------------------------|------------------|
|  | CCA<br>DEKRA Certification B.V. | EN 60947                 | NTR NL-7109      |
|  | CCA<br>DEKRA Certification B.V. | EN 60998                 | NTR NL-7195      |
|  | CCA<br>DEKRA Certification B.V. | EN 60947                 | 2168090.01       |
|  | CSA<br>DEKRA Certification B.V. | C22.2 No. 158            | 1673957          |

### Ship Approvals

Subject to changes. Please also observe the further product documentation!

| Logo   | Approval  | Additional Approval Text | Certificate name |
|--|---|--------------------------|------------------|
|  | <b>DNV GL</b><br>Det Norske Veritas, Germanischer Lloyd | -                        | TAE000016Z       |

#### UL-Approvals

| Logo   | Approval                                    | Additional Approval Text | Certificate name  |
|--|---|--------------------------|-------------------|
|  | <b>UR</b><br>Underwriters Laboratories Inc. | UL 1059                  | E45172,<br>sec. 6 |





#### Counterpart

#### Compatible products

#### Marking accessories

|  |  |
|--|--|
| <b>Item no.: 210-332/750-020</b><br>Marking strips; as a DIN A4 sheet; MARKED; 1-20 (80x); Height of marker strip: 3 mm; Strip length 182 mm; Horizontal marking; Self-adhesive; white | <a href="http://www.wago.com/210-332/750-020">www.wago.com/210-332/750-020</a> |
| <b>Item no.: 210-332/762-020</b><br>Marking strips; as a DIN A4 sheet; MARKED; 1-20 (80x); Height of marker strip: 3 mm; Strip length 182 mm; Horizontal marking; Self-adhesive; white | <a href="http://www.wago.com/210-332/762-020">www.wago.com/210-332/762-020</a> |

#### tools

|   |  |
|---|--|
|  <b>Item no.: 210-657</b><br>Operating tool; Blade: 3.5 x 0.5 mm; with a partially insulated shaft; short | <a href="http://www.wago.com/210-657">www.wago.com/210-657</a> |
| <b>Item no.: 210-658</b><br>Operating tool; Blade: 3.5 x 0.5 mm; with a partially insulated shaft; angled; short  | <a href="http://www.wago.com/210-658">www.wago.com/210-658</a> |
|  <b>Item no.: 210-720</b><br>Operating tool; Blade: 3.5 x 0.5 mm; with a partially insulated shaft        | <a href="http://www.wago.com/210-720">www.wago.com/210-720</a> |
|  <b>Item no.: 236-332</b><br>Operating tool; natural  | <a href="http://www.wago.com/236-332">www.wago.com/236-332</a> |
|  <b>Item no.: 236-335</b><br>Operating tool   | <a href="http://www.wago.com/236-335">www.wago.com/236-335</a> |

Subject to changes. Please also observe the further product documentation!

---

**Test Accessories**

---

**Item no.: 231-125**  
Testing plug module with contact stud; Pin spacing 7.62 mm / 0.3 in; 2,50 mm<sup>2</sup>; orange [www.wago.com/231-125](http://www.wago.com/231-125)

**Item no.: 231-161**  
Testing plug module with contact stud; for 236 Series; Pin spacing 7.5 mm / 0.295 in [www.wago.com/231-161](http://www.wago.com/231-161)

---

**ferrule**

---

**Item no.: 216-101**  
Ferrule; Sleeve for 0.5 mm<sup>2</sup> / AWG 22; uninsulated; electro-tin plated [www.wago.com/216-101](http://www.wago.com/216-101)

**Item no.: 216-102**  
Ferrule; Sleeve for 0.75 mm<sup>2</sup> / AWG 20; uninsulated; electro-tin plated [www.wago.com/216-102](http://www.wago.com/216-102)

**Item no.: 216-103**  
Ferrule; Sleeve for 1 mm<sup>2</sup> / AWG 18; uninsulated; electro-tin plated [www.wago.com/216-103](http://www.wago.com/216-103)

**Item no.: 216-104**  
Ferrule; Sleeve for 1.5 mm<sup>2</sup> / AWG 16; uninsulated; electro-tin plated [www.wago.com/216-104](http://www.wago.com/216-104)

**Item no.: 216-121**  
Ferrule; Sleeve for 0.5 mm<sup>2</sup> / AWG 22; uninsulated; electro-tin plated [www.wago.com/216-121](http://www.wago.com/216-121)

**Item no.: 216-122**  
Ferrule; Sleeve for 0.75 mm<sup>2</sup> / AWG 20; uninsulated; electro-tin plated [www.wago.com/216-122](http://www.wago.com/216-122)



**Item no.: 216-123**  
Ferrule; Sleeve for 1 mm<sup>2</sup> / AWG 18; uninsulated; electro-tin plated [www.wago.com/216-123](http://www.wago.com/216-123)

**Item no.: 216-124**  
Ferrule; Sleeve for 1.5 mm<sup>2</sup> / AWG 16; uninsulated; electro-tin plated [www.wago.com/216-124](http://www.wago.com/216-124)

**Item no.: 216-131**  
Ferrule; Sleeve for 0.25 mm<sup>2</sup> / AWG 24; uninsulated; electro-tin plated [www.wago.com/216-131](http://www.wago.com/216-131)



**Item no.: 216-132**  
Ferrule; Sleeve for 0.34 mm<sup>2</sup> / AWG 24; uninsulated; electro-tin plated [www.wago.com/216-132](http://www.wago.com/216-132)



**Item no.: 216-141**  
Ferrule; Sleeve for 0.5 mm<sup>2</sup> / 20 AWG; uninsulated; electro-tin plated; electrolytic copper; gastight crimped; acc. to DIN 46228, Part 1/08.92 [www.wago.com/216-141](http://www.wago.com/216-141)



**Item no.: 216-142**  
Ferrule; Sleeve for 0.75 mm<sup>2</sup> / 18 AWG; uninsulated; electro-tin plated; electrolytic copper; gastight crimped; acc. to DIN 46228, Part 1/08.92 [www.wago.com/216-142](http://www.wago.com/216-142)



















**Item no.: 216-143**  
Ferrule; Sleeve for 1 mm<sup>2</sup> / AWG 18; uninsulated; electro-tin plated; electrolytic copper; gastight crimped; acc. to DIN 46228, Part 1/08.92 [www.wago.com/216-143](http://www.wago.com/216-143)



**Item no.: 216-144**  
Ferrule; Sleeve for 1.5 mm<sup>2</sup> / AWG 16; uninsulated; electro-tin plated; electrolytic copper; gastight crimped; acc. to DIN 46228, Part 1/08.92 [www.wago.com/216-144](http://www.wago.com/216-144)

**Item no.: 216-151**  
Ferrule; Sleeve for 0.25 mm<sup>2</sup> / AWG 24; uninsulated; electro-tin plated [www.wago.com/216-151](http://www.wago.com/216-151)

Subject to changes. Please also observe the further product documentation!

|  |  |  |
|--|--|--|
|    | <b>Item no.: 216-152</b><br>Ferrule; Sleeve for 0.34 mm <sup>2</sup> / AWG 24; uninsulated; electro-tin plated   | <a href="http://www.wago.com/216-152">www.wago.com/216-152</a> |
|    | <b>Item no.: 216-201</b><br>Ferrule; Sleeve for 0.5 mm <sup>2</sup> / 20 AWG; insulated; electro-tin plated; white   | <a href="http://www.wago.com/216-201">www.wago.com/216-201</a> |
|    | <b>Item no.: 216-202</b><br>Ferrule; Sleeve for 0.75 mm <sup>2</sup> / 18 AWG; insulated; electro-tin plated; gray   | <a href="http://www.wago.com/216-202">www.wago.com/216-202</a> |
|    | <b>Item no.: 216-203</b><br>Ferrule; Sleeve for 1 mm <sup>2</sup> / AWG 18; insulated; electro-tin plated; red   | <a href="http://www.wago.com/216-203">www.wago.com/216-203</a> |
|    | <b>Item no.: 216-204</b><br>Ferrule; Sleeve for 1.5 mm <sup>2</sup> / AWG 16; insulated; electro-tin plated; black   | <a href="http://www.wago.com/216-204">www.wago.com/216-204</a> |
|    | <b>Item no.: 216-221</b><br>Ferrule; Sleeve for 0.5 mm <sup>2</sup> / 20 AWG; insulated; electro-tin plated; white   | <a href="http://www.wago.com/216-221">www.wago.com/216-221</a> |
|    | <b>Item no.: 216-222</b><br>Ferrule; Sleeve for 0.75 mm <sup>2</sup> / 18 AWG; insulated; electro-tin plated; gray   | <a href="http://www.wago.com/216-222">www.wago.com/216-222</a> |
|    | <b>Item no.: 216-223</b><br>Ferrule; Sleeve for 1 mm <sup>2</sup> / AWG 18; insulated; electro-tin plated; red   | <a href="http://www.wago.com/216-223">www.wago.com/216-223</a> |
|    | <b>Item no.: 216-224</b><br>Ferrule; Sleeve for 1.5 mm <sup>2</sup> / AWG 16; insulated; electro-tin plated; black   | <a href="http://www.wago.com/216-224">www.wago.com/216-224</a> |
|   | <b>Item no.: 216-241</b><br>Ferrule; Sleeve for 0.5 mm <sup>2</sup> / 20 AWG; insulated; electro-tin plated; electrolytic copper; gastight crimped; acc. to DIN 46228, Part 4/09.90; white | <a href="http://www.wago.com/216-241">www.wago.com/216-241</a> |
|  | <b>Item no.: 216-242</b><br>Ferrule; Sleeve for 0.75 mm <sup>2</sup> / 18 AWG; insulated; electro-tin plated; electrolytic copper; gastight crimped; acc. to DIN 46228, Part 4/09.90; gray | <a href="http://www.wago.com/216-242">www.wago.com/216-242</a> |
|  | <b>Item no.: 216-243</b><br>Ferrule; Sleeve for 1 mm <sup>2</sup> / AWG 18; insulated; electro-tin plated; electrolytic copper; gastight crimped; acc. to DIN 46228, Part 4/09.90; red     | <a href="http://www.wago.com/216-243">www.wago.com/216-243</a> |
|  | <b>Item no.: 216-244</b><br>Ferrule; Sleeve for 1.5 mm <sup>2</sup> / AWG 16; insulated; electro-tin plated; electrolytic copper; gastight crimped; acc. to DIN 46228, Part 4/09.90; black | <a href="http://www.wago.com/216-244">www.wago.com/216-244</a> |
|  | <b>Item no.: 216-262</b><br>Ferrule; Sleeve for 0.75 mm <sup>2</sup> / 18 AWG; insulated; electro-tin plated; electrolytic copper; gastight crimped; acc. to DIN 46228, Part 4/09.90; gray | <a href="http://www.wago.com/216-262">www.wago.com/216-262</a> |
|  | <b>Item no.: 216-263</b><br>Ferrule; Sleeve for 1 mm <sup>2</sup> / AWG 18; insulated; electro-tin plated; electrolytic copper; gastight crimped; acc. to DIN 46228, Part 4/09.90; red     | <a href="http://www.wago.com/216-263">www.wago.com/216-263</a> |
|  | <b>Item no.: 216-264</b><br>Ferrule; Sleeve for 1.5 mm <sup>2</sup> / AWG 16; insulated; electro-tin plated; electrolytic copper; gastight crimped; acc. to DIN 46228, Part 4/09.90; black | <a href="http://www.wago.com/216-264">www.wago.com/216-264</a> |

Subject to changes. Please also observe the further product documentation!

|  |  |  |
|--|--|--|
|  | <p><b>Item no.: 216-284</b><br/>                 Ferrule; Sleeve for 1.5 mm<sup>2</sup> / AWG 16; insulated; electro-tin plated; electrolytic copper; gastight crimped; acc. to DIN 46228, Part 4/09.90; black</p> | <a href="http://www.wago.com/216-284">www.wago.com/216-284</a> |
|  | <p><b>Item no.: 216-301</b><br/>                 Ferrule; Sleeve for 0.25 mm<sup>2</sup> / AWG 24; insulated; electro-tin plated; yellow</p>   | <a href="http://www.wago.com/216-301">www.wago.com/216-301</a> |
|  | <p><b>Item no.: 216-302</b><br/>                 Ferrule; Sleeve for 0.34 mm<sup>2</sup> / 22 AWG; insulated; electro-tin plated; green</p>  | <a href="http://www.wago.com/216-302">www.wago.com/216-302</a> |
|  | <p><b>Item no.: 216-321</b><br/>                 Ferrule; Sleeve for 0.25 mm<sup>2</sup> / AWG 24; insulated; electro-tin plated; yellow</p>   | <a href="http://www.wago.com/216-321">www.wago.com/216-321</a> |
|  | <p><b>Item no.: 216-322</b><br/>                 Ferrule; Sleeve for 0.34 mm<sup>2</sup> / 22 AWG; insulated; electro-tin plated; green</p>  | <a href="http://www.wago.com/216-322">www.wago.com/216-322</a> |

## Downloads

### Documentation

#### Additional Information

|                        |             |               |          |
|------------------------|-------------|---------------|----------|
| Technical explanations | Apr 3, 2019 | pdf<br>3.6 MB | Download |
|------------------------|-------------|---------------|----------|

## CAD/CAE-Data

### CAD data

|                      |     |          |
|----------------------|-----|----------|
| 2D/3D Models 236-208 | URL | Download |
|----------------------|-----|----------|

### CAE data

|                           |     |          |
|---------------------------|-----|----------|
| EPLAN Data Portal 236-208 | URL | Download |
|---------------------------|-----|----------|

### PCB Design

|                              |     |          |
|------------------------------|-----|----------|
| Symbol and Footprint 236-208 | URL | Download |
|------------------------------|-----|----------|

CAX data for your PCB design, consisting of "schematic symbols and PCB footprints", allow easy integration of the WAGO component into your development environment.

### Supported formats:

- Accel EDA 14 & 15
- Altium 6 to current version
- Cadence Allegro
- DesignSpark
- Eagle Libraries

Subject to changes. Please also observe the further product documentation!



- KiCad
- Mentor Graphics BoardStation
- Mentor Graphics Design Architect
- Mentor Graphics Design Expedition 99 and 2000
- OrCAD 9.X PCB and Capture
- PADS PowerPCB 3, 3.5, 4.X, and 5.X
- PADS PowerPCB and PowerLogic 3.0
- PCAD 2000, 2001, 2002, 2004, and 2006
- Pulsonix 8.5 or newer
- STL
- 3D STEP
- TARGET 3001!
- View Logic ViewDraw
- Quadcept
- Zuken CadStar 3 and 4
- Zuken CR-5000 and CR-8000

PCB Component Libraries (EDA), PCB CAD Library Ultra Librarian

---

## Installation Notes

### Inserting a conductor

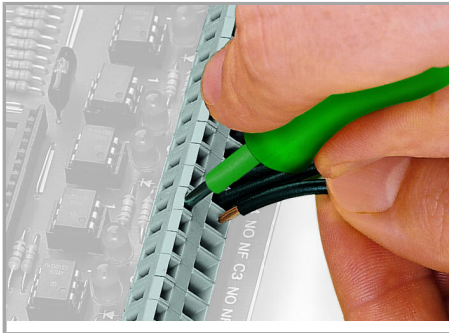

Inserting a conductor via 3.5 mm screwdriver.

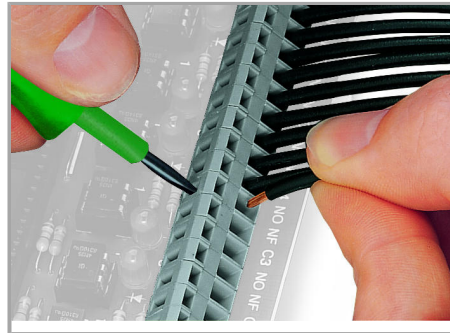

Inserting a conductor via 3.5 mm screwdriver.

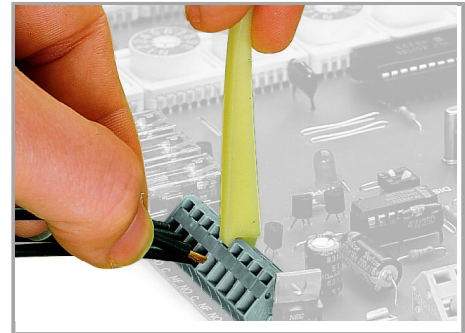

Inserting a conductor via operating tool.

Screwdriver actuation parallel to conductor entry.

Screwdriver actuation perpendicular to conductor entry.

Subject to changes. Please also observe the further product documentation!



Compared to standard screwdrivers, these operating tools are far more convenient for wiring PCB terminal strips at factory.

#### Assembly

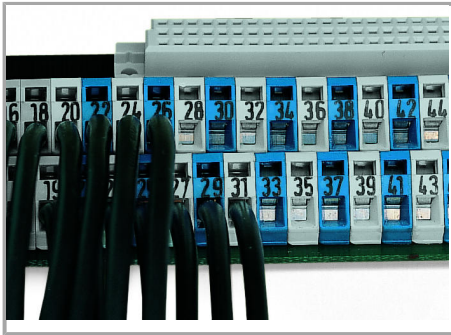

PCB Terminal Strips placed behind each other save space – staggering them by half the pin spacing simplifies subsequent wiring of the first row.

#### Assembly

Subject to changes. Please also observe the further product documentation!



Combining PCB terminal blocks with different pin spacing.

### Marking



Labeling via factory direct marking.



Labeling with self-adhesive marking strips.

Subject to changes. Please also observe the further product documentation!