

Data sheet | Item number: 234-208

PCB terminal block; push-button; 0.5 mm²; Pin spacing 2.5 mm; 8-pole;
CAGE CLAMP®; 0,50 mm²; gray

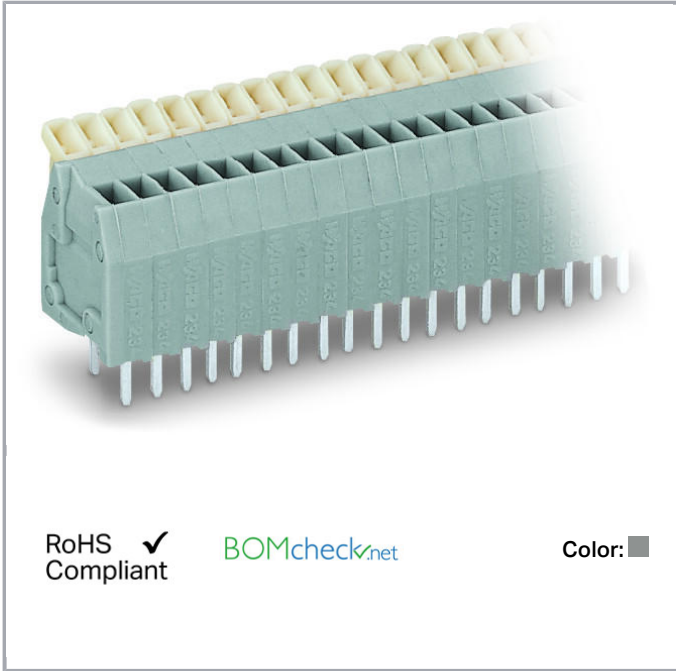

www.wago.com/234-208



RoHS Compliant

BOMcheck.net

Color: ■

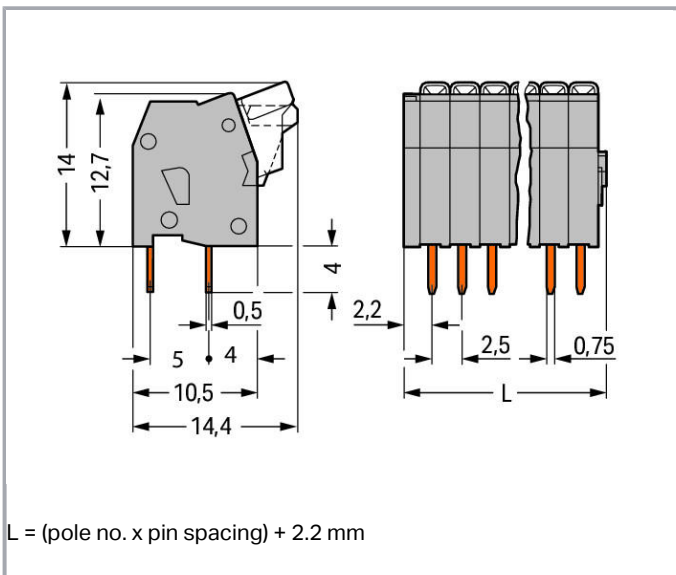
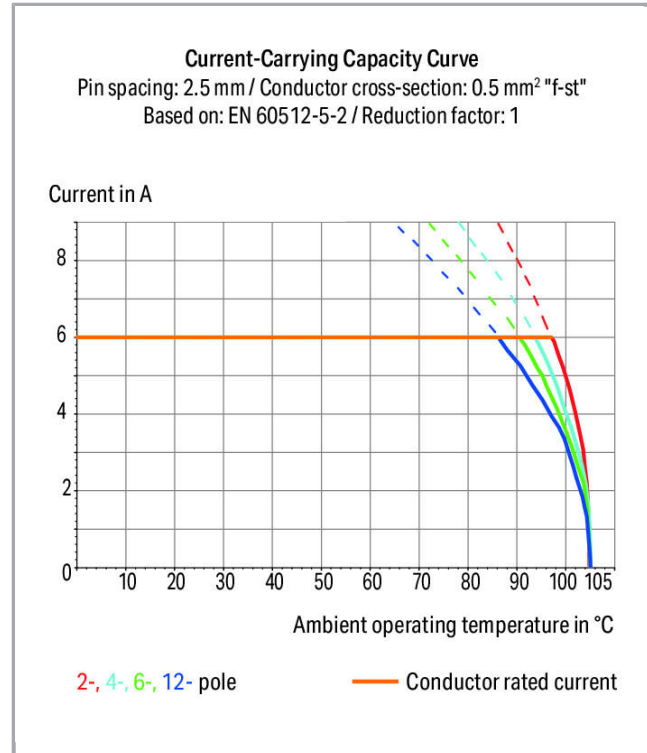

Subject to changes. Please also observe the further product documentation!

WAGO Kontakttechnik GmbH & Co. KG
Hansastr. 27
32423 Minden
Phone: +49571 887-0 | Fax: +49571 887-169
Email: info.de@wago.com | Web: www.wago.com

Do you have any questions about our products?
We are always happy to take your call at +49 (571) 887-44222.

Item description

- PCB terminal strips with push-buttons and CAGE CLAMP® connection
- Double solder pins for high mechanical stability on PCB
- Ideal for in-the-field wiring thanks to simplified push-button actuation
- Convenient, tool-free operation

Data

Electrical data

Ratings per IEC/EN 60664-1

Ratings per	IEC/EN 60664-1
Rated voltage (III / 3)	63 V
Rated impulse voltage (III / 3)	2.5 kV
Rated voltage (III / 2)	160 V
Rated impulse voltage (III / 2)	2.5 kV
Rated voltage (II / 2)	320 V
Rated impulse voltage (II / 2)	2.5 kV
Rated current	6 A
Legend (ratings)	(III / 2) ≙ Overvoltage category III / Pollution degree 2

Approvals per UL 1059

Rated voltage UL (Use Group B)	150 V
Rated current UL (Use Group B)	4 A
Approvals per	UL 1059

Approvals per CSA

Rated voltage CSA (Use Group B)	150 V
Rated current CSA (Use Group B)	4 A

Connection data

Connection technology	CAGE CLAMP®
Actuation type	Push-button
Solid conductor	0,08 ... 0,5 mm ² / 28 ... 20 AWG
Fine-stranded conductor	0,08 ... 0,5 mm ² / 28 ... 20 AWG

Subject to changes. Please also observe the further product documentation!



Fine-stranded conductor with ferrule with plastic collar	0,25 mm ²
Fine-stranded conductor with ferrule without plastic collar	0,25 mm ²
Strip length	5 ... 6 mm / 0.2 ... 0.24 inch
Conductor entry angle to the PCB	90°
No. of poles	8
Total number of connection points	8
Total number of potentials	8
Number of connection types	1
Number of levels	1

Geometrical Data

Pin spacing	2,5 mm / 0.098 inch
Width	22,2 mm / 0.874 inch
Height	18 mm / 0.709 inch
Height from the surface	14 mm / 0.551 inch
Depth	14,4 mm / 0.567 inch
Solder pin length	4 mm
Solder pin dimensions	0,5 x 0,75 mm
Drilled hole diameter (tolerance)	1,1 (+0,1) mm

PCB contact

PCB contact	THT
Solder pin arrangement	over the entire terminal strip (in-line)
Number of solder pins per potential	2

Material Data

Color	gray
Material group	I
Insulating material	Polyamide 66 (PA 66)
Flammability class per UL94	V0
Clamping spring material	Chrome nickel spring steel (CrNi)
Contact material	Electrolytic copper (E _{Cu})
Contact plating	tin-plated
Fire load	0.06 MJ
Weight	4.1 g

Subject to changes. Please also observe the further product documentation!

Environmental Requirements





Limit temperature range -60 ... +105 °C

Commercial data

Product Group	4 (Printed Circuit)
Packaging type	BOX
Country of origin	CH
GTIN	4044918651547
Customs Tariff No.	85369010000

Approvals / Certificates

Country specific Approvals

Logo	Approval	Additional Approval Text	Certificate name
	CCA DEKRA Certification B.V.	EN 60998	NTR NL 6946
	CCA DEKRA Certification B.V.	EN 60998	2153951.01
	CCA DEKRA Certification B.V.	EN 60947	2169331.03
	CCA DEKRA Certification B.V.	EN 60947-7-4	NTR NL- 7270
	CSA DEKRA Certification B.V.	C22.2	1465035

UL-Approvals

Logo	Approval	Additional Approval Text	Certificate name
	UL UL International Germany GmbH	UL 1059	20190731- E45172



Subject to changes. Please also observe the further product documentation!



Counterpart

Compatible products

ferrule

	Item no.: 216-131 Ferrule; Sleeve for 0.25 mm ² / AWG 24; uninsulated; electro-tin plated	www.wago.com/216-131
	Item no.: 216-151 Ferrule; Sleeve for 0.25 mm ² / AWG 24; uninsulated; electro-tin plated	www.wago.com/216-151
	Item no.: 216-301 Ferrule; Sleeve for 0.25 mm ² / AWG 24; insulated; electro-tin plated; yellow	www.wago.com/216-301
	Item no.: 216-321 Ferrule; Sleeve for 0.25 mm ² / AWG 24; insulated; electro-tin plated; yellow	www.wago.com/216-321

Marking accessories

	Item no.: 210-331/250-202 Marking strips; as a DIN A4 sheet; MARKED; 1-16 (400x); Height of marker strip: 2.3 mm/0.091 in; Strip length 182 mm; Horizontal marking; Self-adhesive; white	www.wago.com/210-331/250-202
	Item no.: 210-331/250-204 Marking strips; as a DIN A4 sheet; MARKED; 17-32 (400x); Height of marker strip: 2.3 mm/0.091 in; Strip length 182 mm; Horizontal marking; Self-adhesive; white	www.wago.com/210-331/250-204
	Item no.: 210-331/250-206 Marking strips; as a DIN A4 sheet; MARKED; 33-48 (400x); Height of marker strip: 2.3 mm/0.091 in; Strip length 182 mm; Horizontal marking; Self-adhesive; white	www.wago.com/210-331/250-206
	Item no.: 210-331/250-207 Marking strips; as a DIN A4 sheet; MARKED; 1-48 (100x); Height of marker strip: 2.3 mm/0.091 in; Strip length 182 mm; Horizontal marking; Self-adhesive; white	www.wago.com/210-331/250-207

tools

	Item no.: 210-648 Operating tool; Blade: 2.5 x 0.4 mm; with a partially insulated shaft; angled; short	www.wago.com/210-648
	Item no.: 210-719 Operating tool; Blade: 2.5 x 0.4 mm; with a partially insulated shaft	www.wago.com/210-719

Subject to changes. Please also observe the further product documentation!



Downloads

Documentation

Additional Information

Technical explanations	Apr 3, 2019	pdf 3.6 MB	Download
------------------------	-------------	---------------	----------

CAD/CAE-Data

CAD data

2D/3D Models 234-208	URL	Download
----------------------	-----	----------

CAE data

EPLAN Data Portal 234-208	URL	Download
---------------------------	-----	----------

PCB Design

Symbol and Footprint 234-208	URL	Download
------------------------------	-----	----------

CAX data for your PCB design, consisting of "schematic symbols and PCB footprints", allow easy integration of the WAGO component into your development environment.

Supported formats:

- Accel EDA 14 & 15
- Altium 6 to current version
- Cadence Allegro
- DesignSpark
- Eagle Libraries
- KiCad
- Mentor Graphics BoardStation
- Mentor Graphics Design Architect
- Mentor Graphics Design Expedition 99 and 2000
- OrCAD 9.X PCB and Capture
- PADS PowerPCB 3, 3.5, 4.X, and 5.X
- PADS PowerPCB and PowerLogic 3.0
- PCAD 2000, 2001, 2002, 2004, and 2006
- Pulsonix 8.5 or newer
- STL
- 3D STEP

Subject to changes. Please also observe the further product documentation!

- TARGET 3001!
- View Logic ViewDraw
- Quadcept
- Zuken CadStar 3 and 4
- Zuken CR-5000 and CR-8000

PCB Component Libraries (EDA), PCB CAD Library Ultra Librarian

Installation Notes

Conductor termination

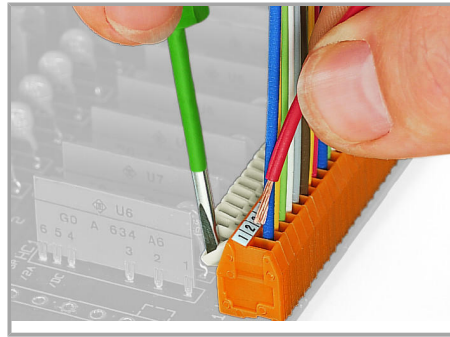

Nominal cross-section: 0.5 mm² (20 AWG);

Inserting/removing a conductor.

0.75 mm² (18 AWG) only in every other position

Marking



Labeling via self-adhesive marking strips or factory direct marking.

Subject to changes. Please also observe the further product documentation!