

Data sheet | Item number: 231-126

Testing plug module with contact stud; for 280, 736, 737, 738, 780 Series;
Pin spacing 5 mm / 0.197 in; 2,50 mm²; gray

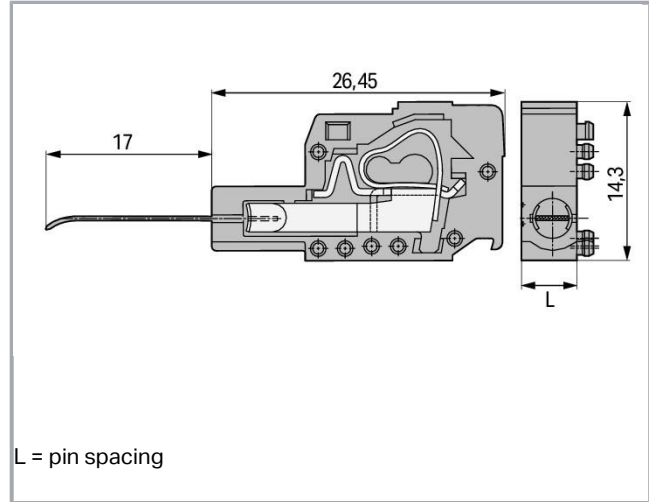

www.wago.com/231-126

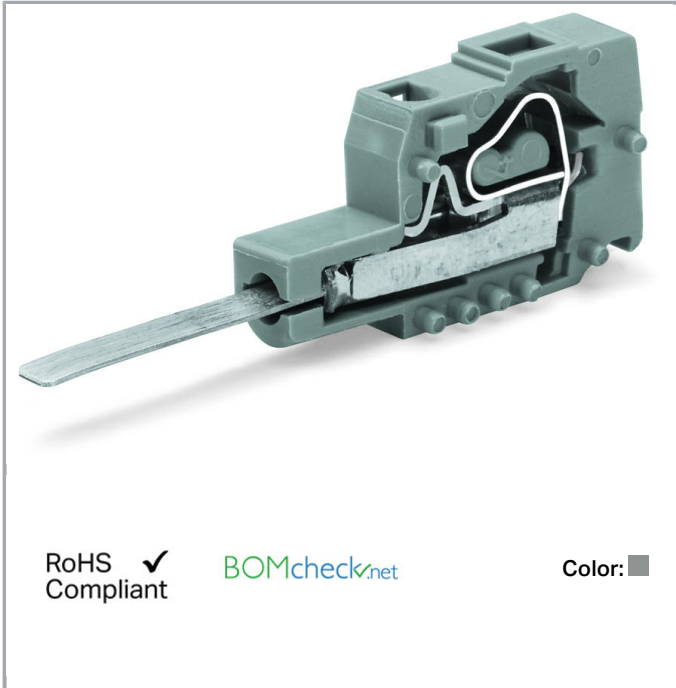

Data

Electrical data

Ratings per IEC/EN 60664-1

Ratings per	IEC/EN 60664-1
Rated voltage (III / 2)	250 V
Rated impulse voltage (III / 2)	2.5 kV
Rated current	0.5 A
Legend (ratings)	(III / 2) ≙ Overvoltage category III / Pollution degree 2

Approvals per UL 1059

Approvals per	UL 1059
---------------	---------

Connection data

Connection technology	CAGE CLAMP®
-----------------------	-------------

Subject to changes. Please also observe the further product documentation!

WAGO Kontakttechnik GmbH & Co. KG
Hansastr. 27
32423 Minden
Phone: +49571 887-0 | Fax: +49571 887-169
Email: info.de@wago.com | Web: www.wago.com

Do you have any questions about our products?
We are always happy to take your call at +49 (571) 887-44222.



Solid conductor	0,08 ... 2,5 mm ² / 28 ... 12 AWG
Fine-stranded conductor	0,08 ... 2,5 mm ² / 28 ... 12 AWG
Strip length	12 ... 13 mm / 0.47 ... 0.51 inch
Total number of connection points	1
Total number of potentials	1
Number of connection types	1

Geometrical Data

Pin spacing	5 mm / 0.197 inch
Width	5 mm / 0.197 inch
Height	14,3 mm / 0.563 inch
Depth	43,45 mm / 1.711 inch

Mechanical data

Test contact length	17 mm
Application	Testing without connected conductor
Suitable	for 280, 736, 737, 738, 780 Series

Material Data

Color	gray
Material group	I
Insulating material	Polyamide 66 (PA 66)
Flammability class per UL94	V0
Clamping spring material	Chrome nickel spring steel (CrNi)
Contact material	Electrolytic copper (E _{Cu})
Contact plating	tin-plated
Fire load	0.024 MJ
Weight	2.1 g

Environmental Requirements

Limit temperature range	-60 ... +105 °C
-------------------------	-----------------

Commercial data

Product Group	3 (Multi Conn. System)
Packaging type	BOX
Country of origin	DE

Subject to changes. Please also observe the further product documentation!

GTIN	4045454193584
Customs Tariff No.	85366990990

Approvals / Certificates

Country specific Approvals

Logo	Approval	Additional Approval Text	Certificate name
	CSA DEKRA Certification B.V.	C22.2	1466354



Ship Approvals

Logo	Approval	Additional Approval Text	Certificate name
	LR Lloyds Register	IEC 61984	96/20035 (E5)

Counterpart

Compatible products

tools

	Item no.: 210-657 Operating tool; Blade: 3.5 x 0.5 mm; with a partially insulated shaft; short	www.wago.com/210-657
	Item no.: 210-720 Operating tool; Blade: 3.5 x 0.5 mm; with a partially insulated shaft	www.wago.com/210-720

End plate

Item no.: 231-100 End plate; 1.5 mm thick; gray	www.wago.com/231-100
---	--

Downloads

Documentation

Additional Information

Technical explanations	Apr 3, 2019	pdf 3.6 MB	Download
------------------------	-------------	---------------	----------

Subject to changes. Please also observe the further product documentation!

Installation Notes

Assembly

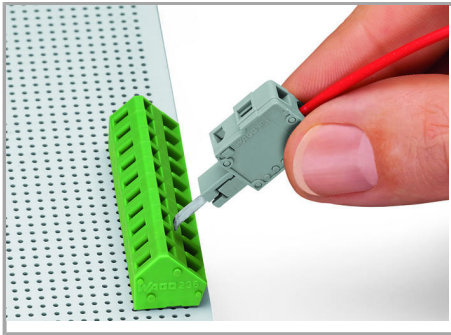

Inserting a test plug module into the operating slot.

Testing

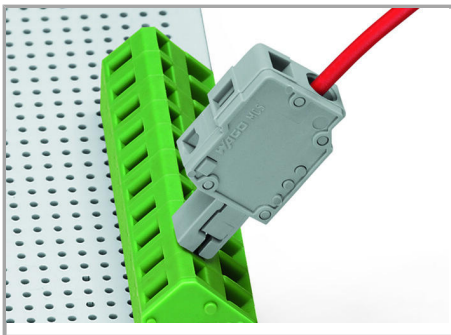

Unwired terminal strip with inserted test plug module

Application

Subject to changes. Please also observe the further product documentation!

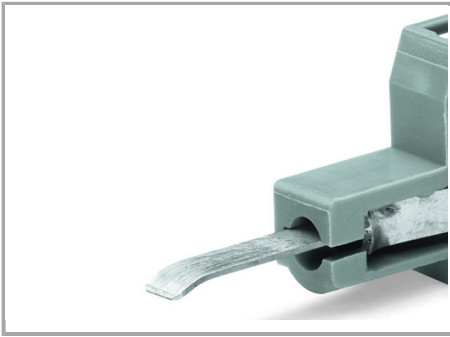

Contact type A:

Testing only when unwired.

Subject to changes. Please also observe the further product documentation!