

Data sheet | Item number: 221-500/000-006

Mounting carrier; 221 Series - 4 mm²; for DIN-35 rail mounting/screw mounting; blue

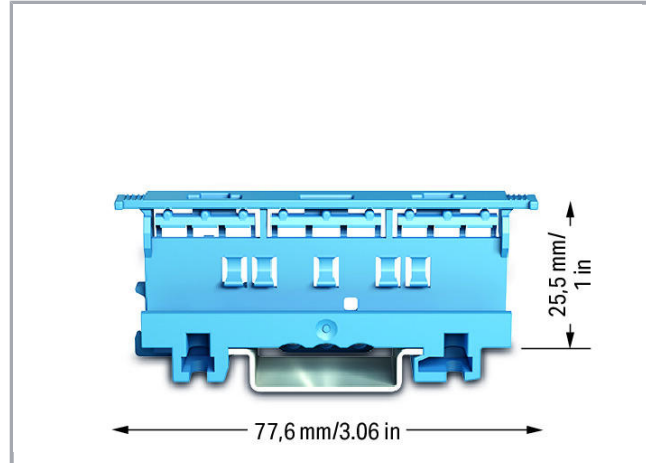

www.wago.com/221-500/000-006

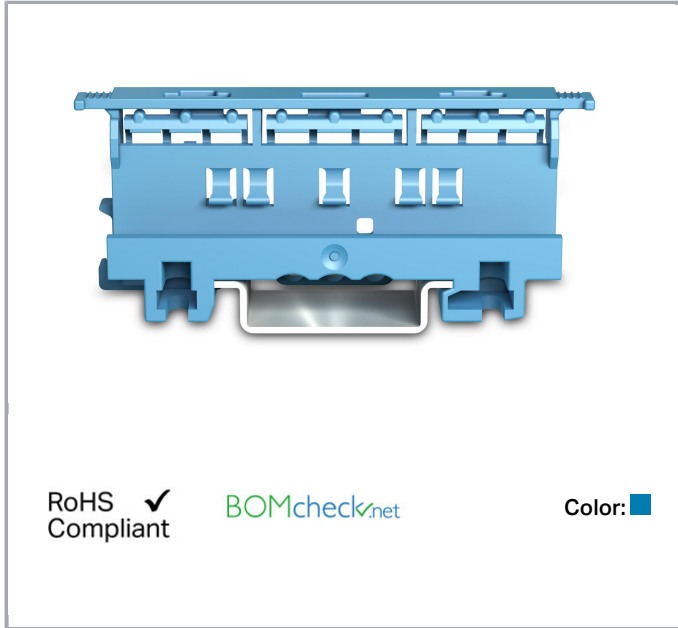

Data

Geometrical Data

Width	17,5 mm / 0.689 inch
Height from upper-edge of DIN-35 rail	25,5 mm / 1.004 inch
Depth	77,6 mm / 3.055 inch

Material Data

Color	blue
Insulating material	Polyamide 66 (PA 66)
Flammability class per UL94	V0
Weight	9.6 g

Commercial data

Packaging type	BOX
Country of origin	CN
GTIN	4055143833547
Customs Tariff No.	39269097900

Subject to changes. Please also observe the further product documentation!

WAGO Kontakttechnik GmbH & Co. KG
Hansastr. 27
32423 Minden
Phone: +49571 887-0 | Fax: +49571 887-169
Email: info.de@wago.com | Web: www.wago.com

Do you have any questions about our products?
We are always happy to take your call at +49 (571) 887-44222.

Counterpart

Compatible products

Marking accessories

Item no.: 210-833

Marking strips; on reel; 6 mm wide; plain; Self-adhesive; white

www.wago.com/210-833

Mounting adapter



Item no.: 222-505

Strain relief plate; for mounting carrier; 221 or 222 Series, can be snapped

www.wago.com/222-505



Item no.: 222-510

Angled DIN-rail adapter; in combination with mounting carrier; 221-500 or 222-500; for DIN-35 rail mounting; gray

www.wago.com/222-510

Downloads

Documentation

Additional Information

Technical explanations

Apr 3, 2019

pdf
2.1 MB

[Download](#)

Installation Notes

Inserting a conductor

Subject to changes. Please also observe the further product documentation!

WAGO Kontakttechnik GmbH & Co. KG

Hansastr. 27

32423 Minden

Phone: +49571 887-0 | Fax: +49571 887-169

Email: info.de@wago.com | Web: www.wago.com

Do you have any questions about our products?

We are always happy to take your call at +49 (571) 887-44222.

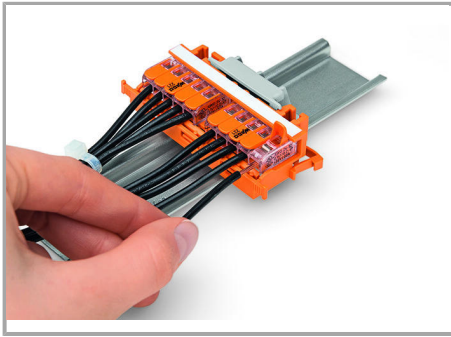

CAGE CLAMP® connection:

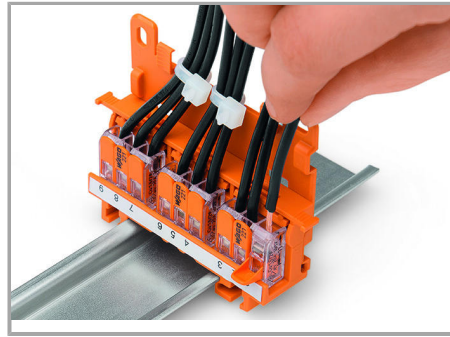

Removing a conductor.

Conductor termination with connectors fitted in a mounting carrier

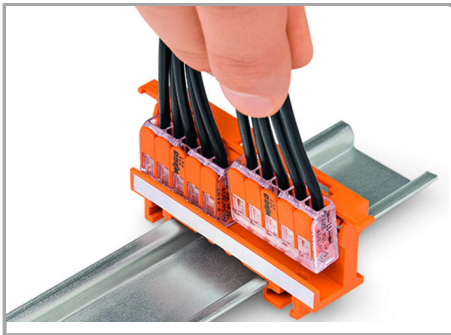

Inserting a connector into the mounting carrier.

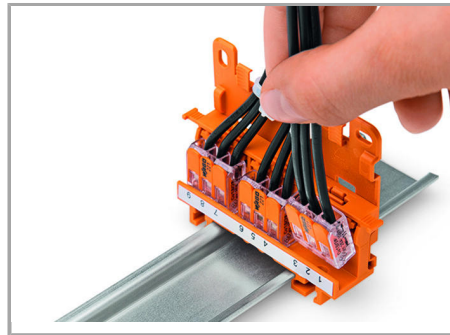

Inserting a connector into the mounting carrier.

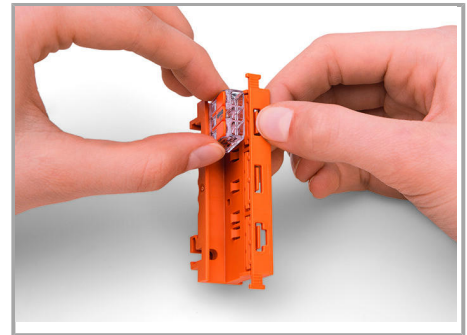

Removing a connector from the mounting carrier.

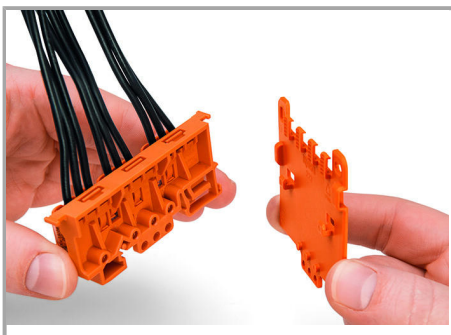

Securing a strain relief plate (222-505) to the mounting carrier.

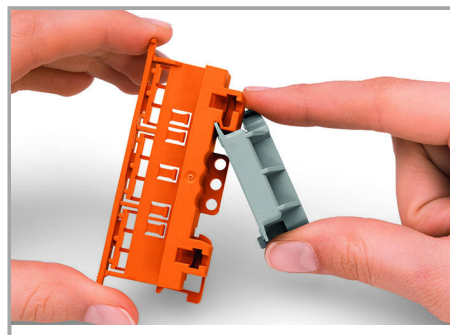

Snapping the angled DIN-rail adapter (222-510) onto the mounting carrier.

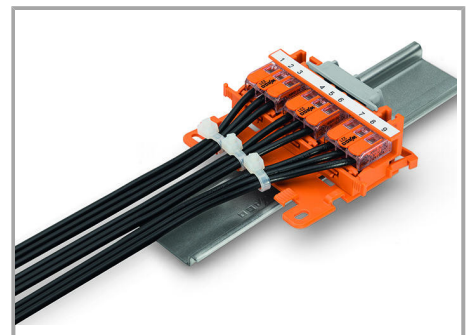

Horizontal mounting on DIN-35 rail using an angled DIN-rail adapter.

Subject to changes. Please also observe the further product documentation!

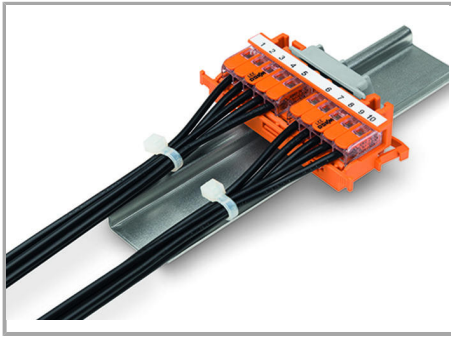

Horizontal mounting on DIN-35 rail using an angled DIN-rail adapter.

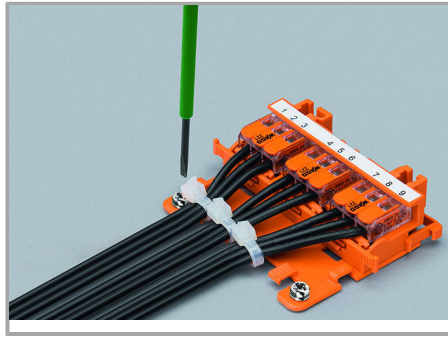

Horizontal screw mounting with strain relief plate on a flat surface



Vertical mounting with strain relief plate on DIN-35 rail.

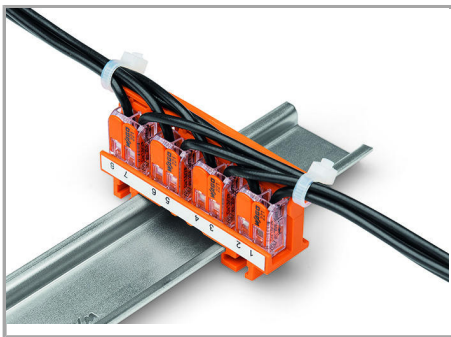

Strain relief via cable ties on the mounting carrier (transverse to the connectors' wiring direction) – clamping units labeled via marking strips (210-334).

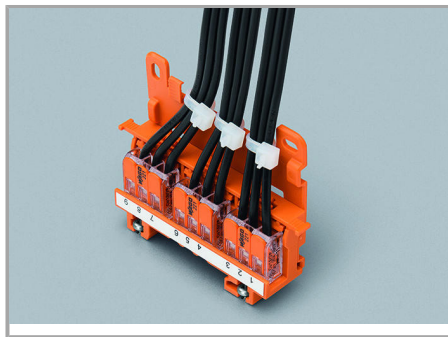

Vertical screw mounting with strain relief plate on a flat surface.

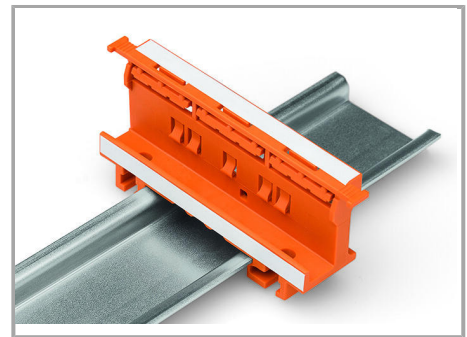

Mounting carrier on a DIN-35 rail

Testing

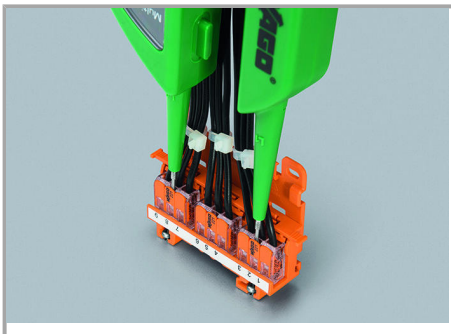

Testing connectors via test slots on top of the carrier.

Ex Application

Subject to changes. Please also observe the further product documentation!

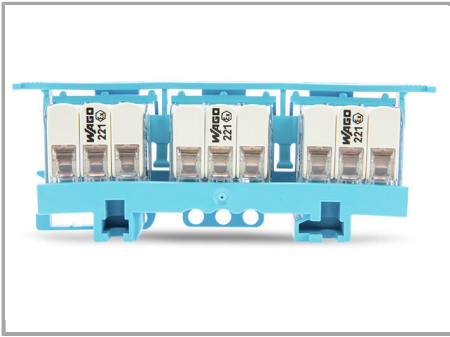

Carriers with a blue insulated housing are suitable for Ex i applications. Both clearances and creepage distances for the protection type "intrinsic safety Ex i" must be observed.

Subject to changes. Please also observe the further product documentation!