

Data sheet | Item number: 2210-1301

3-conductor through terminal block; with push-button; 10 mm²; with test port; side and center marking; for DIN-rail 35 x 15 and 35 x 7.5; Push-in CAGE CLAMP®; 10,00 mm²; gray

www.wago.com/2210-1301

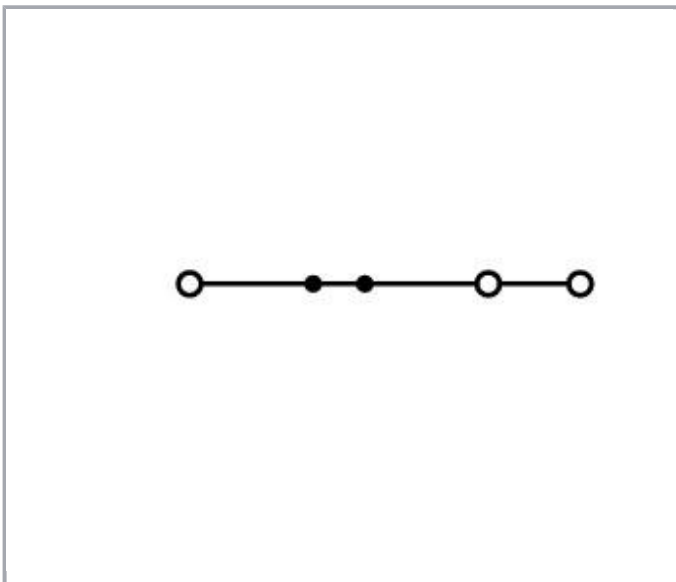
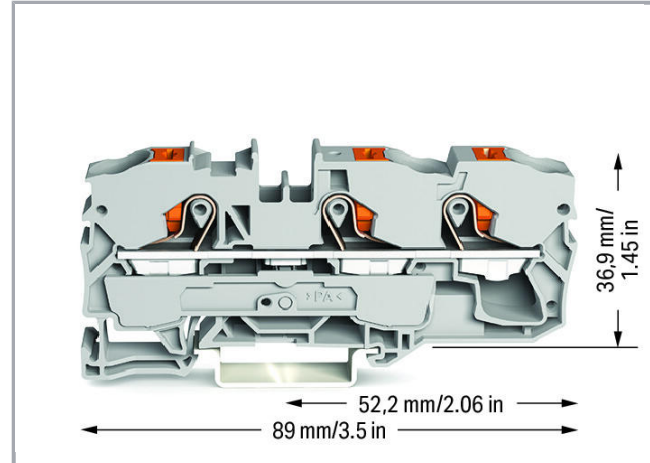
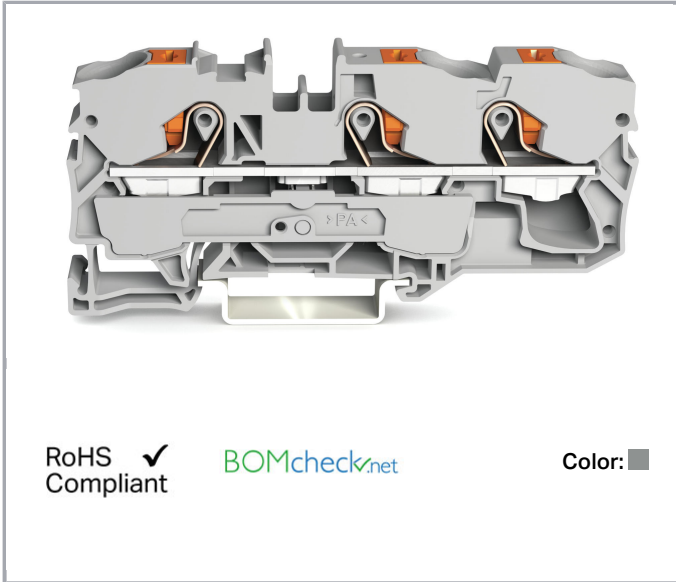

Data

Electrical data

Subject to changes. Please also observe the further product documentation!

WAGO Kontakttechnik GmbH & Co. KG
Hansastr. 27
32423 Minden
Phone: +49571 887-0 | Fax: +49571 887-169
Email: info.de@wago.com | Web: www.wago.com

Do you have any questions about our products?
We are always happy to take your call at +49 (571) 887-44222.



Ratings per IEC/EN 60664-1

Ratings per	IEC/EN 60947-7-1
Rated voltage (III / 3)	800 V
Rated impulse voltage (III / 3)	8 kV
Rated current	57 A
Rated current (2)	76 A
Legend (ratings)	(III / 3) $\hat{=}$ Overvoltage category III / Pollution degree 3

Connection data

Connection technology	Push-in CAGE CLAMP®
Actuation type	Push-in Push-button
Connectable conductor materials	Copper
Nominal cross section	10 mm ²
Solid conductor	0,5 ... 16 mm ² / 20 ... 6 AWG
Solid conductor, push-in termination	2,5 ... 16 mm ² / 14 ... 6 AWG
Fine-stranded conductor	0,5 ... 16 mm ² / 20 ... 6 AWG
Fine-stranded conductor with ferrule with plastic collar	4 ... 10 mm ² / 12 ... 8 AWG
Fine-stranded conductor with ferrule, push-in termination, from	4 ... 10 mm ² / 12 ... 8 AWG
Strip length	17 ... 19 mm / 0.67 ... 0.75 inch
Total number of connection points	3
Total number of potentials	1
Number of levels	1
Type of wiring	Front-entry wiring
Note (conductor cross-section)	Depending on the conductor characteristic, a conductor with a smaller cross-section can also be inserted via push-in termination.
Number of jumper slots	2

Geometrical Data

Width	10 mm / 0.394 inch
Height from upper-edge of DIN-35 rail	36,9 mm / 1.453 inch
Depth	89 mm / 3.504 inch

Mechanical data

Design	horizontal type
--------	-----------------

Subject to changes. Please also observe the further product documentation!

WAGO Kontakttechnik GmbH & Co. KG
 Hansastr. 27
 32423 Minden
 Phone: +49571 887-0 | Fax: +49571 887-169
 Email: info.de@wago.com | Web: www.wago.com

Do you have any questions about our products?
 We are always happy to take your call at +49 (571) 887-44222.

Type of mounting	DIN-35 rail
Marking level	Center/side marking

Material Data



Color	gray
Insulating material	Polyamide 66 (PA 66)
Weight	25.5 g

Commercial data

Packaging type	BOX
Country of origin	DE
GTIN	4055143736114
Customs Tariff No.	85369010000

Approvals / Certificates

Ex-Approvals

Logo	Approval	Additional Approval Text	Certificate name
	ATEX Physikalisch Technische Bundesanstalt	IEC 60079-0	PTB 18 ATEX 1008 U (II 2 G Ex eb IIC Gb)
	ATEX UL International Demko A/S	UL 60079	E185892
	IECEX Physikalisch Technische Bundesanstalt	IEC 60079	IECEX PTB 18.0015U (Ex eb IIC Gb and Ex eb I Mb)

Country specific Approvals

Logo	Approval	Additional Approval Text	Certificate name
	CCA DEKRA Certification B.V.	EN 60947	NTR NL 7668
	CSA	C22.2	70175033

Subject to changes. Please also observe the further product documentation!



DEKRA Certification B.V.



KEMA/KEUR



DEKRA Certification B.V.

EN 60947

71-

108310

Ship Approvals

Logo	Approval	Additional Approval Text	Certificate name
	ABS American Bureau of Shipping	-	19- HG1866350- PDA
	DNV GL Det Norske Veritas, Germanischer Lloyd	-	TAE00003JT
	LR Lloyds Register	-	19/20050

UL-Approvals

Logo	Approval	Additional Approval Text	Certificate name
	UL Underwriters Laboratories Inc.	UL 1059	4788362280

Counterpart





Compatible products

Subject to changes. Please also observe the further product documentation!

WAGO Kontakttechnik GmbH & Co. KG
 Hansastr. 27
 32423 Minden
 Phone: +49571 887-0 | Fax: +49571 887-169
 Email: info.de@wago.com | Web: www.wago.com

Do you have any questions about our products?
 We are always happy to take your call at +49 (571) 887-44222.



ferrule

	Item no.: 216-284 Ferrule; Sleeve for 1.5 mm ² / AWG 16; insulated; electro-tin plated; electrolytic copper; gastight crimped; acc. to DIN 46228, Part 4/09.90; black	www.wago.com/216-284
	Item no.: 216-286 Ferrule; Sleeve for 2.5 mm ² / AWG 14; insulated; electro-tin plated; electrolytic copper; gastight crimped; acc. to DIN 46228, Part 4/09.90; blue	www.wago.com/216-286
	Item no.: 216-287 Ferrule; Sleeve for 4 mm ² / AWG 12; insulated; electro-tin plated; electrolytic copper; gastight crimped; acc. to DIN 46228, Part 4/09.90; gray	www.wago.com/216-287
	Item no.: 216-288 Ferrule; Sleeve for 6 mm ² / AWG 10; insulated; electro-tin plated; electrolytic copper; gastight crimped; acc. to DIN 46228, Part 4/09.90; yellow	www.wago.com/216-288
	Item no.: 216-289 Ferrule; Sleeve for 10 mm ² / AWG 8; insulated; electro-tin plated; electrolytic copper; gastight crimped; acc. to DIN 46228, Part 4/09.90; red	www.wago.com/216-289









General accessories

	Item no.: 2010-100 Finger guard; touchproof cover protects unused conductor entries; yellow	www.wago.com/2010-100
--	---	--









Marking accessories

	Item no.: 2009-110 Marking strips; on reel; not stretchable; plain; snap-on type; white	www.wago.com/2009-110
	Item no.: 2009-115 WMB-Inline; for Smart Printer; 1500 pieces on roll; stretchable 5 - 5.2 mm; plain; snap-on type; white	www.wago.com/2009-115
	Item no.: 2009-115/000-002 WMB-Inline; for Smart Printer; 1500 pieces on roll; stretchable 5 - 5.2 mm; plain; snap-on type; yellow	www.wago.com/2009-115/000-002
	Item no.: 2009-115/000-006 WMB-Inline; for Smart Printer; 1500 pieces on roll; stretchable 5 - 5.2 mm; plain; snap-on type; white	www.wago.com/2009-115/000-006
	Item no.: 2009-115/000-007 WMB-Inline; for Smart Printer; 1500 pieces on roll; stretchable 5 - 5.2 mm; plain; snap-on type; gray	www.wago.com/2009-115/000-007
	Item no.: 2009-115/000-012 WMB-Inline; for Smart Printer; 1500 pieces on roll; stretchable 5 - 5.2 mm; plain; snap-on type; white	www.wago.com/2009-115/000-012
	Item no.: 2009-115/000-017 WMB-Inline; for Smart Printer; 1500 pieces on roll; stretchable 5 - 5.2 mm; plain; snap-on type; white	www.wago.com/2009-115/000-017

Subject to changes. Please also observe the further product documentation!

	Item no.: 2009-115/000-023 WMB-Inline; for Smart Printer; 1500 pieces on roll; stretchable 5 - 5.2 mm; plain; snap-on type; green	www.wago.com/2009-115/000-023
	Item no.: 2009-115/000-024 WMB-Inline; for Smart Printer; 1500 pieces on roll; stretchable 5 - 5.2 mm; plain; snap-on type; white	www.wago.com/2009-115/000-024
	Item no.: 2009-145 Mini-WSB Inline; for Smart Printer; 1700 pieces on roll; stretchable 5 - 5.2 mm; plain; snap-on type; white	www.wago.com/2009-145
	Item no.: 2009-145/000-002 Mini-WSB Inline; for Smart Printer; 1700 pieces on roll; stretchable 5 - 5.2 mm; plain; snap-on type; white	www.wago.com/2009-145/000-002
	Item no.: 2009-145/000-005 Mini-WSB Inline; for Smart Printer; 1700 pieces on roll; stretchable 5 - 5.2 mm; plain; snap-on type; red	www.wago.com/2009-145/000-005
	Item no.: 2009-145/000-006 Mini-WSB Inline; for Smart Printer; 1700 pieces on roll; stretchable 5 - 5.2 mm; plain; snap-on type; blue	www.wago.com/2009-145/000-006
	Item no.: 2009-145/000-007 Mini-WSB Inline; for Smart Printer; 1700 pieces on roll; stretchable 5 - 5.2 mm; plain; snap-on type; white	www.wago.com/2009-145/000-007
	Item no.: 2009-145/000-012 Mini-WSB Inline; for Smart Printer; 1700 pieces on roll; stretchable 5 - 5.2 mm; plain; snap-on type; orange	www.wago.com/2009-145/000-012
	Item no.: 2009-145/000-023 Mini-WSB Inline; for Smart Printer; 1700 pieces on roll; stretchable 5 - 5.2 mm; plain; snap-on type; green	www.wago.com/2009-145/000-023
	Item no.: 2009-145/000-024 Mini-WSB Inline; for Smart Printer; 1700 pieces on roll; stretchable 5 - 5.2 mm; plain; snap-on type; violet	www.wago.com/2009-145/000-024
	Item no.: 2009-191 Group marker carrier	www.wago.com/2009-191
	Item no.: 2009-192 Group marker carrier	www.wago.com/2009-192
	Item no.: 2009-193 Group marker carrier	www.wago.com/2009-193
	Item no.: 2009-198 Adaptor	www.wago.com/2009-198
	Item no.: 248-501 Miniature WSB Quick marking system; plain; Marker width 5 mm; 10 strips with 10 markers per card	www.wago.com/248-501

Subject to changes. Please also observe the further product documentation!

	<p>Item no.: 248-501/000-002 Mini-WSB marking card; as card; not stretchable; plain; snap-on type; yellow</p>	<p>www.wago.com/248-501/000-002</p>
	<p>Item no.: 248-501/000-005 Mini-WSB marking card; as card; not stretchable; plain; snap-on type; red</p>	<p>www.wago.com/248-501/000-005</p>
	<p>Item no.: 248-501/000-006 Mini-WSB marking card; as card; not stretchable; plain; snap-on type; blue</p>	<p>www.wago.com/248-501/000-006</p>
	<p>Item no.: 248-501/000-007 Mini-WSB marking card; as card; not stretchable; plain; snap-on type; gray</p>	<p>www.wago.com/248-501/000-007</p>
	<p>Item no.: 248-501/000-012 Mini-WSB marking card; as card; not stretchable; plain; snap-on type; orange</p>	<p>www.wago.com/248-501/000-012</p>
	<p>Item no.: 248-501/000-017 Mini-WSB marking card; as card; not stretchable; plain; snap-on type; light green</p>	<p>www.wago.com/248-501/000-017</p>
	<p>Item no.: 248-501/000-023 Mini-WSB marking card; as card; not stretchable; plain; snap-on type; green</p>	<p>www.wago.com/248-501/000-023</p>
	<p>Item no.: 248-501/000-024 Mini-WSB marking card; as card; not stretchable; plain; snap-on type; violet</p>	<p>www.wago.com/248-501/000-024</p>
	<p>Item no.: 793-501 WMB marking card; as card; not stretchable; plain; snap-on type; white</p>	<p>www.wago.com/793-501</p>
	<p>Item no.: 793-501/000-002 WMB marking card; as card; not stretchable; plain; snap-on type; yellow</p>	<p>www.wago.com/793-501/000-002</p>
	<p>Item no.: 793-501/000-005 WMB marking card; as card; not stretchable; plain; snap-on type; red</p>	<p>www.wago.com/793-501/000-005</p>
	<p>Item no.: 793-501/000-006 WMB marking card; as card; not stretchable; plain; snap-on type; blue</p>	<p>www.wago.com/793-501/000-006</p>
	<p>Item no.: 793-501/000-007 WMB marking card; as card; not stretchable; plain; snap-on type; gray</p>	<p>www.wago.com/793-501/000-007</p>

Subject to changes. Please also observe the further product documentation!



Item no.: 793-501/000-012
WMB marking card; as card; not stretchable; plain; snap-on type; orange

www.wago.com/793-501/000-012



Item no.: 793-501/000-017
WMB marking card; as card; not stretchable; plain; snap-on type; light green

www.wago.com/793-501/000-017



Item no.: 793-501/000-023
WMB marking card; as card; not stretchable; plain; snap-on type; green

www.wago.com/793-501/000-023



Item no.: 793-501/000-024
WMB marking card; as card; not stretchable; plain; snap-on type; violet

www.wago.com/793-501/000-024



Item no.: 793-5501
WMB marking card; as card; for terminal block width 5 - 17.5 mm; stretchable 5 - 5.2 mm; plain; snap-on type; white

www.wago.com/793-5501

Item no.: 793-5501/000-002
WMB marking card; as card; for terminal block width 5 - 17.5 mm; stretchable 5 - 5.2 mm; plain; snap-on type; yellow

www.wago.com/793-5501/000-002

Item no.: 793-5501/000-005
WMB marking card; as card; for terminal block width 5 - 17.5 mm; stretchable 5 - 5.2 mm; plain; snap-on type; red

www.wago.com/793-5501/000-005



Item no.: 793-5501/000-006
WMB marking card; as card; for terminal block width 5 - 17.5 mm; stretchable 5 - 5.2 mm; plain; snap-on type; blue

www.wago.com/793-5501/000-006



Item no.: 793-5501/000-007
WMB marking card; as card; for terminal block width 5 - 17.5 mm; stretchable 5 - 5.2 mm; plain; snap-on type; gray

www.wago.com/793-5501/000-007

Item no.: 793-5501/000-012
WMB marking card; as card; for terminal block width 5 - 17.5 mm; stretchable 5 - 5.2 mm; plain; snap-on type; orange

www.wago.com/793-5501/000-012



Item no.: 793-5501/000-017
WMB marking card; as card; for terminal block width 5 - 17.5 mm; stretchable 5 - 5.2 mm; plain; snap-on type; green

www.wago.com/793-5501/000-017

Item no.: 793-5501/000-023
WMB marking card; as card; for terminal block width 5 - 17.5 mm; stretchable 5 - 5.2 mm; plain; snap-on type; light green

www.wago.com/793-5501/000-023



















Item no.: 793-5501/000-024
WMB marking card; as card; for terminal block width 5 - 17.5 mm; stretchable 5 - 5.2 mm; plain; snap-on type; violet

www.wago.com/793-5501/000-024

End plate

Subject to changes. Please also observe the further product documentation!

	Item no.: 2010-1391 End and intermediate plate; 1 mm thick; gray	www.wago.com/2010-1391
	Item no.: 2010-1392 End and intermediate plate; 1 mm thick; orange	www.wago.com/2010-1392
tools		
	Item no.: 210-721 Operating tool; Blade: 5.5 x 0.8 mm; with a partially insulated shaft	www.wago.com/210-721
Test Accessories		
	Item no.: 2009-174 Test plug adapter; for 4 mm Ø test plugs; for testing TOPJOB®S rail-mounted terminal blocks; gray	www.wago.com/2009-174
	Item no.: 2009-182 Testing tap; for max. 2.5 mm ² ; tool-free connection for individual test wires 0.08 - 2.5 mm; gray	www.wago.com/2009-182
	Item no.: 2010-511 Modular TOPJOB®S connector; modular; for jumper contact slot; 1-pole; 10,00 mm ² ; gray	www.wago.com/2010-511
	Item no.: 2010-549 Spacer module; modular; e.g., for bridging commoned terminal blocks; gray	www.wago.com/2010-549
Jumper		
	Item no.: 2010-402 Push-in type jumper bar; insulated; 2-way; Nominal current 57 A; light gray	www.wago.com/2010-402
	Item no.: 2010-403 Push-in type jumper bar; insulated; 3-way; Nominal current 57 A; light gray	www.wago.com/2010-403
	Item no.: 2010-404 Push-in type jumper bar; insulated; 4-way; Nominal current 57 A; light gray	www.wago.com/2010-404
	Item no.: 2010-405 Push-in type jumper bar; insulated; 5-way; Nominal current 57 A; light gray	www.wago.com/2010-405
	Item no.: 2010-405/011-000 Star point jumper; insulated; 3-way (1-3-5); IN = IN terminal block; light gray	www.wago.com/2010-405/011-000
	Item no.: 2010-433 Push-in type jumper bar; insulated; from 1 to 3; Nominal current 57 A; light gray	www.wago.com/2010-433
	Item no.: 2010-434 Push-in type jumper bar; insulated; from 1 to 4; Nominal current 57 A; light gray	www.wago.com/2010-434
	Item no.: 2010-435 Push-in type jumper bar; insulated; from 1 to 5; Nominal current 57 A; light gray	www.wago.com/2010-435
	Item no.: 2016-499 Step-down jumper; insulated; from 16/10 mm ² to 10/6/4/2.5 mm ² ; Nominal current 57 A; light gray	www.wago.com/2016-499

Subject to changes. Please also observe the further product documentation!



Item no.: 210-103

Wire commoning chain; insulated; 50 connections; black

www.wago.com/210-103

Item no.: 210-123

Wire commoning chain; insulated; 50 connections

www.wago.com/210-123



Item no.: 285-430

Step-down jumper; insulated; from 285-13x to 2010 and 2016 Series TOPJOB®S terminal blocks; Nominal current 90 A; gray

www.wago.com/285-430

Carrier rail

Item no.: 210-113

Steel carrier rail; 35 x 7.5 mm; 1 mm thick; 2 m long; unslotted; according to EN 60715

www.wago.com/210-113

Item no.: 210-114

Steel carrier rail; 35 x 15 mm; 1.5 mm thick; 2 m long; unslotted; similar to EN 60715

www.wago.com/210-114



Item no.: 210-118

Steel carrier rail; 35 x 15 mm; 2.3 mm thick; 2 m long; unslotted; according to EN 60715

www.wago.com/210-118

Item no.: 210-196

Aluminum carrier rail; 35 x 8.2 mm; 1.6 mm thick; 2 m long; unslotted; similar to EN 60715; silver-colored

www.wago.com/210-196



Item no.: 210-197

Steel carrier rail; 35 x 15 mm; 1.5 mm thick; 2 m long; slotted; similar to EN 60715

www.wago.com/210-197

Item no.: 210-198

Copper carrier rail; 35 x 15 mm; 2.3 mm thick; 2 m long; unslotted; according to EN 60715; copper-colored

www.wago.com/210-198

Downloads

Documentation

Additional Information

Technical explanations	Apr 3, 2019	pdf 2.1 MB	Download
------------------------	-------------	---------------	----------

CAD/CAE-Data

CAD data

2D/3D Models 2210-1301	URL	Download
------------------------	-----	----------

CAE data

EPLAN Data Portal 2210-1301	URL	Download
-----------------------------	-----	----------

Subject to changes. Please also observe the further product documentation!

WAGO Kontakttechnik GmbH & Co. KG
 Hansastr. 27
 32423 Minden
 Phone: +49571 887-0 | Fax: +49571 887-169
 Email: info.de@wago.com | Web: www.wago.com

Do you have any questions about our products?
 We are always happy to take your call at +49 (571) 887-44222.

Installation Notes

Inserting a conductor

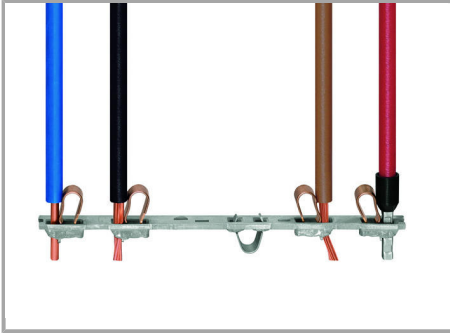

All conductor types at a glance

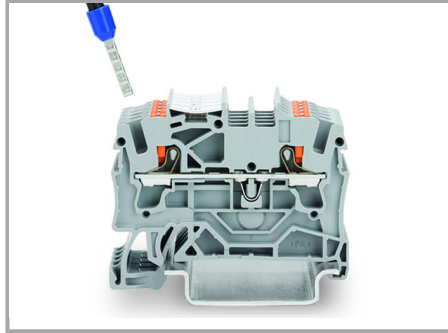

Push-in termination of solid and ferruled conductors



Insert fine-stranded conductors via operating tool.



Removing all conductors via operating tool.

Jumpered

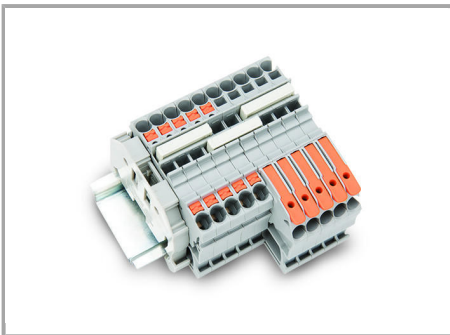

Insert push-in type jumper bar and push down until it hits backstop.

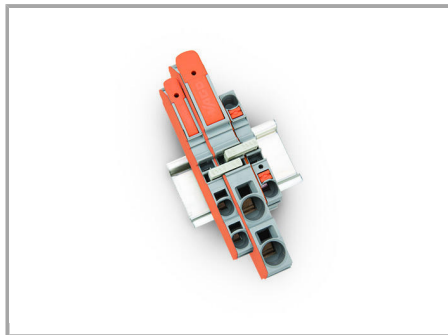

Commoning with step-down jumpers.

Testing

Subject to changes. Please also observe the further product documentation!

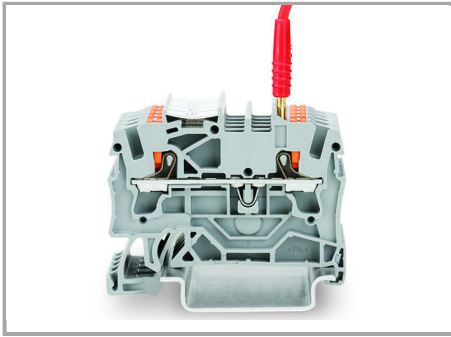

Testing with a 2 mm Ø test plug (max. 42 V).

Marking

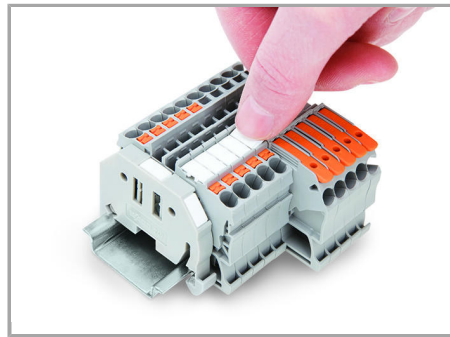
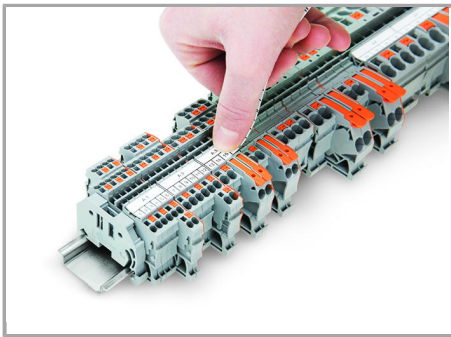

Snapping a marking strip into the marker slot.

Snapping a marking strip into the marker slot.

Product family

TOPJOB® S

TOPJOB® S: In various industrial applications and modern building installations, WAGO's wide and versatile range of rail-mount terminal blocks provides more than just reliable electrical connections.

[Learn more about the product family.](#)

[Show all products from the family](#)

Subject to changes. Please also observe the further product documentation!