

## Data sheet | Item number: 2202-1604

2-conductor through terminal block; with push-button; 2.5 mm<sup>2</sup>; with test option; same profile as 2-conductor disconnect terminal block; side and center marking; for DIN-rail 35 x 15 and 35 x 7.5; Push-in CAGE CLAMP®; 2,50 mm<sup>2</sup>; blue

[www.wago.com/2202-1604](http://www.wago.com/2202-1604)

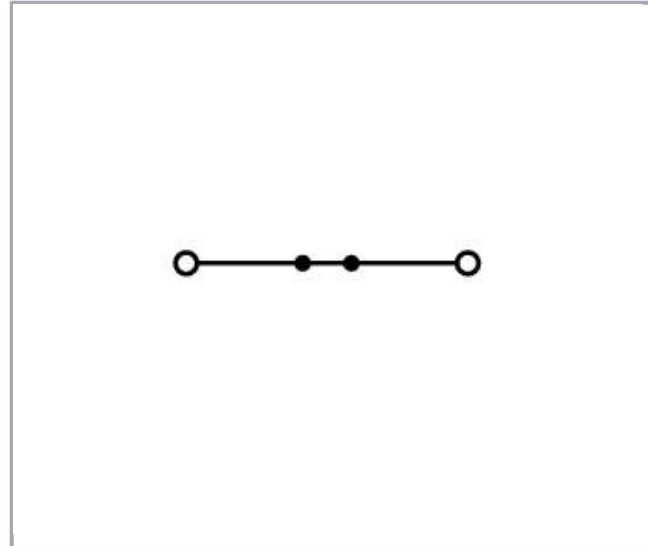
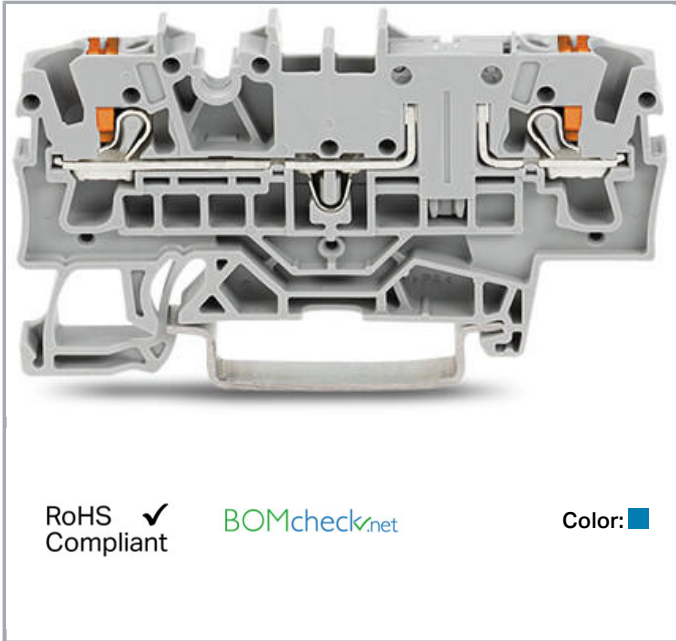

### Data

#### Electrical data

#### Ratings per IEC/EN 60664-1

Ratings per	IEC/EN 60947-7-1
Rated voltage (III / 3)	400 V
Rated impulse voltage (III / 3)	6 kV
Rated current	16 A
Legend (ratings)	(III / 3) ≙ Overvoltage category III / Pollution degree 3

#### Connection data

Connection technology	Push-in CAGE CLAMP®
Actuation type	Push-in Push-button Operating tool
Connectable conductor materials	Copper
Nominal cross section	2,5 mm <sup>2</sup>

Subject to changes. Please also observe the further product documentation!

WAGO Kontakttechnik GmbH & Co. KG  
Hansastr. 27  
32423 Minden  
Phone: +49571 887-0 | Fax: +49571 887-169  
Email: [info.de@wago.com](mailto:info.de@wago.com) | Web: [www.wago.com](http://www.wago.com)

Do you have any questions about our products?  
We are always happy to take your call at +49 (571) 887-44222.



Solid conductor	0,25 ... 4 mm <sup>2</sup> / 22 ... 12 AWG
Solid conductor, push-in termination	0,75 ... 4 mm <sup>2</sup> / 18 ... 12 AWG
Fine-stranded conductor	0,25 ... 4 mm <sup>2</sup> / 22 ... 12 AWG
Fine-stranded conductor with ferrule with plastic collar	1 ... 2,5 mm <sup>2</sup> / 18 ... 12 AWG
Fine-stranded conductor with ferrule, push-in termination, from	1 ... 2,5 mm <sup>2</sup> / 18 ... 12 AWG
Strip length	10 ... 12 mm / 0.39 ... 0.47 inch
Total number of connection points	2
Total number of potentials	1
Number of levels	1
Type of wiring	Front-entry wiring
Note (conductor cross-section)	Depending on the conductor characteristic, a conductor with a smaller cross-section can also be inserted via push-in termination.
Number of jumper slots	2

### Geometrical Data

Width	5,2 mm / 0.205 inch
Height from upper-edge of DIN-35 rail	32,9 mm / 1.295 inch
Depth	66,1 mm / 2.602 inch

### Mechanical data

Design	horizontal type
Type of mounting	DIN-35 rail
Marking level	Center/side marking

### Material Data

Color	blue
Insulating material	Polyamide 66 (PA 66)
Weight	7.9 g

### Commercial data

Packaging type	BOX
Country of origin	DE
GTIN	4055143907644
Customs Tariff No.	85369010000

### Counterpart





Subject to changes. Please also observe the further product documentation!

WAGO Kontakttechnik GmbH & Co. KG  
 Hansastr. 27  
 32423 Minden  
 Phone: +49571 887-0 | Fax: +49571 887-169  
 Email: [info.de@wago.com](mailto:info.de@wago.com) | Web: [www.wago.com](http://www.wago.com)

Do you have any questions about our products?  
 We are always happy to take your call at +49 (571) 887-44222.

## Compatible products

### Carrier rail

	<b>Item no.: 210-112</b> Steel carrier rail; 35 x 7.5 mm; 1 mm thick; 2 m long; slotted; according to EN 60715; "Hole width 25 mm	<a href="http://www.wago.com/210-112">www.wago.com/210-112</a>
	<b>Item no.: 210-113</b> Steel carrier rail; 35 x 7.5 mm; 1 mm thick; 2 m long; unslotted; according to EN 60715	<a href="http://www.wago.com/210-113">www.wago.com/210-113</a>
	<b>Item no.: 210-114</b> Steel carrier rail; 35 x 15 mm; 1.5 mm thick; 2 m long; unslotted; similar to EN 60715	<a href="http://www.wago.com/210-114">www.wago.com/210-114</a>
	<b>Item no.: 210-115</b> Steel carrier rail; 35 x 7.5 mm; 1 mm thick; 2 m long; slotted; according to EN 60715; "Hole width 18 mm	<a href="http://www.wago.com/210-115">www.wago.com/210-115</a>
	<b>Item no.: 210-118</b> Steel carrier rail; 35 x 15 mm; 2.3 mm thick; 2 m long; unslotted; according to EN 60715	<a href="http://www.wago.com/210-118">www.wago.com/210-118</a>
	<b>Item no.: 210-196</b> Aluminum carrier rail; 35 x 8.2 mm; 1.6 mm thick; 2 m long; unslotted; similar to EN 60715; silver-colored	<a href="http://www.wago.com/210-196">www.wago.com/210-196</a>
	<b>Item no.: 210-197</b> Steel carrier rail; 35 x 15 mm; 1.5 mm thick; 2 m long; slotted; similar to EN 60715	<a href="http://www.wago.com/210-197">www.wago.com/210-197</a>
	<b>Item no.: 210-198</b> Copper carrier rail; 35 x 15 mm; 2.3 mm thick; 2 m long; unslotted; according to EN 60715; copper-colored	<a href="http://www.wago.com/210-198">www.wago.com/210-198</a>
	<b>Item no.: 210-504</b> Steel carrier rail; 35 x 7.5 mm; 1 mm thick; 2 m long; slotted; galvanized; according to EN 60715	<a href="http://www.wago.com/210-504">www.wago.com/210-504</a>
	<b>Item no.: 210-505</b> Steel carrier rail; 35 x 7.5 mm; 1 mm thick; 2 m long; unslotted; galvanized; according to EN 60715	<a href="http://www.wago.com/210-505">www.wago.com/210-505</a>
	<b>Item no.: 210-506</b> Steel carrier rail; 35 x 15 mm; 1.5 mm thick; 2 m long; unslotted; galvanized; similar to EN 60715	<a href="http://www.wago.com/210-506">www.wago.com/210-506</a>
	<b>Item no.: 210-508</b> Steel carrier rail; 35 x 15 mm; 1.5 mm thick; 2 m long; slotted; galvanized; similar to EN 60715	<a href="http://www.wago.com/210-508">www.wago.com/210-508</a>

### End plate

Subject to changes. Please also observe the further product documentation!

**Item no.: 2002-1691**  
End and intermediate plate; 1 mm thick; gray

[www.wago.com/2002-1691](http://www.wago.com/2002-1691)

**Item no.: 2002-1692**  
End and intermediate plate; 1 mm thick; orange

[www.wago.com/2002-1692](http://www.wago.com/2002-1692)

**Marking accessories**



**Item no.: 2002-121**  
Adaptor

[www.wago.com/2002-121](http://www.wago.com/2002-121)



**Item no.: 2002-161**  
Adaptor

[www.wago.com/2002-161](http://www.wago.com/2002-161)

**Item no.: 2009-110**  
Marking strips; on reel; not stretchable; plain; snap-on type; white

[www.wago.com/2009-110](http://www.wago.com/2009-110)

**Item no.: 2009-115**  
WMB-Inline; for Smart Printer; 1500 pieces on roll; stretchable 5 - 5.2 mm; plain; snap-on type; white

[www.wago.com/2009-115](http://www.wago.com/2009-115)

**Item no.: 2009-115/000-002**  
WMB-Inline; for Smart Printer; 1500 pieces on roll; stretchable 5 - 5.2 mm; plain; snap-on type; yellow

[www.wago.com/2009-115/000-002](http://www.wago.com/2009-115/000-002)



**Item no.: 2009-115/000-005**  
WMB-Inline; for Smart Printer; 1500 pieces on roll; stretchable 5 - 5.2 mm; plain; snap-on type; white

[www.wago.com/2009-115/000-005](http://www.wago.com/2009-115/000-005)

**Item no.: 2009-115/000-006**  
WMB-Inline; for Smart Printer; 1500 pieces on roll; stretchable 5 - 5.2 mm; plain; snap-on type; white

[www.wago.com/2009-115/000-006](http://www.wago.com/2009-115/000-006)

**Item no.: 2009-115/000-007**  
WMB-Inline; for Smart Printer; 1500 pieces on roll; stretchable 5 - 5.2 mm; plain; snap-on type; gray

[www.wago.com/2009-115/000-007](http://www.wago.com/2009-115/000-007)

**Item no.: 2009-115/000-012**  
WMB-Inline; for Smart Printer; 1500 pieces on roll; stretchable 5 - 5.2 mm; plain; snap-on type; white

[www.wago.com/2009-115/000-012](http://www.wago.com/2009-115/000-012)



**Item no.: 2009-115/000-017**  
WMB-Inline; for Smart Printer; 1500 pieces on roll; stretchable 5 - 5.2 mm; plain; snap-on type; white

[www.wago.com/2009-115/000-017](http://www.wago.com/2009-115/000-017)



**Item no.: 2009-115/000-023**  
WMB-Inline; for Smart Printer; 1500 pieces on roll; stretchable 5 - 5.2 mm; plain; snap-on type; green

[www.wago.com/2009-115/000-023](http://www.wago.com/2009-115/000-023)

**Item no.: 2009-115/000-024**  
WMB-Inline; for Smart Printer; 1500 pieces on roll; stretchable 5 - 5.2 mm; plain; snap-on type; white









[www.wago.com/2009-115/000-024](http://www.wago.com/2009-115/000-024)













**Item no.: 2009-145**  
Mini-WSB Inline; for Smart Printer; 1700 pieces on roll; stretchable 5 - 5.2 mm; plain; snap-on type; white

[www.wago.com/2009-145](http://www.wago.com/2009-145)

Subject to changes. Please also observe the further product documentation!

	<b>Item no.: 2009-145/000-002</b> Mini-WSB Inline; for Smart Printer; 1700 pieces on roll; stretchable 5 - 5.2 mm; plain; snap-on type; white	<a href="http://www.wago.com/2009-145/000-002">www.wago.com/2009-145/000-002</a>
	<b>Item no.: 2009-145/000-005</b> Mini-WSB Inline; for Smart Printer; 1700 pieces on roll; stretchable 5 - 5.2 mm; plain; snap-on type; red	<a href="http://www.wago.com/2009-145/000-005">www.wago.com/2009-145/000-005</a>
	<b>Item no.: 2009-145/000-006</b> Mini-WSB Inline; for Smart Printer; 1700 pieces on roll; stretchable 5 - 5.2 mm; plain; snap-on type; blue	<a href="http://www.wago.com/2009-145/000-006">www.wago.com/2009-145/000-006</a>
	<b>Item no.: 2009-145/000-007</b> Mini-WSB Inline; for Smart Printer; 1700 pieces on roll; stretchable 5 - 5.2 mm; plain; snap-on type; white	<a href="http://www.wago.com/2009-145/000-007">www.wago.com/2009-145/000-007</a>
	<b>Item no.: 2009-145/000-012</b> Mini-WSB Inline; for Smart Printer; 1700 pieces on roll; stretchable 5 - 5.2 mm; plain; snap-on type; orange	<a href="http://www.wago.com/2009-145/000-012">www.wago.com/2009-145/000-012</a>
	<b>Item no.: 2009-145/000-023</b> Mini-WSB Inline; for Smart Printer; 1700 pieces on roll; stretchable 5 - 5.2 mm; plain; snap-on type; green	<a href="http://www.wago.com/2009-145/000-023">www.wago.com/2009-145/000-023</a>
	<b>Item no.: 2009-145/000-024</b> Mini-WSB Inline; for Smart Printer; 1700 pieces on roll; stretchable 5 - 5.2 mm; plain; snap-on type; violet	<a href="http://www.wago.com/2009-145/000-024">www.wago.com/2009-145/000-024</a>
	<b>Item no.: 2009-191</b> Group marker carrier	<a href="http://www.wago.com/2009-191">www.wago.com/2009-191</a>
	<b>Item no.: 2009-192</b> Group marker carrier	<a href="http://www.wago.com/2009-192">www.wago.com/2009-192</a>
	<b>Item no.: 2009-193</b> Group marker carrier	<a href="http://www.wago.com/2009-193">www.wago.com/2009-193</a>
	<b>Item no.: 2009-198</b> Adaptor	<a href="http://www.wago.com/2009-198">www.wago.com/2009-198</a>
	<b>Item no.: 248-501</b> Miniature WSB Quick marking system; plain; Marker width 5 mm; 10 strips with 10 markers per card	<a href="http://www.wago.com/248-501">www.wago.com/248-501</a>
	<b>Item no.: 248-501/000-002</b> Mini-WSB marking card; as card; not stretchable; plain; snap-on type; yellow	<a href="http://www.wago.com/248-501/000-002">www.wago.com/248-501/000-002</a>
	<b>Item no.: 248-501/000-005</b> Mini-WSB marking card; as card; not stretchable; plain; snap-on type; red	<a href="http://www.wago.com/248-501/000-005">www.wago.com/248-501/000-005</a>
	<b>Item no.: 248-501/000-006</b> Mini-WSB marking card; as card; not stretchable; plain; snap-on type; blue	<a href="http://www.wago.com/248-501/000-006">www.wago.com/248-501/000-006</a>

Subject to changes. Please also observe the further product documentation!

	<p><b>Item no.: 248-501/000-007</b>                  Mini-WSB marking card; as card; not stretchable; plain; snap-on type; gray</p>	<p><a href="http://www.wago.com/248-501/000-007">www.wago.com/248-501/000-007</a></p>
	<p><b>Item no.: 248-501/000-012</b>                  Mini-WSB marking card; as card; not stretchable; plain; snap-on type; orange</p>	<p><a href="http://www.wago.com/248-501/000-012">www.wago.com/248-501/000-012</a></p>
	<p><b>Item no.: 248-501/000-017</b>                  Mini-WSB marking card; as card; not stretchable; plain; snap-on type; light green</p>	<p><a href="http://www.wago.com/248-501/000-017">www.wago.com/248-501/000-017</a></p>
	<p><b>Item no.: 248-501/000-023</b>                  Mini-WSB marking card; as card; not stretchable; plain; snap-on type; green</p>	<p><a href="http://www.wago.com/248-501/000-023">www.wago.com/248-501/000-023</a></p>
	<p><b>Item no.: 248-501/000-024</b>                  Mini-WSB marking card; as card; not stretchable; plain; snap-on type; violet</p>	<p><a href="http://www.wago.com/248-501/000-024">www.wago.com/248-501/000-024</a></p>
	<p><b>Item no.: 793-501</b>                  WMB marking card; as card; not stretchable; plain; snap-on type; white</p>	<p><a href="http://www.wago.com/793-501">www.wago.com/793-501</a></p>
	<p><b>Item no.: 793-501/000-002</b>                  WMB marking card; as card; not stretchable; plain; snap-on type; yellow</p>	<p><a href="http://www.wago.com/793-501/000-002">www.wago.com/793-501/000-002</a></p>
	<p><b>Item no.: 793-501/000-005</b>                  WMB marking card; as card; not stretchable; plain; snap-on type; red</p>	<p><a href="http://www.wago.com/793-501/000-005">www.wago.com/793-501/000-005</a></p>
	<p><b>Item no.: 793-501/000-006</b>                  WMB marking card; as card; not stretchable; plain; snap-on type; blue</p>	<p><a href="http://www.wago.com/793-501/000-006">www.wago.com/793-501/000-006</a></p>
	<p><b>Item no.: 793-501/000-007</b>                  WMB marking card; as card; not stretchable; plain; snap-on type; gray</p>	<p><a href="http://www.wago.com/793-501/000-007">www.wago.com/793-501/000-007</a></p>
	<p><b>Item no.: 793-501/000-012</b>                  WMB marking card; as card; not stretchable; plain; snap-on type; orange</p>	<p><a href="http://www.wago.com/793-501/000-012">www.wago.com/793-501/000-012</a></p>
	<p><b>Item no.: 793-501/000-017</b>                  WMB marking card; as card; not stretchable; plain; snap-on type; light green</p>	<p><a href="http://www.wago.com/793-501/000-017">www.wago.com/793-501/000-017</a></p>
	<p><b>Item no.: 793-501/000-023</b>                  WMB marking card; as card; not stretchable; plain; snap-on type; green</p>	<p><a href="http://www.wago.com/793-501/000-023">www.wago.com/793-501/000-023</a></p>

Subject to changes. Please also observe the further product documentation!



**Item no.: 793-501/000-024**  
WMB marking card; as card; not stretchable; plain; snap-on type; violet

[www.wago.com/793-501/000-024](http://www.wago.com/793-501/000-024)



**Item no.: 793-5501**  
WMB marking card; as card; for terminal block width 5 - 17.5 mm; stretchable 5 - 5.2 mm; plain; snap-on type; white

[www.wago.com/793-5501](http://www.wago.com/793-5501)

**Item no.: 793-5501/000-002**  
WMB marking card; as card; for terminal block width 5 - 17.5 mm; stretchable 5 - 5.2 mm; plain; snap-on type; yellow

[www.wago.com/793-5501/000-002](http://www.wago.com/793-5501/000-002)

**Item no.: 793-5501/000-005**  
WMB marking card; as card; for terminal block width 5 - 17.5 mm; stretchable 5 - 5.2 mm; plain; snap-on type; red

[www.wago.com/793-5501/000-005](http://www.wago.com/793-5501/000-005)



**Item no.: 793-5501/000-006**  
WMB marking card; as card; for terminal block width 5 - 17.5 mm; stretchable 5 - 5.2 mm; plain; snap-on type; blue

[www.wago.com/793-5501/000-006](http://www.wago.com/793-5501/000-006)



**Item no.: 793-5501/000-007**  
WMB marking card; as card; for terminal block width 5 - 17.5 mm; stretchable 5 - 5.2 mm; plain; snap-on type; gray

[www.wago.com/793-5501/000-007](http://www.wago.com/793-5501/000-007)



**Item no.: 793-5501/000-012**  
WMB marking card; as card; for terminal block width 5 - 17.5 mm; stretchable 5 - 5.2 mm; plain; snap-on type; orange

[www.wago.com/793-5501/000-012](http://www.wago.com/793-5501/000-012)



**Item no.: 793-5501/000-014**  
WMB marking card; as card; for terminal block width 5 - 17.5 mm; stretchable 5 - 5.2 mm; plain; snap-on type; brown

[www.wago.com/793-5501/000-014](http://www.wago.com/793-5501/000-014)



**Item no.: 793-5501/000-017**  
WMB marking card; as card; for terminal block width 5 - 17.5 mm; stretchable 5 - 5.2 mm; plain; snap-on type; green

[www.wago.com/793-5501/000-017](http://www.wago.com/793-5501/000-017)



**Item no.: 793-5501/000-023**  
WMB marking card; as card; for terminal block width 5 - 17.5 mm; stretchable 5 - 5.2 mm; plain; snap-on type; light green

[www.wago.com/793-5501/000-023](http://www.wago.com/793-5501/000-023)



**Item no.: 793-5501/000-024**  
WMB marking card; as card; for terminal block width 5 - 17.5 mm; stretchable 5 - 5.2 mm; plain; snap-on type; violet

[www.wago.com/793-5501/000-024](http://www.wago.com/793-5501/000-024)

#### Jumper



**Item no.: 2002-400**  
Adjacent jumper for continuous commoning; insulated; 2-way; Nominal current 25 A; light gray

[www.wago.com/2002-400](http://www.wago.com/2002-400)









**Item no.: 2002-402**  
Push-in type jumper bar; insulated; 2-way; Nominal current 25 A; light gray

[www.wago.com/2002-402](http://www.wago.com/2002-402)

**Item no.: 2002-402/000-005**  
Push-in type jumper bar; insulated; 2-way; Nominal current 25 A; red

[www.wago.com/2002-402/000-005](http://www.wago.com/2002-402/000-005)

Subject to changes. Please also observe the further product documentation!

	<b>Item no.: 2002-402/000-006</b> Push-in type jumper bar; insulated; 2-way; Nominal current 25 A; blue	<a href="http://www.wago.com/2002-402/000-006">www.wago.com/2002-402/000-006</a>
	<b>Item no.: 2002-403</b> Push-in type jumper bar; insulated; 3-way; Nominal current 25 A; light gray	<a href="http://www.wago.com/2002-403">www.wago.com/2002-403</a>
	<b>Item no.: 2002-403/000-005</b> Push-in type jumper bar; insulated; 3-way; Nominal current 25 A; red	<a href="http://www.wago.com/2002-403/000-005">www.wago.com/2002-403/000-005</a>
	<b>Item no.: 2002-403/000-006</b> Push-in type jumper bar; insulated; 3-way; Nominal current 25 A; blue	<a href="http://www.wago.com/2002-403/000-006">www.wago.com/2002-403/000-006</a>
	<b>Item no.: 2002-404</b> Push-in type jumper bar; insulated; 4-way; Nominal current 25 A; light gray	<a href="http://www.wago.com/2002-404">www.wago.com/2002-404</a>
	<b>Item no.: 2002-404/000-005</b> Push-in type jumper bar; insulated; 4-way; Nominal current 25 A; red	<a href="http://www.wago.com/2002-404/000-005">www.wago.com/2002-404/000-005</a>
	<b>Item no.: 2002-404/000-006</b> Push-in type jumper bar; insulated; 4-way; Nominal current 25 A; blue	<a href="http://www.wago.com/2002-404/000-006">www.wago.com/2002-404/000-006</a>
	<b>Item no.: 2002-405</b> Push-in type jumper bar; insulated; 5-way; Nominal current 25 A; light gray	<a href="http://www.wago.com/2002-405">www.wago.com/2002-405</a>
	<b>Item no.: 2002-405/000-005</b> Push-in type jumper bar; insulated; 5-way; Nominal current 25 A; red	<a href="http://www.wago.com/2002-405/000-005">www.wago.com/2002-405/000-005</a>
	<b>Item no.: 2002-405/000-006</b> Push-in type jumper bar; insulated; 5-way; Nominal current 25 A; blue	<a href="http://www.wago.com/2002-405/000-006">www.wago.com/2002-405/000-006</a>
	<b>Item no.: 2002-405/011-000</b> Star point jumper; insulated; 3-way (1-3-5); IN = IN terminal block; light gray	<a href="http://www.wago.com/2002-405/011-000">www.wago.com/2002-405/011-000</a>
	<b>Item no.: 2002-406</b> Push-in type jumper bar; insulated; 6-way; Nominal current 25 A; light gray	<a href="http://www.wago.com/2002-406">www.wago.com/2002-406</a>
	<b>Item no.: 2002-406/000-005</b> Push-in type jumper bar; insulated; 6-way; Nominal current 25 A; red	<a href="http://www.wago.com/2002-406/000-005">www.wago.com/2002-406/000-005</a>
	<b>Item no.: 2002-406/000-006</b> Push-in type jumper bar; insulated; 6-way; Nominal current 25 A; blue	<a href="http://www.wago.com/2002-406/000-006">www.wago.com/2002-406/000-006</a>

Subject to changes. Please also observe the further product documentation!





**Item no.: 2002-406/020-000**  
Delta jumper; insulated; 1-2 3-4 5-6; IN = IN terminal block; light gray

[www.wago.com/2002-406/020-000](http://www.wago.com/2002-406/020-000)



**Item no.: 2002-407**  
Push-in type jumper bar; insulated; 7-way; Nominal current 25 A; light gray

[www.wago.com/2002-407](http://www.wago.com/2002-407)

**Item no.: 2002-407/000-005**  
Push-in type jumper bar; insulated; 7-way; Nominal current 25 A; red

[www.wago.com/2002-407/000-005](http://www.wago.com/2002-407/000-005)

**Item no.: 2002-407/000-006**  
Push-in type jumper bar; insulated; 7-way; Nominal current 25 A; blue

[www.wago.com/2002-407/000-006](http://www.wago.com/2002-407/000-006)



**Item no.: 2002-408**  
Push-in type jumper bar; insulated; 8-way; Nominal current 25 A; light gray

[www.wago.com/2002-408](http://www.wago.com/2002-408)



**Item no.: 2002-408/000-005**  
Push-in type jumper bar; insulated; 8-way; Nominal current 25 A; red

[www.wago.com/2002-408/000-005](http://www.wago.com/2002-408/000-005)



**Item no.: 2002-408/000-006**  
Push-in type jumper bar; insulated; 8-way; Nominal current 25 A; blue

[www.wago.com/2002-408/000-006](http://www.wago.com/2002-408/000-006)



**Item no.: 2002-409**  
Push-in type jumper bar; insulated; 9-way; Nominal current 25 A; light gray

[www.wago.com/2002-409](http://www.wago.com/2002-409)



**Item no.: 2002-409/000-005**  
Push-in type jumper bar; insulated; 9-way; Nominal current 25 A; red

[www.wago.com/2002-409/000-005](http://www.wago.com/2002-409/000-005)

**Item no.: 2002-409/000-006**  
Push-in type jumper bar; insulated; 9-way; Nominal current 25 A; blue

[www.wago.com/2002-409/000-006](http://www.wago.com/2002-409/000-006)

**Item no.: 2002-410**  
Push-in type jumper bar; insulated; 10-way; Nominal current 25 A; light gray

[www.wago.com/2002-410](http://www.wago.com/2002-410)



**Item no.: 2002-410/000-005**  
Push-in type jumper bar; insulated; 10-way; Nominal current 25 A; red

[www.wago.com/2002-410/000-005](http://www.wago.com/2002-410/000-005)



**Item no.: 2002-410/000-006**  
Push-in type jumper bar; insulated; 10-way; Nominal current 25 A; blue

[www.wago.com/2002-410/000-006](http://www.wago.com/2002-410/000-006)









**Item no.: 2002-423**  
Adjacent jumper for continuous commoning; insulated; from 1 to 3; Nominal current 25 A; light gray

[www.wago.com/2002-423](http://www.wago.com/2002-423)









**Item no.: 2002-423/000-005**  
Adjacent jumper for continuous commoning; insulated; from 1 to 3; Nominal current 25 A; red

[www.wago.com/2002-423/000-005](http://www.wago.com/2002-423/000-005)

Subject to changes. Please also observe the further product documentation!

	<b>Item no.: 2002-423/000-006</b> Adjacent jumper for continuous commoning; insulated; from 1 to 3; Nominal current 25 A; blue	<a href="http://www.wago.com/2002-423/000-006">www.wago.com/2002-423/000-006</a>
	<b>Item no.: 2002-433</b> Push-in type jumper bar; insulated; from 1 to 3; Nominal current 25 A; light gray	<a href="http://www.wago.com/2002-433">www.wago.com/2002-433</a>
	<b>Item no.: 2002-434</b> Push-in type jumper bar; insulated; from 1 to 4; Nominal current 25 A; light gray	<a href="http://www.wago.com/2002-434">www.wago.com/2002-434</a>
	<b>Item no.: 2002-435</b> Push-in type jumper bar; insulated; from 1 to 5; Nominal current 25 A; light gray	<a href="http://www.wago.com/2002-435">www.wago.com/2002-435</a>
	<b>Item no.: 2002-436</b> Push-in type jumper bar; insulated; from 1 to 6; Nominal current 25 A; light gray	<a href="http://www.wago.com/2002-436">www.wago.com/2002-436</a>
	<b>Item no.: 2002-437</b> Push-in type jumper bar; insulated; from 1 to 7; Nominal current 25 A; light gray	<a href="http://www.wago.com/2002-437">www.wago.com/2002-437</a>
	<b>Item no.: 2002-438</b> Push-in type jumper bar; insulated; from 1 to 8; Nominal current 25 A; light gray	<a href="http://www.wago.com/2002-438">www.wago.com/2002-438</a>
	<b>Item no.: 2002-439</b> Push-in type jumper bar; insulated; from 1 to 9; Nominal current 25 A; light gray	<a href="http://www.wago.com/2002-439">www.wago.com/2002-439</a>
	<b>Item no.: 2002-440</b> Push-in type jumper bar; insulated; from 1 to 10; Nominal current 25 A; light gray	<a href="http://www.wago.com/2002-440">www.wago.com/2002-440</a>
	<b>Item no.: 2002-472</b> Staggered jumper; insulated; 2-way; Nominal current 25 A; suitable for 2002 and 2003 Series rail-mounted terminal blocks; light gray	<a href="http://www.wago.com/2002-472">www.wago.com/2002-472</a>
	<b>Item no.: 2002-473</b> Staggered jumper; insulated; 3-way; Nominal current 25 A; suitable for 2002 and 2003 Series rail-mounted terminal blocks; light gray	<a href="http://www.wago.com/2002-473">www.wago.com/2002-473</a>
	<b>Item no.: 2002-473/011-000</b> Ready-made staggered jumper; insulated; 2-way (1-3); Nominal current 25 A; with contact lugs broken off at the factory and circuit marking; light gray	<a href="http://www.wago.com/2002-473/011-000">www.wago.com/2002-473/011-000</a>
	<b>Item no.: 2002-474</b> Staggered jumper; insulated; 4-way; Nominal current 25 A; suitable for 2002 and 2003 Series rail-mounted terminal blocks; light gray	<a href="http://www.wago.com/2002-474">www.wago.com/2002-474</a>
	<b>Item no.: 2002-475</b> Staggered jumper; insulated; 5-way; Nominal current 25 A; suitable for 2002 and 2003 Series rail-mounted terminal blocks; light gray	<a href="http://www.wago.com/2002-475">www.wago.com/2002-475</a>
	<b>Item no.: 2002-475/011-000</b> Ready-made staggered jumper; insulated; 3-way (1-3-5); Nominal current 25 A; with contact lugs broken off at the factory and circuit marking; light gray	<a href="http://www.wago.com/2002-475/011-000">www.wago.com/2002-475/011-000</a>
	<b>Item no.: 2002-476</b> Staggered jumper; insulated; 6-way; Nominal current 25 A; suitable for 2002 and 2003 Series rail-mounted terminal blocks; light gray	<a href="http://www.wago.com/2002-476">www.wago.com/2002-476</a>
	<b>Item no.: 2002-477</b>	

Subject to changes. Please also observe the further product documentation!

	Staggered jumper; insulated; 7-way; Nominal current 25 A; suitable for 2002 and 2003 Series rail-mounted terminal blocks; light gray	<a href="http://www.wago.com/2002-477">www.wago.com/2002-477</a>
	<b>Item no.: 2002-477/011-000</b> Ready-made staggered jumper; insulated; 1-3-5-7; Nominal current 25 A; with contact lugs broken off at the factory and circuit marking; light gray	<a href="http://www.wago.com/2002-477/011-000">www.wago.com/2002-477/011-000</a>
	<b>Item no.: 2002-478</b> Staggered jumper; insulated; 8-way; Nominal current 25 A; suitable for 2002 and 2003 Series rail-mounted terminal blocks; light gray	<a href="http://www.wago.com/2002-478">www.wago.com/2002-478</a>
	<b>Item no.: 2002-479</b> Staggered jumper; insulated; 9-way; Nominal current 25 A; suitable for 2002 and 2003 Series rail-mounted terminal blocks; light gray	<a href="http://www.wago.com/2002-479">www.wago.com/2002-479</a>
	<b>Item no.: 2002-479/011-000</b> Ready-made staggered jumper; insulated; 1-3-5-7-9; Nominal current 25 A; with contact lugs broken off at the factory and circuit marking; light gray	<a href="http://www.wago.com/2002-479/011-000">www.wago.com/2002-479/011-000</a>
	<b>Item no.: 2002-480</b> Staggered jumper; insulated; 10-way; Nominal current 25 A; suitable for 2002 and 2003 Series rail-mounted terminal blocks; light gray	<a href="http://www.wago.com/2002-480">www.wago.com/2002-480</a>
	<b>Item no.: 2002-481</b> Staggered jumper; insulated; 11-way; Nominal current 25 A; suitable for 2002 and 2003 Series rail-mounted terminal blocks; light gray	<a href="http://www.wago.com/2002-481">www.wago.com/2002-481</a>
	<b>Item no.: 2002-481/011-000</b> Ready-made staggered jumper; insulated; 1-3-5-7-9-11; Nominal current 25 A; with contact lugs broken off at the factory and circuit marking; light gray	<a href="http://www.wago.com/2002-481/011-000">www.wago.com/2002-481/011-000</a>
	<b>Item no.: 2002-482</b> Staggered jumper; insulated; 12-way; Nominal current 25 A; suitable for 2002 and 2003 Series rail-mounted terminal blocks; light gray	<a href="http://www.wago.com/2002-482">www.wago.com/2002-482</a>
	<b>Item no.: 210-103</b> Wire commoning chain; insulated; 50 connections; black	<a href="http://www.wago.com/210-103">www.wago.com/210-103</a>
	<b>Item no.: 210-123</b> Wire commoning chain; insulated; 50 connections	<a href="http://www.wago.com/210-123">www.wago.com/210-123</a>
<b>plug</b>		
	<b>Item no.: 2002-880</b> Empty component plug housing; 10.4 mm wide; 2-pole; Type 4; gray	<a href="http://www.wago.com/2002-880">www.wago.com/2002-880</a>
	<b>Item no.: 2002-880/1000-411</b> Component plug; 2-pole; with diode 1N4007; 10.4 mm wide; Operating temperature 85°C max.; gray	<a href="http://www.wago.com/2002-880/1000-411">www.wago.com/2002-880/1000-411</a>
	<b>Item no.: 2002-880/1000-541</b> Component plug; 2-pole; LED (red); 10.4 mm wide; Operating temperature 85°C max.; gray	<a href="http://www.wago.com/2002-880/1000-541">www.wago.com/2002-880/1000-541</a>
	<b>Item no.: 2002-880/1000-542</b> LED module; with red LED; 10.4 mm wide; 30 - 65 V; Operating temperature 85°C max.	<a href="http://www.wago.com/2002-880/1000-542">www.wago.com/2002-880/1000-542</a>



Subject to changes. Please also observe the further product documentation!

Item no.: 2002-880/1000-836

Component plug; 2-pole; LED (red); 10.4 mm wide; Operating temperature 85°C max.; gray

[www.wago.com/2002-880](http://www.wago.com/2002-880)[/1000-836](http://www.wago.com/1000-836)

## ferrule

	<b>Item no.: 216-241</b> Ferrule; Sleeve for 0.5 mm <sup>2</sup> / 20 AWG; insulated; electro-tin plated; electrolytic copper; gastight crimped; acc. to DIN 46228, Part 4/09.90; white	<a href="http://www.wago.com/216-241">www.wago.com/216-241</a>
	<b>Item no.: 216-242</b> Ferrule; Sleeve for 0.75 mm <sup>2</sup> / 18 AWG; insulated; electro-tin plated; electrolytic copper; gastight crimped; acc. to DIN 46228, Part 4/09.90; gray	<a href="http://www.wago.com/216-242">www.wago.com/216-242</a>
	<b>Item no.: 216-243</b> Ferrule; Sleeve for 1 mm <sup>2</sup> / AWG 18; insulated; electro-tin plated; electrolytic copper; gastight crimped; acc. to DIN 46228, Part 4/09.90; red	<a href="http://www.wago.com/216-243">www.wago.com/216-243</a>
	<b>Item no.: 216-244</b> Ferrule; Sleeve for 1.5 mm <sup>2</sup> / AWG 16; insulated; electro-tin plated; electrolytic copper; gastight crimped; acc. to DIN 46228, Part 4/09.90; black	<a href="http://www.wago.com/216-244">www.wago.com/216-244</a>
	<b>Item no.: 216-246</b> Ferrule; Sleeve for 2.5 mm <sup>2</sup> / AWG 14; insulated; electro-tin plated; electrolytic copper; gastight crimped; acc. to DIN 46228, Part 4/09.90; blue	<a href="http://www.wago.com/216-246">www.wago.com/216-246</a>
	<b>Item no.: 216-262</b> Ferrule; Sleeve for 0.75 mm <sup>2</sup> / 18 AWG; insulated; electro-tin plated; electrolytic copper; gastight crimped; acc. to DIN 46228, Part 4/09.90; gray	<a href="http://www.wago.com/216-262">www.wago.com/216-262</a>
	<b>Item no.: 216-263</b> Ferrule; Sleeve for 1 mm <sup>2</sup> / AWG 18; insulated; electro-tin plated; electrolytic copper; gastight crimped; acc. to DIN 46228, Part 4/09.90; red	<a href="http://www.wago.com/216-263">www.wago.com/216-263</a>
	<b>Item no.: 216-264</b> Ferrule; Sleeve for 1.5 mm <sup>2</sup> / AWG 16; insulated; electro-tin plated; electrolytic copper; gastight crimped; acc. to DIN 46228, Part 4/09.90; black	<a href="http://www.wago.com/216-264">www.wago.com/216-264</a>
	<b>Item no.: 216-266</b> Ferrule; Sleeve for 2.5 mm <sup>2</sup> / AWG 14; insulated; electro-tin plated; electrolytic copper; gastight crimped; acc. to DIN 46228, Part 4/09.90; blue	<a href="http://www.wago.com/216-266">www.wago.com/216-266</a>

## tools

	<b>Item no.: 210-658</b> Operating tool; Blade: 3.5 x 0.5 mm; with a partially insulated shaft; angled; short	<a href="http://www.wago.com/210-658">www.wago.com/210-658</a>
	<b>Item no.: 210-720</b> Operating tool; Blade: 3.5 x 0.5 mm; with a partially insulated shaft	<a href="http://www.wago.com/210-720">www.wago.com/210-720</a>

## Test Accessories

	<b>Item no.: 2002-511</b> Modular TOPJOB®S connector; modular; for jumper contact slot; 1-pole; 2,50 mm <sup>2</sup> ; gray	<a href="http://www.wago.com/2002-511">www.wago.com/2002-511</a>
	<b>Item no.: 2002-549</b> Spacer module; modular; e.g., for bridging commoned terminal blocks; gray	<a href="http://www.wago.com/2002-549">www.wago.com/2002-549</a>
	<b>Item no.: 2002-552</b> Modular TOPJOB®S connector; modular; for jumper contact slot; 2-pole; 2,50 mm <sup>2</sup> ; gray	<a href="http://www.wago.com/2002-552">www.wago.com/2002-552</a>

Subject to changes. Please also observe the further product documentation!

WAGO Kontakttechnik GmbH &amp; Co. KG

Hansastr. 27











32423 Minden

Phone: +49571 887-0 | Fax: +49571 887-169

Email: [info.de@wago.com](mailto:info.de@wago.com) | Web: [www.wago.com](http://www.wago.com)

Do you have any questions about our products?

We are always happy to take your call at +49 (571) 887-44222.

	<b>Item no.: 2002-553</b> Modular TOPJOB®S connector; modular; for jumper contact slot; 3-pole; 2,50 mm²; gray	<a href="http://www.wago.com/2002-553">www.wago.com/2002-553</a>
	<b>Item no.: 2002-554</b> Modular TOPJOB®S connector; modular; for jumper contact slot; 4-pole; 2,50 mm²; gray	<a href="http://www.wago.com/2002-554">www.wago.com/2002-554</a>
	<b>Item no.: 2002-555</b> Modular TOPJOB®S connector; modular; for jumper contact slot; 5-pole; 2,50 mm²; gray	<a href="http://www.wago.com/2002-555">www.wago.com/2002-555</a>
	<b>Item no.: 2002-556</b> Modular TOPJOB®S connector; modular; for jumper contact slot; 6-pole; 2,50 mm²; gray	<a href="http://www.wago.com/2002-556">www.wago.com/2002-556</a>
	<b>Item no.: 2002-557</b> Modular TOPJOB®S connector; modular; for jumper contact slot; 7-pole; 2,50 mm²; gray	<a href="http://www.wago.com/2002-557">www.wago.com/2002-557</a>
	<b>Item no.: 2002-558</b> Modular TOPJOB®S connector; modular; for jumper contact slot; 8-pole; 2,50 mm²; gray	<a href="http://www.wago.com/2002-558">www.wago.com/2002-558</a>
	<b>Item no.: 2002-559</b> Modular TOPJOB®S connector; modular; for jumper contact slot; 9-pole; 2,50 mm²; gray	<a href="http://www.wago.com/2002-559">www.wago.com/2002-559</a>
	<b>Item no.: 2002-560</b> Modular TOPJOB®S connector; modular; for jumper contact slot; 10-pole; 2,50 mm²; gray	<a href="http://www.wago.com/2002-560">www.wago.com/2002-560</a>
	<b>Item no.: 2002-611</b> TOPJOB®S L-type test plug module; modular; 1-pole; 2,50 mm²; gray	<a href="http://www.wago.com/2002-611">www.wago.com/2002-611</a>
	<b>Item no.: 2002-649</b> TOPJOB®S L-type spacer module; modular; e.g., for bridging commoned terminal blocks; gray	<a href="http://www.wago.com/2002-649">www.wago.com/2002-649</a>
	<b>Item no.: 2009-174</b> Test plug adapter; for 4 mm Ø test plugs; for testing TOPJOB®S rail-mounted terminal blocks; gray	<a href="http://www.wago.com/2009-174">www.wago.com/2009-174</a>
	<b>Item no.: 2009-182</b> Testing tap; for max. 2.5 mm²; tool-free connection for individual test wires 0.08 - 2.5 mm; gray	<a href="http://www.wago.com/2009-182">www.wago.com/2009-182</a>
	<b>Item no.: 210-136</b> Test plug; 2 mm Ø; with 500 mm cable; red	<a href="http://www.wago.com/210-136">www.wago.com/210-136</a>
<b>Insulation stop</b>		
	<b>Item no.: 2002-171</b> Insulation stop; 0.25 - 0.5 mm²; 5 pieces/strip; light gray	<a href="http://www.wago.com/2002-171">www.wago.com/2002-171</a>
	<b>Item no.: 2002-172</b> Insulation stop; 0.75 - 1 mm²; 5 pieces/strip; dark gray	<a href="http://www.wago.com/2002-172">www.wago.com/2002-172</a>
<b>Push-In type wire jumper</b>		
	<b>Item no.: 2009-412</b> Push-in type wire jumper; insulated; wire length 60 mm; Conductor cross section 1.5 mm²; suitable for 2001, 2002, 2003 and 2022 Series rail-mounted terminal blocks; black	<a href="http://www.wago.com/2009-412">www.wago.com/2009-412</a>
	<b>Item no.: 2009-414</b> Push-in type wire jumper; insulated; wire length 110 mm; Conductor cross section 1.5 mm²; suitable for 2001, 2002, 2003 and 2022 Series rail-mounted terminal blocks; black	<a href="http://www.wago.com/2009-414">www.wago.com/2009-414</a>

Subject to changes. Please also observe the further product documentation!



Item no.: 2009-416

Push-in type wire jumper; insulated; wire length 250 mm; Conductor cross section 1.5 mm<sup>2</sup>; suitable for 2001, 2002, 2003 and 2022 Series rail-mounted terminal blocks; black

[www.wago.com/2009-416](http://www.wago.com/2009-416)

## Downloads

### Documentation

#### Additional Information

Technical explanations

Apr 3, 2019

pdf  
2.1 MB

Download

## Installation Notes

### Inserting a conductor

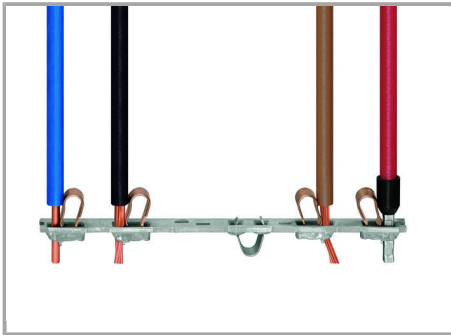

All conductor types at a glance

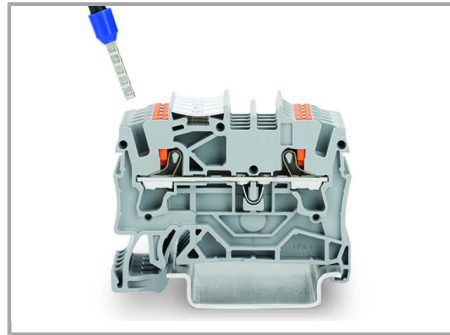

Push-in termination of solid and ferruled conductors



Insert fine-stranded conductors via operating tool.



Removing all conductors via operating tool.

### Jumpered

Subject to changes. Please also observe the further product documentation!

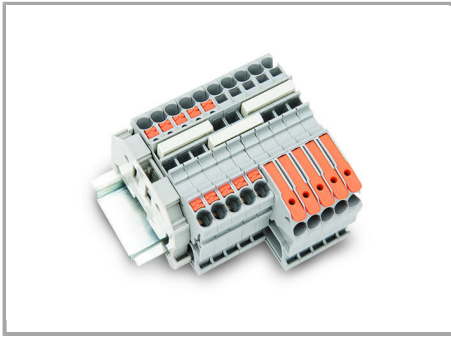

Insert push-in type jumper bar and push down until it hits backstop.

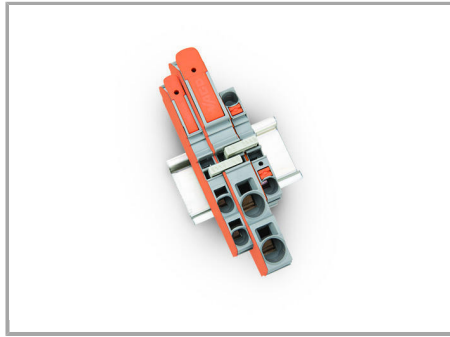

Commoning with step-down jumpers.

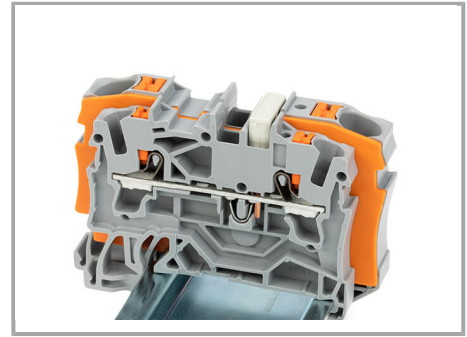

**Step-down jumper (2006-499)** commons 6 /4 mm<sup>2</sup> (10/12 AWG) terminal blocks (2206 /2204 Series) with 4/2.5/1.5 mm<sup>2</sup> (12/14/16 AWG) terminal blocks (2204/2202/2201 Series).

### Testing

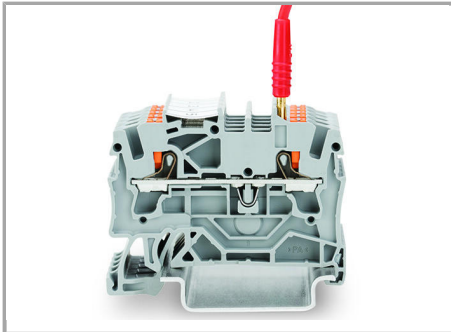

Testing with a 2 mm Ø test plug (max. 42 V).

### Marking

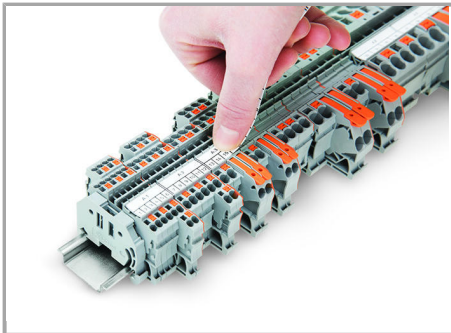

Snapping a marking strip into the marker slot.

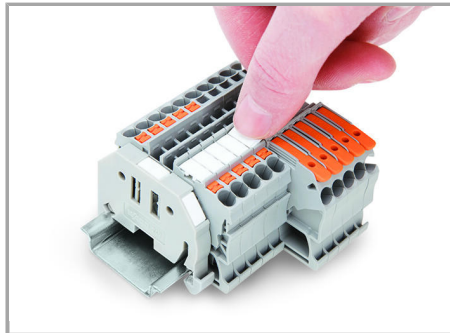

Snapping a marking strip into the marker slot.

### Product family

**TOPJOB® S**

Subject to changes. Please also observe the further product documentation!



TOPJOB® S: In various industrial applications and modern building installations, WAGO's wide and versatile range of rail-mount terminal blocks provides more than just reliable electrical connections.

[Learn more about the product family.](#)

[Show all products from the family](#)

Subject to changes. Please also observe the further product documentation!

---

WAGO Kontakttechnik GmbH & Co. KG  
Hansastr. 27  
32423 Minden  
Phone: +49571 887-0 | Fax: +49571 887-169  
Email: [info.de@wago.com](mailto:info.de@wago.com) | Web: [www.wago.com](http://www.wago.com)

Do you have any questions about our products?  
We are always happy to take your call at +49 (571) 887-44222.