

**Data sheet | Item number: 2201-1401**

4-conductor through terminal block; with push-button; 1.5 mm<sup>2</sup>; with test port; side and center marking; for DIN-rail 35 x 15 and 35 x 7.5; Push-in CAGE CLAMP®; 1,00 mm<sup>2</sup>; gray

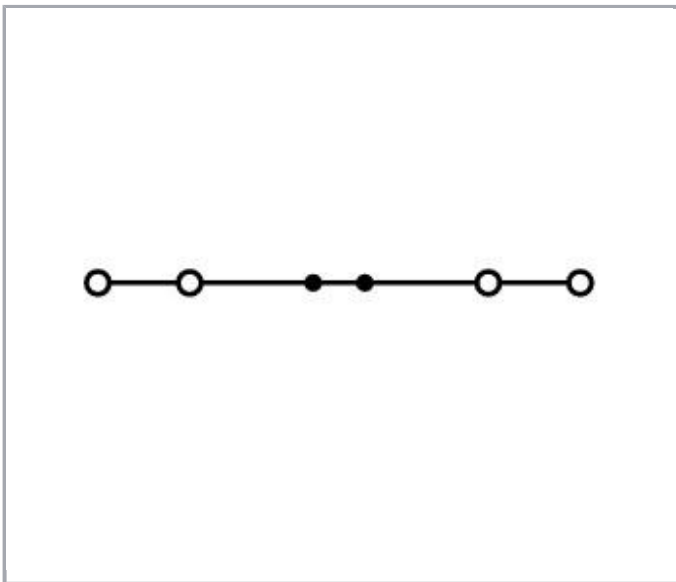

[www.wago.com/2201-1401](http://www.wago.com/2201-1401)

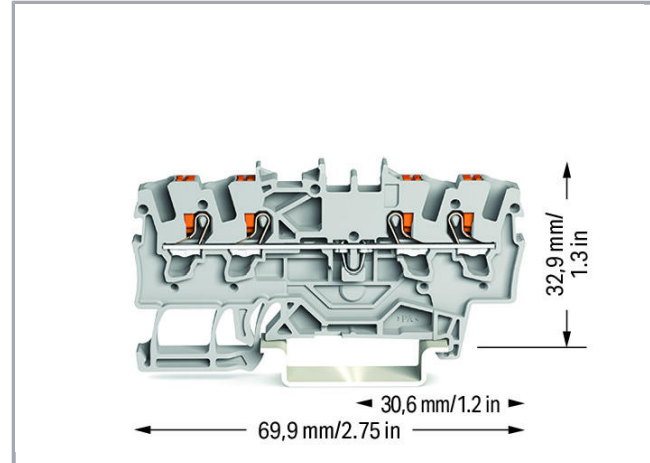
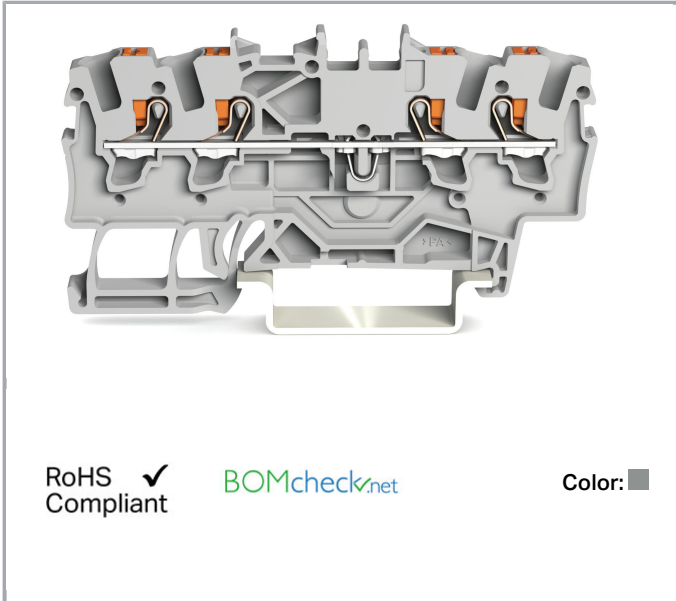

**Data**

**Electrical data**

Subject to changes. Please also observe the further product documentation!

WAGO Kontakttechnik GmbH & Co. KG  
Hansastr. 27  
32423 Minden  
Phone: +49571 887-0 | Fax: +49571 887-169  
Email: [info.de@wago.com](mailto:info.de@wago.com) | Web: [www.wago.com](http://www.wago.com)

Do you have any questions about our products?  
We are always happy to take your call at +49 (571) 887-44222.

## Ratings per IEC/EN 60664-1

Ratings per	IEC/EN 60947-7-1
Rated voltage (III / 3)	800 V
Rated impulse voltage (III / 3)	8 kV
Rated current	18 A
Rated current (2)	24 A
Legend (ratings)	(III / 3) $\hat{=}$ Overvoltage category III / Pollution degree 3

## Approvals per UL 1059

Rated voltage UL (Use Group B)	600 V
Rated current UL (Use Group B)	15 A
Rated voltage UL (Use Group C)	600 V
Rated current UL (Use Group C)	15 A
Approvals per	UL 1059

## Connection data

Connection technology	Push-in CAGE CLAMP®
Actuation type	Push-in Push-button
Connectable conductor materials	Copper
Nominal cross section	1,5 mm <sup>2</sup>
Solid conductor	0,25 ... 2,5 mm <sup>2</sup> / 22 ... 14 AWG
Solid conductor, push-in termination	0,75 ... 2,5 mm <sup>2</sup> / 18 ... 14 AWG
Fine-stranded conductor	0,25 ... 2,5 mm <sup>2</sup> / 22 ... 14 AWG
Fine-stranded conductor with ferrule with plastic collar	0,75 ... 1,5 mm <sup>2</sup> / 18 ... 16 AWG
Fine-stranded conductor with ferrule, push-in termination, from	0,75 ... 1,5 mm <sup>2</sup> / 18 ... 16 AWG
Strip length	9 ... 11 mm / 0.35 ... 0.43 inch
Total number of connection points	4
Total number of potentials	1
Number of levels	1
Type of wiring	Front-entry wiring
Note (conductor cross-section)	Depending on the conductor characteristic, a conductor with a smaller cross-section can also be inserted via push-in termination.
Number of jumper slots	2

Subject to changes. Please also observe the further product documentation!

## Geometrical Data

Width	4,2 mm / 0.165 inch
Height from upper-edge of DIN-35 rail	32,9 mm / 1.295 inch
Depth	69,9 mm / 2.752 inch

## Mechanical data

Design	horizontal type
Type of mounting	DIN-35 rail
Marking level	Center/side marking

## Material Data

Color	gray
Insulating material	Polyamide 66 (PA 66)
Weight	6.1 g

## Commercial data

Packaging type	BOX
Country of origin	DE
GTIN	4055143696852
Customs Tariff No.	85369010000



## Approvals / Certificates

### Ex-Approvals



Logo	Approval	Additional Approval Text	Certificate name
	ATEX Physikalisch Technische Bundesanstalt	IEC 60079-0	PTB 18 ATEX 1004 U (II 2 G Ex eb IIC Gb bzw. I M 2 Ex eb I Mb)
	IECEX Physikalisch Technische Bundesanstalt	IEC 60079-0	IECEX PTB 18.0011U (Ex eb IIC Gb and Ex eb I Mb)

Subject to changes. Please also observe the further product documentation!

## Country specific Approvals

Logo	Approval	Additional Approval Text	Certificate name
	<b>CCA</b> DEKRA Certification B.V.	EN 60947	NTR NL 7664
	<b>CSA</b> DEKRA Certification B.V.	C22.2	70173738
	<b>KEMA/KEUR</b> DEKRA Certification B.V.	EN 60947	71- 102875

## Ship Approvals

Logo	Approval	Additional Approval Text	Certificate name
	<b>ABS</b> American Bureau of Shipping	-	19- HG1866350- PDA
	<b>DNV GL</b> Det Norske Veritas, Germanischer Lloyd	-	TAE00003JT
	<b>LR</b> Lloyds Register	-	19/20050

## UL-Approvals

Logo	Approval	Additional Approval Text	Certificate name
	<b>cURus</b> Underwriters Laboratories Inc.	UL 1059	4788308064

## Counterpart

Subject to changes. Please also observe the further product documentation!

WAGO Kontakttechnik GmbH & Co. KG  
 Hansastr. 27  
 32423 Minden  
 Phone: +49571 887-0 | Fax: +49571 887-169  
 Email: [info.de@wago.com](mailto:info.de@wago.com) | Web: [www.wago.com](http://www.wago.com)

Do you have any questions about our products?  
 We are always happy to take your call at +49 (571) 887-44222.

## Compatible products

### Insulation stop

<b>Item no.: 2001-171</b> Insulation stop; 0.25 - 0.5 mm <sup>2</sup> ; 5 pieces/strip; light gray	<a href="http://www.wago.com/2001-171">www.wago.com/2001-171</a>
---	--

### Marking accessories

<b>Item no.: 2009-110</b> Marking strips; on reel; not stretchable; plain; snap-on type; white	<a href="http://www.wago.com/2009-110">www.wago.com/2009-110</a>
---	--

<b>Item no.: 2009-114</b> WMB-Inline; for Smart Printer; 2000 pieces on roll; stretchable 4 - 4.2 mm; plain; snap-on type; white	<a href="http://www.wago.com/2009-114">www.wago.com/2009-114</a>
---	--

<b>Item no.: 2009-114/000-002</b> WMB-Inline; for Smart Printer; 2000 pieces on roll; stretchable 4 - 4.2 mm; plain; snap-on type; yellow	<a href="http://www.wago.com/2009-114/000-002">www.wago.com/2009-114/000-002</a>
--	--

<b>Item no.: 2009-114/000-005</b> WMB-Inline; for Smart Printer; 2000 pieces on roll; stretchable 4 - 4.2 mm; plain; snap-on type; red	<a href="http://www.wago.com/2009-114/000-005">www.wago.com/2009-114/000-005</a>
---	--

<b>Item no.: 2009-114/000-006</b> WMB-Inline; for Smart Printer; 2000 pieces on roll; stretchable 4 - 4.2 mm; plain; snap-on type; blue	<a href="http://www.wago.com/2009-114/000-006">www.wago.com/2009-114/000-006</a>
--	--

<b>Item no.: 2009-114/000-007</b> WMB-Inline; for Smart Printer; 2000 pieces on roll; stretchable 4 - 4.2 mm; plain; snap-on type; gray	<a href="http://www.wago.com/2009-114/000-007">www.wago.com/2009-114/000-007</a>
--	--

 <b>Item no.: 2009-114/000-012</b> WMB-Inline; for Smart Printer; 2000 pieces on roll; stretchable 4 - 4.2 mm; plain; snap-on type; orange	<a href="http://www.wago.com/2009-114/000-012">www.wago.com/2009-114/000-012</a>
---	--

 <b>Item no.: 2009-114/000-023</b> WMB-Inline; for Smart Printer; 2000 pieces on roll; stretchable 4 - 4.2 mm; plain; snap-on type; green	<a href="http://www.wago.com/2009-114/000-023">www.wago.com/2009-114/000-023</a>
--	--

 <b>Item no.: 2009-114/000-024</b> WMB-Inline; for Smart Printer; 2000 pieces on roll; stretchable 4 - 4.2 mm; plain; snap-on type; violet	<a href="http://www.wago.com/2009-114/000-024">www.wago.com/2009-114/000-024</a>
---	--









Subject to changes. Please also observe the further product documentation!

<b>Item no.: 793-4501</b> WMB marking card; as card; stretchable 4 - 4.2 mm; plain; snap-on type; white	<a href="http://www.wago.com/793-4501">www.wago.com/793-4501</a>
<b>Item no.: 793-4501/000-002</b> WMB marking card; as card; stretchable 4 - 4.2 mm; plain; snap-on type; yellow	<a href="http://www.wago.com/793-4501/000-002">www.wago.com/793-4501/000-002</a>
<b>Item no.: 793-4501/000-005</b> WMB marking card; as card; stretchable 4 - 4.2 mm; plain; snap-on type; red	<a href="http://www.wago.com/793-4501/000-005">www.wago.com/793-4501/000-005</a>
<b>Item no.: 793-4501/000-006</b> WMB marking card; as card; stretchable 4 - 4.2 mm; plain; snap-on type; blue	<a href="http://www.wago.com/793-4501/000-006">www.wago.com/793-4501/000-006</a>
<b>Item no.: 793-4501/000-007</b> WMB marking card; as card; stretchable 4 - 4.2 mm; plain; snap-on type; gray	<a href="http://www.wago.com/793-4501/000-007">www.wago.com/793-4501/000-007</a>
<b>Item no.: 793-4501/000-012</b> WMB marking card; as card; stretchable 4 - 4.2 mm; plain; snap-on type; orange	<a href="http://www.wago.com/793-4501/000-012">www.wago.com/793-4501/000-012</a>
<b>Item no.: 793-4501/000-017</b> WMB marking card; as card; stretchable 4 - 4.2 mm; plain; snap-on type; green	<a href="http://www.wago.com/793-4501/000-017">www.wago.com/793-4501/000-017</a>
<b>Item no.: 793-4501/000-023</b> WMB marking card; as card; stretchable 4 - 4.2 mm; plain; snap-on type; light green	<a href="http://www.wago.com/793-4501/000-023">www.wago.com/793-4501/000-023</a>
<b>Item no.: 793-4501/000-024</b> WMB marking card; as card; stretchable 4 - 4.2 mm; plain; snap-on type; violet	<a href="http://www.wago.com/793-4501/000-024">www.wago.com/793-4501/000-024</a>

**Carrier rail**

<b>Item no.: 210-112</b> Steel carrier rail; 35 x 7.5 mm; 1 mm thick; 2 m long; slotted; according to EN 60715; "Hole width 25 mm	<a href="http://www.wago.com/210-112">www.wago.com/210-112</a>
<b>Item no.: 210-113</b> Steel carrier rail; 35 x 7.5 mm; 1 mm thick; 2 m long; unslotted; according to EN 60715	<a href="http://www.wago.com/210-113">www.wago.com/210-113</a>
<b>Item no.: 210-114</b> Steel carrier rail; 35 x 15 mm; 1.5 mm thick; 2 m long; unslotted; similar to EN 60715	<a href="http://www.wago.com/210-114">www.wago.com/210-114</a>
<b>Item no.: 210-115</b> Steel carrier rail; 35 x 7.5 mm; 1 mm thick; 2 m long; slotted; according to EN 60715; "Hole width 18 mm	<a href="http://www.wago.com/210-115">www.wago.com/210-115</a>
 <b>Item no.: 210-118</b> Steel carrier rail; 35 x 15 mm; 2.3 mm thick; 2 m long; unslotted; according to EN 60715	<a href="http://www.wago.com/210-118">www.wago.com/210-118</a>
<b>Item no.: 210-196</b>	

Subject to changes. Please also observe the further product documentation!

	Aluminum carrier rail; 35 x 8.2 mm; 1.6 mm thick; 2 m long; unslotted; similar to EN 60715; silver-colored	<a href="http://www.wago.com/210-196">www.wago.com/210-196</a>
	<b>Item no.: 210-197</b> Steel carrier rail; 35 x 15 mm; 1.5 mm thick; 2 m long; slotted; similar to EN 60715	<a href="http://www.wago.com/210-197">www.wago.com/210-197</a>
	<b>Item no.: 210-198</b> Copper carrier rail; 35 x 15 mm; 2.3 mm thick; 2 m long; unslotted; according to EN 60715; copper-colored	<a href="http://www.wago.com/210-198">www.wago.com/210-198</a>
<b>End plate</b>		
	<b>Item no.: 2002-1491</b> End and intermediate plate; 0.8 mm thick; gray	<a href="http://www.wago.com/2002-1491">www.wago.com/2002-1491</a>
	<b>Item no.: 2002-1492</b> End and intermediate plate; 0.8 mm thick; orange	<a href="http://www.wago.com/2002-1492">www.wago.com/2002-1492</a>
	<b>Item no.: 2002-1493</b> Separator plate; 2 mm thick; oversized; gray	<a href="http://www.wago.com/2002-1493">www.wago.com/2002-1493</a>
	<b>Item no.: 2002-1494</b> Separator plate; 2 mm thick; oversized; orange	<a href="http://www.wago.com/2002-1494">www.wago.com/2002-1494</a>
<b>Push-In type wire jumper</b>		
	<b>Item no.: 2009-412</b> Push-in type wire jumper; insulated; wire length 60 mm; Conductor cross section 1.5 mm <sup>2</sup> ; suitable for 2001, 2002, 2003 and 2022 Series rail-mounted terminal blocks; black	<a href="http://www.wago.com/2009-412">www.wago.com/2009-412</a>
	<b>Item no.: 2009-414</b> Push-in type wire jumper; insulated; wire length 110 mm; Conductor cross section 1.5 mm <sup>2</sup> ; suitable for 2001, 2002, 2003 and 2022 Series rail-mounted terminal blocks; black	<a href="http://www.wago.com/2009-414">www.wago.com/2009-414</a>
	<b>Item no.: 2009-414/000-005</b> Push-in type wire jumper; insulated; wire length 110 mm; Conductor cross section 1.5 mm <sup>2</sup> ; suitable for 2001, 2002, 2003 and 2022 Series rail-mounted terminal blocks; red	<a href="http://www.wago.com/2009-414/000-005">www.wago.com/2009-414/000-005</a>
	<b>Item no.: 2009-414/000-006</b> Push-in type wire jumper; insulated; wire length 110 mm; Conductor cross section 1.5 mm <sup>2</sup> ; suitable for 2001, 2002, 2003 and 2022 Series rail-mounted terminal blocks; blue	<a href="http://www.wago.com/2009-414/000-006">www.wago.com/2009-414/000-006</a>
	<b>Item no.: 2009-416</b> Push-in type wire jumper; insulated; wire length 250 mm; Conductor cross section 1.5 mm <sup>2</sup> ; suitable for 2001, 2002, 2003 and 2022 Series rail-mounted terminal blocks; black	<a href="http://www.wago.com/2009-416">www.wago.com/2009-416</a>
<b>ferrule</b>		
	<b>Item no.: 216-241</b> Ferrule; Sleeve for 0.5 mm <sup>2</sup> / 20 AWG; insulated; electro-tin plated; electrolytic copper; gastight crimped; acc. to DIN 46228, Part 4/09.90; white	<a href="http://www.wago.com/216-241">www.wago.com/216-241</a>
	<b>Item no.: 216-242</b> Ferrule; Sleeve for 0.75 mm <sup>2</sup> / 18 AWG; insulated; electro-tin plated; electrolytic copper; gastight crimped; acc. to DIN 46228, Part 4/09.90; gray	<a href="http://www.wago.com/216-242">www.wago.com/216-242</a>
	<b>Item no.: 216-243</b> Ferrule; Sleeve for 1 mm <sup>2</sup> / AWG 18; insulated; electro-tin plated; electrolytic copper; gastight crimped; acc. to DIN 46228, Part 4/09.90; red	<a href="http://www.wago.com/216-243">www.wago.com/216-243</a>

Subject to changes. Please also observe the further product documentation!

**Item no.: 216-244**

Ferrule; Sleeve for 1.5 mm<sup>2</sup> / AWG 16; insulated; electro-tin plated; electrolytic copper; gastight crimped; acc. to DIN 46228, Part 4/09.90; black

[www.wago.com/216-244](http://www.wago.com/216-244)**tools****Item no.: 210-647**

Operating tool; Blade: 2.5 x 0.4 mm; with a partially insulated shaft

[www.wago.com/210-647](http://www.wago.com/210-647)**Item no.: 210-648**

Operating tool; Blade: 2.5 x 0.4 mm; with a partially insulated shaft; angled; short

[www.wago.com/210-648](http://www.wago.com/210-648)**Item no.: 210-719**

Operating tool; Blade: 2.5 x 0.4 mm; with a partially insulated shaft

[www.wago.com/210-719](http://www.wago.com/210-719)**plug****Item no.: 2002-880**

Empty component plug housing; 10.4 mm wide; 2-pole; Type 4; gray

[www.wago.com/2002-880](http://www.wago.com/2002-880)**Item no.: 2002-880/1000-411**

Component plug; 2-pole; with diode 1N4007; 10.4 mm wide; Operating temperature 85°C max.; gray

[www.wago.com/2002-880/1000-411](http://www.wago.com/2002-880/1000-411)**Item no.: 2002-880/1000-541**

Component plug; 2-pole; LED (red); 10.4 mm wide; Operating temperature 85°C max.; gray

[www.wago.com/2002-880/1000-541](http://www.wago.com/2002-880/1000-541)**Item no.: 2002-880/1000-542**

LED module; with red LED; 10.4 mm wide; 30 - 65 V; Operating temperature 85°C max.

[www.wago.com/2002-880/1000-542](http://www.wago.com/2002-880/1000-542)**Item no.: 2002-880/1000-836**

Component plug; 2-pole; LED (red); 10.4 mm wide; Operating temperature 85°C max.; gray

[www.wago.com/2002-880/1000-836](http://www.wago.com/2002-880/1000-836)**Jumper****Item no.: 2001-402**

Push-in type jumper bar; insulated; 2-way; Nominal current 18 A; light gray

[www.wago.com/2001-402](http://www.wago.com/2001-402)**Item no.: 2001-403**

Push-in type jumper bar; insulated; 3-way; Nominal current 18 A; light gray

[www.wago.com/2001-403](http://www.wago.com/2001-403)**Item no.: 2001-404**

Push-in type jumper bar; insulated; 4-way; Nominal current 18 A; light gray

[www.wago.com/2001-404](http://www.wago.com/2001-404)**Item no.: 2001-405**

Push-in type jumper bar; insulated; 5-way; Nominal current 18 A; light gray

[www.wago.com/2001-405](http://www.wago.com/2001-405)**Item no.: 2001-405/011-000**

Star point jumper; insulated; 3-way (1-3-5); IN = IN terminal block; light gray

[www.wago.com/2001-405/011-000](http://www.wago.com/2001-405/011-000)**Item no.: 2001-406**

Push-in type jumper bar; insulated; 6-way; Nominal current 18 A; light gray

[www.wago.com/2001-406](http://www.wago.com/2001-406)

Subject to changes. Please also observe the further product documentation!

WAGO Kontakttechnik GmbH & Co. KG

Hansastr. 27

32423 Minden

Phone: +49571 887-0 | Fax: +49571 887-169

Email: [info.de@wago.com](mailto:info.de@wago.com) | Web: [www.wago.com](http://www.wago.com)

Do you have any questions about our products?

We are always happy to take your call at +49 (571) 887-44222.

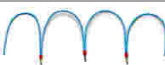

<b>Item no.: 2001-406/020-000</b> Delta jumper; insulated; 1-2 3-4 5-6; IN = IN terminal block; light gray	<a href="http://www.wago.com/2001-406/020-000">www.wago.com/2001-406/020-000</a>
<b>Item no.: 2001-407</b> Push-in type jumper bar; insulated; 7-way; Nominal current 18 A; light gray	<a href="http://www.wago.com/2001-407">www.wago.com/2001-407</a>
<b>Item no.: 2001-408</b> Push-in type jumper bar; insulated; 8-way; Nominal current 18 A; light gray	<a href="http://www.wago.com/2001-408">www.wago.com/2001-408</a>
<b>Item no.: 2001-409</b> Push-in type jumper bar; insulated; 9-way; Nominal current 18 A; light gray	<a href="http://www.wago.com/2001-409">www.wago.com/2001-409</a>
<b>Item no.: 2001-410</b> Push-in type jumper bar; insulated; 10-way; Nominal current 18 A; light gray	<a href="http://www.wago.com/2001-410">www.wago.com/2001-410</a>
<b>Item no.: 2001-433</b> Push-in type jumper bar; insulated; from 1 to 3; Nominal current 18 A; light gray	<a href="http://www.wago.com/2001-433">www.wago.com/2001-433</a>
<b>Item no.: 2001-434</b> Push-in type jumper bar; insulated; from 1 to 4; Nominal current 18 A; light gray	<a href="http://www.wago.com/2001-434">www.wago.com/2001-434</a>
<b>Item no.: 2001-435</b> Push-in type jumper bar; insulated; from 1 to 5; Nominal current 18 A; light gray	<a href="http://www.wago.com/2001-435">www.wago.com/2001-435</a>
<b>Item no.: 2001-436</b> Push-in type jumper bar; insulated; from 1 to 6; Nominal current 18 A; light gray	<a href="http://www.wago.com/2001-436">www.wago.com/2001-436</a>
<b>Item no.: 2001-437</b> Push-in type jumper bar; insulated; from 1 to 7; Nominal current 18 A; light gray	<a href="http://www.wago.com/2001-437">www.wago.com/2001-437</a>
<b>Item no.: 2001-438</b> Push-in type jumper bar; insulated; from 1 to 8; Nominal current 18 A; light gray	<a href="http://www.wago.com/2001-438">www.wago.com/2001-438</a>
<b>Item no.: 2001-439</b> Push-in type jumper bar; insulated; from 1 to 9; Nominal current 18 A; light gray	<a href="http://www.wago.com/2001-439">www.wago.com/2001-439</a>
<b>Item no.: 2001-440</b> Push-in type jumper bar; insulated; from 1 to 10; Nominal current 18 A; light gray	<a href="http://www.wago.com/2001-440">www.wago.com/2001-440</a>
<b>Item no.: 2006-499</b> Step-down jumper; insulated; from 6/4 mm <sup>2</sup> to 4/2.5/1.5 mm <sup>2</sup> ; Nominal current 32 A; light gray	<a href="http://www.wago.com/2006-499">www.wago.com/2006-499</a>
 <b>Item no.: 210-103</b> Wire commoning chain; insulated; 50 connections; black	<a href="http://www.wago.com/210-103">www.wago.com/210-103</a>
 <b>Item no.: 210-123</b> Wire commoning chain; insulated; 50 connections	<a href="http://www.wago.com/210-123">www.wago.com/210-123</a>
<b>Test Accessories</b>	
<b>Item no.: 2001-511</b> Modular TOPJOB®S connector; modular; for jumper contact slot; 1-pole; 1,50 mm <sup>2</sup> ; gray	<a href="http://www.wago.com/2001-511">www.wago.com/2001-511</a>
<b>Item no.: 2001-549</b>	

Subject to changes. Please also observe the further product documentation!

Spacer module; modular; e.g., for bridging commoned terminal blocks; gray

[www.wago.com/2001-549](http://www.wago.com/2001-549)

**Item no.: 2001-552**

Modular TOPJOB®S connector; modular; for jumper contact slot; 2-pole; 1,50 mm<sup>2</sup>; gray

[www.wago.com/2001-552](http://www.wago.com/2001-552)

**Item no.: 2001-553**

Modular TOPJOB®S connector; modular; for jumper contact slot; 3-pole; 1,50 mm<sup>2</sup>; gray

[www.wago.com/2001-553](http://www.wago.com/2001-553)

**Item no.: 2001-554**

Modular TOPJOB®S connector; modular; for jumper contact slot; 4-pole; 1,50 mm<sup>2</sup>; gray

[www.wago.com/2001-554](http://www.wago.com/2001-554)

**Item no.: 2001-555**

Modular TOPJOB®S connector; modular; for jumper contact slot; 5-pole; 1,50 mm<sup>2</sup>; gray

[www.wago.com/2001-555](http://www.wago.com/2001-555)

**Item no.: 2001-556**

Modular TOPJOB®S connector; modular; for jumper contact slot; 6-pole; 1,50 mm<sup>2</sup>; gray

[www.wago.com/2001-556](http://www.wago.com/2001-556)

**Item no.: 2001-557**

Modular TOPJOB®S connector; modular; for jumper contact slot; 7-pole; 1,50 mm<sup>2</sup>; gray

[www.wago.com/2001-557](http://www.wago.com/2001-557)

**Item no.: 2001-558**

Modular TOPJOB®S connector; modular; for jumper contact slot; 8-pole; 1,50 mm<sup>2</sup>; gray

[www.wago.com/2001-558](http://www.wago.com/2001-558)

**Item no.: 2001-559**

Modular TOPJOB®S connector; modular; for jumper contact slot; 9-pole; 1,50 mm<sup>2</sup>; gray

[www.wago.com/2001-559](http://www.wago.com/2001-559)

**Item no.: 2001-560**

Modular TOPJOB®S connector; modular; for jumper contact slot; 10-pole; 1,50 mm<sup>2</sup>; gray

[www.wago.com/2001-560](http://www.wago.com/2001-560)



**Item no.: 2009-174**

Test plug adapter; for 4 mm Ø test plugs; for testing TOPJOB®S rail-mounted terminal blocks; gray

[www.wago.com/2009-174](http://www.wago.com/2009-174)



**Item no.: 2009-182**

Testing tap; for max. 2.5 mm<sup>2</sup>; tool-free connection for individual test wires 0.08 - 2.5 mm; gray

[www.wago.com/2009-182](http://www.wago.com/2009-182)

## Downloads

### Documentation

#### Additional Information

Technical explanations

Apr 3, 2019

pdf  
2.1 MB

Download

## CAD/CAE-Data

### CAD data

2D/3D Models 2201-1401

URL

Download

### CAE data

Subject to changes. Please also observe the further product documentation!

WAGO Kontakttechnik GmbH & Co. KG

Hansastr. 27

32423 Minden

Phone: +49571 887-0 | Fax: +49571 887-169

Email: [info.de@wago.com](mailto:info.de@wago.com) | Web: [www.wago.com](http://www.wago.com)

Do you have any questions about our products?

We are always happy to take your call at +49 (571) 887-44222.

## Installation Notes

### Inserting a conductor

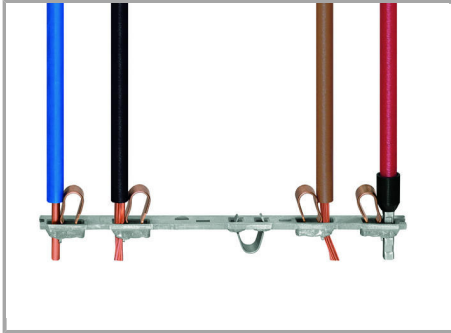

All conductor types at a glance

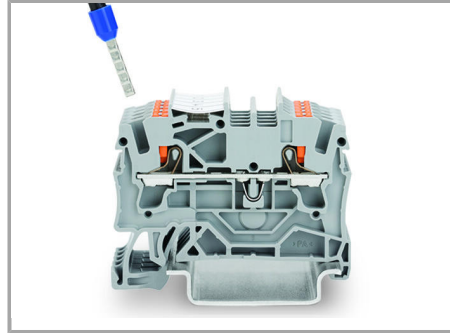

Push-in termination of solid and ferruled conductors



Insert fine-stranded conductors via operating tool.



Removing all conductors via operating tool.

### Jumpered

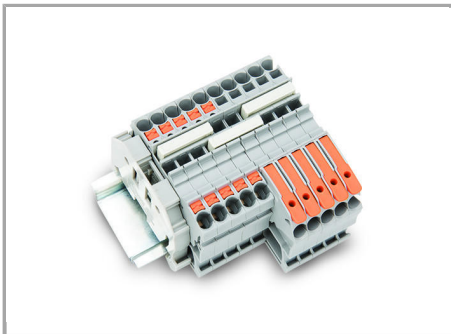

Insert push-in type jumper bar and push down until it hits backstop.

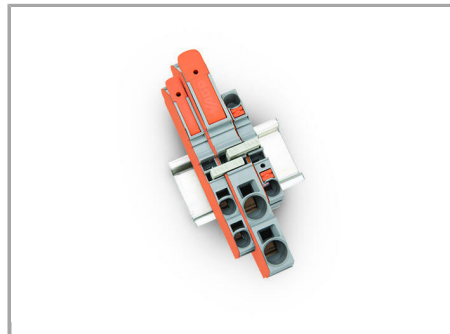

Commoning with step-down jumpers.

Subject to changes. Please also observe the further product documentation!

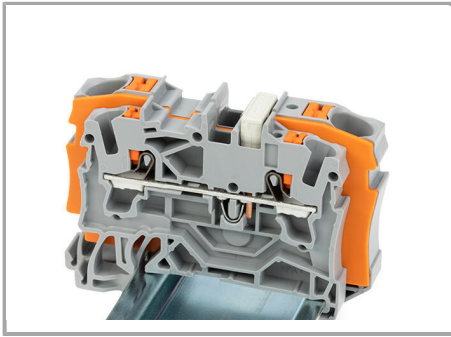

**Step-down jumper (2006-499)** connects 6 /4 mm<sup>2</sup> (10/12 AWG) terminal blocks (2206 /2204 Series) with 4/2.5/1.5 mm<sup>2</sup> (12/14/16 AWG) terminal blocks (2204/2202/2201 Series).

#### Testing

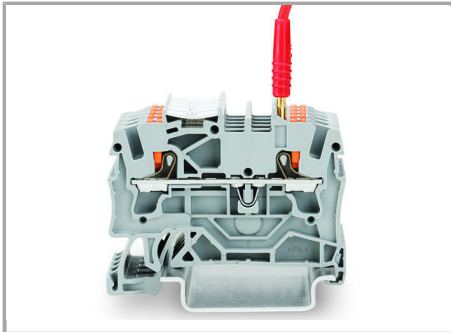

Testing with a 2 mm Ø test plug (max. 42 V).

#### Marking

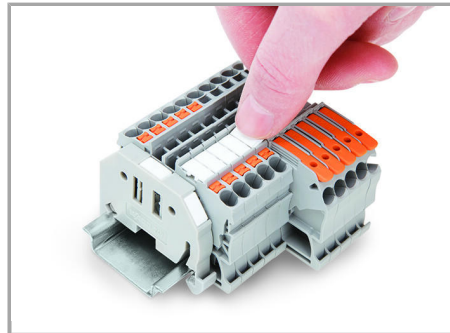
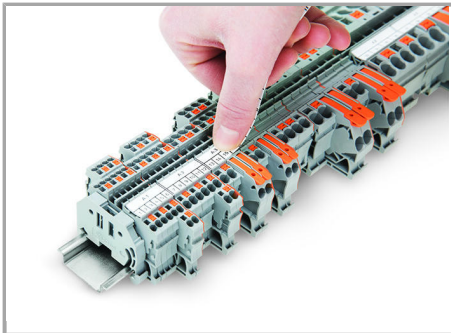

Snapping a marking strip into the marker slot. Snapping a marking strip into the marker slot.

#### Product family

**TOPJOB® S**

Subject to changes. Please also observe the further product documentation!



TOPJOB® S: In various industrial applications and modern building installations, WAGO's wide and versatile range of rail-mount terminal blocks provides more than just reliable electrical connections.

[Learn more about the product family.](#)

[Show all products from the family](#)

Subject to changes. Please also observe the further product documentation!

---

WAGO Kontakttechnik GmbH & Co. KG  
Hansastr. 27  
32423 Minden  
Phone: +49571 887-0 | Fax: +49571 887-169  
Email: [info.de@wago.com](mailto:info.de@wago.com) | Web: [www.wago.com](http://www.wago.com)

Do you have any questions about our products?  
We are always happy to take your call at +49 (571) 887-44222.