

**Data sheet | Item number: 218-509**

PCB terminal block; Locking slides; 0.5 mm<sup>2</sup>; Pin spacing 2.54 mm; 9-pole;  
CAGE CLAMP®; 0,50 mm<sup>2</sup>; gray



[www.wago.com/218-509](http://www.wago.com/218-509)



RoHS  Compliant

BOMcheck.net

Color:

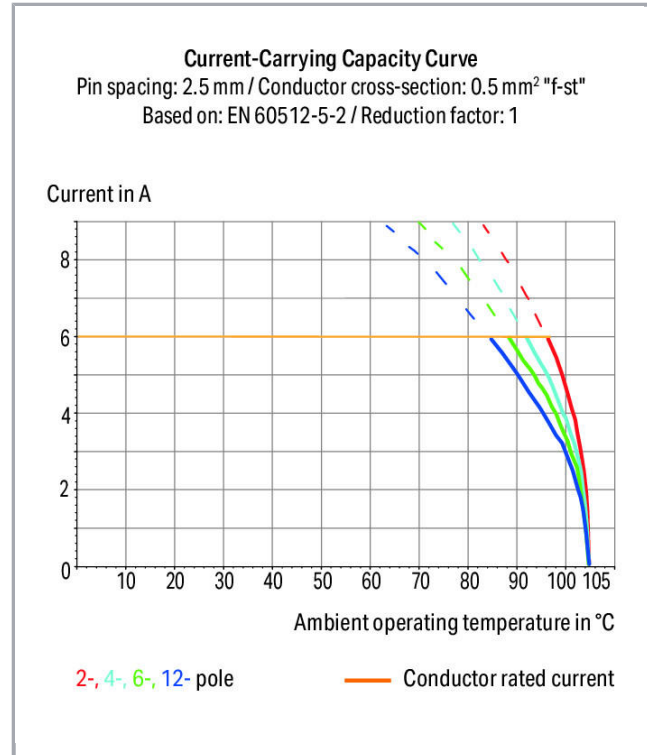

Subject to changes. Please also observe the further product documentation!

WAGO Kontakttechnik GmbH & Co. KG  
Hansastr. 27  
32423 Minden  
Phone: +49571 887-0 | Fax: +49571 887-169  
Email: [info.de@wago.com](mailto:info.de@wago.com) | Web: [www.wago.com](http://www.wago.com)

Do you have any questions about our products?  
We are always happy to take your call at +49 (571) 887-44222.



### Item description

- Terminal strips are just 8.1 mm tall and feature an innovative, locking slide-actuated CAGE CLAMP®
- Several clamping units can be held open simultaneously
- Easily terminate stranded conductors in

tight spaces (e.g., bus connectors)

### Data

#### Electrical data

#### Ratings per IEC/EN 60664-1

Ratings per	IEC/EN 60664-1
Rated voltage (III / 3)	80 V
Rated impulse voltage (III / 3)	2.5 kV
Rated voltage (III / 2)	160 V
Rated impulse voltage (III / 2)	2.5 kV

Subject to changes. Please also observe the further product documentation!

WAGO Kontakttechnik GmbH & Co. KG  
 Hansastr. 27  
 32423 Minden  
 Phone: +49571 887-0 | Fax: +49571 887-169  
 Email: [info.de@wago.com](mailto:info.de@wago.com) | Web: [www.wago.com](http://www.wago.com)

Do you have any questions about our products?  
 We are always happy to take your call at +49 (571) 887-44222.



Rated voltage (II / 2)	320 V
Rated impulse voltage (II / 2)	2.5 kV
Rated current	6 A
Legend (ratings)	(III / 2) ≙ Overvoltage category III / Pollution degree 2

### Approvals per UL 1059

Rated voltage UL (Use Group B)	150 V
Rated current UL (Use Group B)	4 A
Approvals per	UL 1059

### Approvals per CSA

Rated voltage CSA (Use Group B)	150 V
Rated current CSA (Use Group B)	4 A

### Connection data

Connection technology	CAGE CLAMP®
Actuation type	Slider
Solid conductor	0,08 ... 0,5 mm <sup>2</sup> / 28 ... 20 AWG
Fine-stranded conductor	0,08 ... 0,5 mm <sup>2</sup> / 28 ... 20 AWG
Fine-stranded conductor with ferrule with plastic collar	0,25 mm <sup>2</sup>
Fine-stranded conductor with ferrule without plastic collar	0,25 mm <sup>2</sup>
Strip length	5 ... 6 mm / 0.2 ... 0.24 inch
Conductor entry angle to the PCB	40°
No. of poles	9
Total number of connection points	9
Total number of potentials	9
Number of connection types	1
Number of levels	1
Note (conductor cross-section)	Terminating 0.75 mm <sup>2</sup> /18 AWG conductors is possible; however insulation diameter allows only every other clamping unit to be terminated with this conductor size.

### Geometrical Data

Pin spacing	2,54 mm / 0.1 inch
Width	24,36 mm / 0.959 inch
Height	10,9 mm / 0.429 inch

Subject to changes. Please also observe the further product documentation!

WAGO Kontakttechnik GmbH & Co. KG  
 Hansastr. 27  
 32423 Minden  
 Phone: +49571 887-0 | Fax: +49571 887-169  
 Email: [info.de@wago.com](mailto:info.de@wago.com) | Web: [www.wago.com](http://www.wago.com)

Do you have any questions about our products?  
 We are always happy to take your call at +49 (571) 887-44222.



Height from the surface	8,1 mm / 0.319 inch
Depth	13 mm / 0.512 inch
Solder pin length	2.8 mm
Solder pin dimensions	0,5 x 0,75 mm
Drilled hole diameter (tolerance)	1,1 <sup>(+0,1)</sup> mm

### PCB contact

PCB contact	THT
Solder pin arrangement	over the entire terminal strip (in-line)
Number of solder pins per potential	2

### Material Data

Color	gray
Material group	I
Insulating material	Polyamide 66 (PA 66)
Flammability class per UL94	V0
Clamping spring material	Chrome nickel spring steel (CrNi)
Contact material	Electrolytic copper (E <sub>Cu</sub> )
Contact plating	tin-plated
Fire load	0.039 MJ
Weight	3 g

### Environmental Requirements

Limit temperature range	-60 ... +105 °C
-------------------------	-----------------

### Commercial data

Product Group	4 (Printed Circuit)
Packaging type	BOX
Country of origin	PL
GTIN	4044918878456
Customs Tariff No.	85369010000

### Approvals / Certificates





#### Country specific Approvals

Logo	Approval	Additional Approval Text	Certificate name

Subject to changes. Please also observe the further product documentation!

WAGO Kontakttechnik GmbH & Co. KG  
 Hansastr. 27  
 32423 Minden  
 Phone: +49571 887-0 | Fax: +49571 887-169  
 Email: [info.de@wago.com](mailto:info.de@wago.com) | Web: [www.wago.com](http://www.wago.com)

Do you have any questions about our products?  
 We are always happy to take your call at +49 (571) 887-44222.

	CCA DEKRA Certification B.V.	EN 60947	NTR NL-7076
	CCA DEKRA Certification B.V.	EN 60947-7-4	NTR NL-7267
	CSA DEKRA Certification B.V.	C22.2 No. 158	1565656
	ENEC DEKRA Certification B.V.	EN 60947	2160584.01

UL-Approvals

Logo	Approval	Additional Approval Text	Certificate name
	UL UL International Germany GmbH	UL 1059	20190630-E45172

Counterpart

Compatible products

ferrule		
	<b>Item no.: 216-131</b> Ferrule; Sleeve for 0.25 mm <sup>2</sup> / AWG 24; uninsulated; electro-tin plated	<a href="http://www.wago.com/216-131">www.wago.com/216-131</a>
	<b>Item no.: 216-151</b> Ferrule; Sleeve for 0.25 mm <sup>2</sup> / AWG 24; uninsulated; electro-tin plated	<a href="http://www.wago.com/216-151">www.wago.com/216-151</a>
	<b>Item no.: 216-301</b> Ferrule; Sleeve for 0.25 mm <sup>2</sup> / AWG 24; insulated; electro-tin plated; yellow	<a href="http://www.wago.com/216-301">www.wago.com/216-301</a>
	<b>Item no.: 216-321</b> Ferrule; Sleeve for 0.25 mm <sup>2</sup> / AWG 24; insulated; electro-tin plated; yellow	<a href="http://www.wago.com/216-321">www.wago.com/216-321</a>

Subject to changes. Please also observe the further product documentation!

### Test Accessories

<b>Item no.: 735-500</b> Test pin; 1 mm Ø; with solder connection for test wire	<a href="http://www.wago.com/735-500">www.wago.com/735-500</a>
--	--

### tools

<b>Item no.: 210-648</b> Operating tool; Blade: 2.5 x 0.4 mm; with a partially insulated shaft; angled; short	<a href="http://www.wago.com/210-648">www.wago.com/210-648</a>
--	--



<b>Item no.: 210-719</b> Operating tool; Blade: 2.5 x 0.4 mm; with a partially insulated shaft	<a href="http://www.wago.com/210-719">www.wago.com/210-719</a>
---	--

### Marking accessories

<b>Item no.: 210-331/254-202</b> Marking strips; as a DIN A4 sheet; MARKED; 1-16 (400x); Height of marker strip: 2.3 mm/0.091 in; Strip length 182 mm; Horizontal marking; Self-adhesive; white	<a href="http://www.wago.com/210-331/254-202">www.wago.com/210-331/254-202</a>
--	--

<b>Item no.: 210-331/254-204</b> Marking strips; as a DIN A4 sheet; MARKED; 17-32 (400x); Height of marker strip: 2.3 mm/0.091 in; Strip length 182 mm; Horizontal marking; Self-adhesive; white	<a href="http://www.wago.com/210-331/254-204">www.wago.com/210-331/254-204</a>
---	--

<b>Item no.: 210-331/254-206</b> Marking strips; as a DIN A4 sheet; MARKED; 33-48 (400x); Height of marker strip: 2.3 mm/0.091 in; Strip length 182 mm; Horizontal marking; Self-adhesive; white	<a href="http://www.wago.com/210-331/254-206">www.wago.com/210-331/254-206</a>
---	--

<b>Item no.: 210-331/254-207</b> Marking strips; as a DIN A4 sheet; MARKED; 1-48 (100x); Height of marker strip: 2.3 mm/0.091 in; Strip length 182 mm; Horizontal marking; Self-adhesive; white	<a href="http://www.wago.com/210-331/254-207">www.wago.com/210-331/254-207</a>
--	--

## Downloads

### Documentation

#### Additional Information

Technical explanations	Apr 3, 2019	pdf 3.6 MB	Download
------------------------	-------------	---------------	----------

### CAD/CAE-Data

#### CAD data

2D/3D Models 218-509	URL	Download
----------------------	-----	----------

#### CAE data

EPLAN Data Portal 218-509	URL	Download
---------------------------	-----	----------

### PCB Design

Symbol and Footprint 218-509

Subject to changes. Please also observe the further product documentation!

WAGO Kontakttechnik GmbH & Co. KG  
Hansastr. 27  
32423 Minden  
Phone: +49571 887-0 | Fax: +49571 887-169  
Email: [info.de@wago.com](mailto:info.de@wago.com) | Web: [www.wago.com](http://www.wago.com)

Do you have any questions about our products?  
We are always happy to take your call at +49 (571) 887-44222.



[URL](#)

[Download](#)

CAX data for your PCB design, consisting of "schematic symbols and PCB footprints", allow easy integration of the WAGO component into your development environment.

#### Supported formats:

- Accel EDA 14 & 15
- Altium 6 to current version
- Cadence Allegro
- DesignSpark
- Eagle Libraries
- KiCad
- Mentor Graphics BoardStation
- Mentor Graphics Design Architect
- Mentor Graphics Design Expedition 99 and 2000
- OrCAD 9.X PCB and Capture
- PADS PowerPCB 3, 3.5, 4.X, and 5.X
- PADS PowerPCB and PowerLogic 3.0
- PCAD 2000, 2001, 2002, 2004, and 2006
- Pulsonix 8.5 or newer
- STL
- 3D STEP
- TARGET 3001!
- View Logic ViewDraw
- Quadcept
- Zuken CadStar 3 and 4
- Zuken CR-5000 and CR-8000

PCB Component Libraries (EDA), PCB CAD Library Ultra Librarian

---

## Installation Notes

### Conductor termination

Subject to changes. Please also observe the further product documentation!

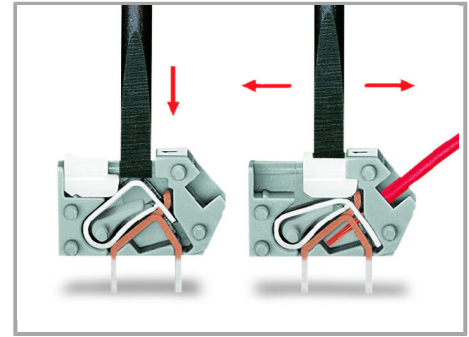
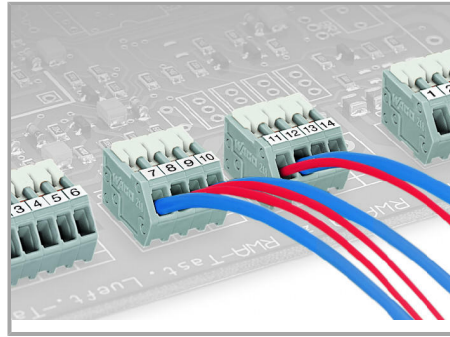

Terminating stranded conductors in confined spaces requires a great deal of patience, unless you use the new 218 Series PCB Terminal Strips. The clamping units of these strips can be held open during termination process via integrated locking slide.

Terminating 0.75 mm<sup>2</sup> (18 AWG) conductors is possible; however, insulation diameter allows only every other clamping unit to be terminated with this conductor size.

Conductor termination: To momentarily open the clamping unit, use screwdriver and then insert a stripped conductor. To open clamping unit for an extended period, move locking slide toward conductor entry hole. Then fully insert stripped conductor and move locking slide back to original position (also possible to perform with fingernail).

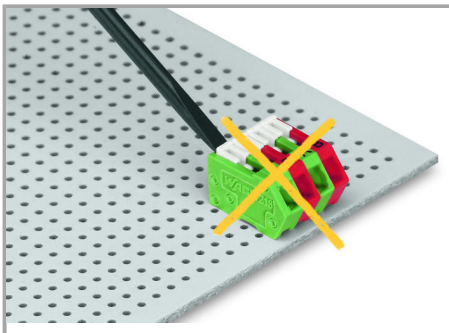

Incorrect – do not operate the locking slides from the back.

## Marking

Subject to changes. Please also observe the further product documentation!





Labeling with self-adhesive marking strips.



Labeling via factory direct marking.

### Testing



Testing directly on the clamping spring.

Subject to changes. Please also observe the further product documentation!