

Data sheet | Item number: 218-506

PCB terminal block; Locking slides; 0.5 mm²; Pin spacing 2.54 mm; 6-pole;
CAGE CLAMP®; 0,50 mm²; gray



www.wago.com/218-506



RoHS Compliant

BOMcheck.net

Color: ■

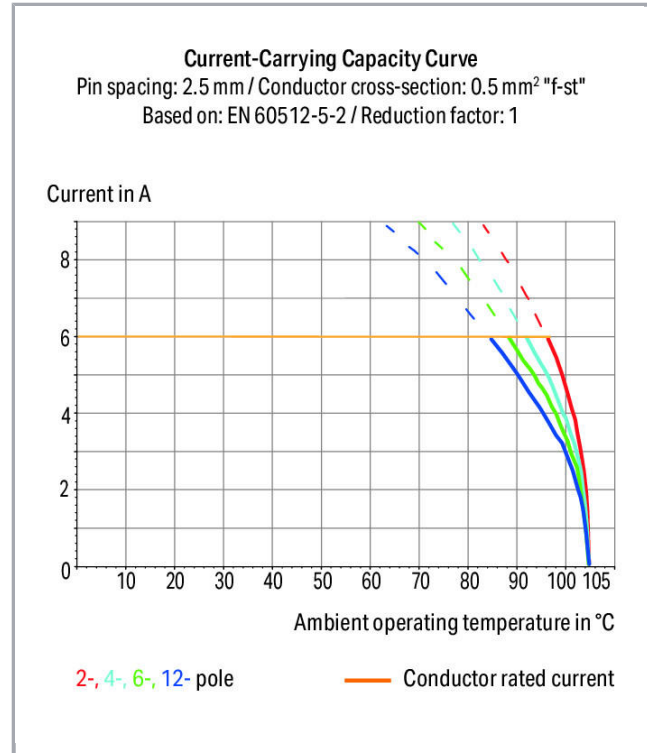

Subject to changes. Please also observe the further product documentation!

WAGO Kontakttechnik GmbH & Co. KG
Hansastr. 27
32423 Minden
Phone: +49571 887-0 | Fax: +49571 887-169
Email: info.de@wago.com | Web: www.wago.com

Do you have any questions about our products?
We are always happy to take your call at +49 (571) 887-44222.

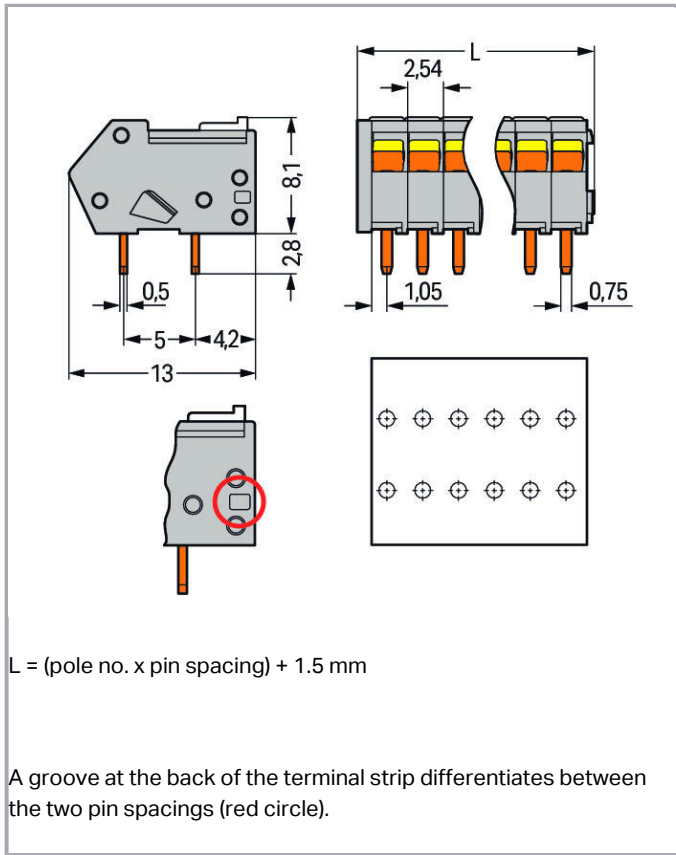

Item description

- Terminal strips are just 8.1 mm tall and feature an innovative, locking slide-actuated CAGE CLAMP®
- Several clamping units can be held open simultaneously
- Easily terminate stranded conductors in

tight spaces (e.g., bus connectors)

Data

Electrical data

Ratings per IEC/EN 60664-1

| Ratings per | IEC/EN 60664-1 |
|---------------------------------|----------------|
| Rated voltage (III / 3) | 80 V |
| Rated impulse voltage (III / 3) | 2.5 kV |
| Rated voltage (III / 2) | 160 V |
| Rated impulse voltage (III / 2) | 2.5 kV |

Subject to changes. Please also observe the further product documentation!

WAGO Kontakttechnik GmbH & Co. KG
 Hansastr. 27
 32423 Minden
 Phone: +49571 887-0 | Fax: +49571 887-169
 Email: info.de@wago.com | Web: www.wago.com

Do you have any questions about our products?
 We are always happy to take your call at +49 (571) 887-44222.



| | |
|--------------------------------|---|
| Rated voltage (II / 2) | 320 V |
| Rated impulse voltage (II / 2) | 2.5 kV |
| Rated current | 6 A |
| Legend (ratings) | (III / 2) ≙ Overvoltage category III / Pollution degree 2 |

Approvals per UL 1059

| | |
|--------------------------------|---------|
| Rated voltage UL (Use Group B) | 150 V |
| Rated current UL (Use Group B) | 4 A |
| Approvals per | UL 1059 |

Approvals per CSA

| | |
|---------------------------------|-------|
| Rated voltage CSA (Use Group B) | 150 V |
| Rated current CSA (Use Group B) | 4 A |

Connection data

| | |
|---|---|
| Connection technology | CAGE CLAMP® |
| Actuation type | Slider |
| Solid conductor | 0,08 ... 0,5 mm ² / 28 ... 20 AWG |
| Fine-stranded conductor | 0,08 ... 0,5 mm ² / 28 ... 20 AWG |
| Fine-stranded conductor with ferrule with plastic collar | 0,25 mm ² |
| Fine-stranded conductor with ferrule without plastic collar | 0,25 mm ² |
| Strip length | 5 ... 6 mm / 0.2 ... 0.24 inch |
| Conductor entry angle to the PCB | 40° |
| No. of poles | 6 |
| Total number of connection points | 6 |
| Total number of potentials | 6 |
| Number of connection types | 1 |
| Number of levels | 1 |
| Note (conductor cross-section) | Terminating 0.75 mm ² /18 AWG conductors is possible; however insulation diameter allows only every other clamping unit to be terminated with this conductor size. |

Geometrical Data

| | |
|-------------|-----------------------|
| Pin spacing | 2,54 mm / 0.1 inch |
| Width | 16,74 mm / 0.659 inch |
| Height | 10,9 mm / 0.429 inch |

Subject to changes. Please also observe the further product documentation!

WAGO Kontakttechnik GmbH & Co. KG
 Hansastr. 27
 32423 Minden
 Phone: +49571 887-0 | Fax: +49571 887-169
 Email: info.de@wago.com | Web: www.wago.com

Do you have any questions about our products?
 We are always happy to take your call at +49 (571) 887-44222.



| | |
|-----------------------------------|--------------------------|
| Height from the surface | 8,1 mm / 0.319 inch |
| Depth | 13 mm / 0.512 inch |
| Solder pin length | 2.8 mm |
| Solder pin dimensions | 0,5 x 0,75 mm |
| Drilled hole diameter (tolerance) | 1,1 ^(+0,1) mm |

PCB contact

| | |
|-------------------------------------|--|
| PCB contact | THT |
| Solder pin arrangement | over the entire terminal strip (in-line) |
| Number of solder pins per potential | 2 |

Material Data

| | |
|-----------------------------|--|
| Color | gray |
| Material group | I |
| Insulating material | Polyamide 66 (PA 66) |
| Flammability class per UL94 | V0 |
| Clamping spring material | Chrome nickel spring steel (CrNi) |
| Contact material | Electrolytic copper (E _{Cu}) |
| Contact plating | tin-plated |
| Fire load | 0.027 MJ |
| Weight | 2 g |

Environmental Requirements

| | |
|-------------------------|-----------------|
| Limit temperature range | -60 ... +105 °C |
|-------------------------|-----------------|

Commercial data

| | |
|--------------------|---------------------|
| Product Group | 4 (Printed Circuit) |
| Packaging type | BOX |
| Country of origin | PL |
| GTIN | 4044918878371 |
| Customs Tariff No. | 85369010000 |

Approvals / Certificates





Country specific Approvals

| Logo | Approval | Additional Approval Text | Certificate name |
|------|----------|--------------------------|------------------|
|------|----------|--------------------------|------------------|

Subject to changes. Please also observe the further product documentation!

WAGO Kontakttechnik GmbH & Co. KG
 Hansastr. 27
 32423 Minden
 Phone: +49571 887-0 | Fax: +49571 887-169
 Email: info.de@wago.com | Web: www.wago.com

Do you have any questions about our products?
 We are always happy to take your call at +49 (571) 887-44222.

| | | | |
|--|----------------------------------|---------------|-------------|
|  | CCA DEKRA Certification B.V. | EN 60947 | NTR NL-7076 |
|  | CCA DEKRA Certification B.V. | EN 60947-7-4 | NTR NL-7267 |
|  | CSA DEKRA Certification B.V. | C22.2 No. 158 | 1565656 |
|  | ENEC DEKRA Certification B.V. | EN 60947 | 2160584.01 |

UL-Approvals

| Logo | Approval | Additional Approval Text | Certificate name |
|---|-------------------------------------|--------------------------|------------------|
|  | UL UL International Germany GmbH | UL 1059 | 20190630-E45172 |

Counterpart

Compatible products

Marking accessories

| | |
|---|--|
| Item no.: 210-331/254-202 Marking strips; as a DIN A4 sheet; MARKED; 1-16 (400x); Height of marker strip: 2.3 mm/0.091 in; Strip length 182 mm; Horizontal marking; Self-adhesive; white | www.wago.com/210-331/254-202 |
| Item no.: 210-331/254-204 Marking strips; as a DIN A4 sheet; MARKED; 17-32 (400x); Height of marker strip: 2.3 mm/0.091 in; Strip length 182 mm; Horizontal marking; Self-adhesive; white | www.wago.com/210-331/254-204 |
| Item no.: 210-331/254-206 Marking strips; as a DIN A4 sheet; MARKED; 33-48 (400x); Height of marker strip: 2.3 mm/0.091 in; Strip length 182 mm; Horizontal marking; Self-adhesive; white | www.wago.com/210-331/254-206 |

Subject to changes. Please also observe the further product documentation!

WAGO Kontakttechnik GmbH & Co. KG
 Hansastr. 27
 32423 Minden
 Phone: +49571 887-0 | Fax: +49571 887-169
 Email: info.de@wago.com | Web: www.wago.com

Do you have any questions about our products?
 We are always happy to take your call at +49 (571) 887-44222.

Item no.: 210-331/254-207

Marking strips; as a DIN A4 sheet; MARKED; 1-48 (100x); Height of marker strip: 2.3 mm/0.091 in; Strip length 182 mm; Horizontal marking; Self-adhesive; white

www.wago.com/210-331/254-207

ferrule**Item no.: 216-131**

Ferrule; Sleeve for 0.25 mm² / AWG 24; uninsulated; electro-tin plated

www.wago.com/216-131

**Item no.: 216-151**

Ferrule; Sleeve for 0.25 mm² / AWG 24; uninsulated; electro-tin plated

www.wago.com/216-151

Item no.: 216-301

Ferrule; Sleeve for 0.25 mm² / AWG 24; insulated; electro-tin plated; yellow

www.wago.com/216-301

Item no.: 216-321

Ferrule; Sleeve for 0.25 mm² / AWG 24; insulated; electro-tin plated; yellow

www.wago.com/216-321

Test Accessories**Item no.: 735-500**

Test pin; 1 mm Ø; with solder connection for test wire

www.wago.com/735-500

tools**Item no.: 210-648**

Operating tool; Blade: 2.5 x 0.4 mm; with a partially insulated shaft; angled; short

www.wago.com/210-648

**Item no.: 210-719**

Operating tool; Blade: 2.5 x 0.4 mm; with a partially insulated shaft

www.wago.com/210-719

Downloads**Documentation****Additional Information**

Technical explanations

Apr 3, 2019

pdf
3.6 MB

Download

CAD/CAE-Data**CAD data**

2D/3D Models 218-506

URL

Download

CAE data

EPLAN Data Portal 218-506

URL

Download

PCB Design

Symbol and Footprint 218-506

Subject to changes. Please also observe the further product documentation!

WAGO Kontakttechnik GmbH & Co. KG

Hansastr. 27

32423 Minden

Phone: +49571 887-0 | Fax: +49571 887-169

Email: info.de@wago.com | Web: www.wago.com

Do you have any questions about our products?

We are always happy to take your call at +49 (571) 887-44222.



[URL](#)

[Download](#)

CAX data for your PCB design, consisting of "schematic symbols and PCB footprints", allow easy integration of the WAGO component into your development environment.

Supported formats:

- Accel EDA 14 & 15
- Altium 6 to current version
- Cadence Allegro
- DesignSpark
- Eagle Libraries
- KiCad
- Mentor Graphics BoardStation
- Mentor Graphics Design Architect
- Mentor Graphics Design Expedition 99 and 2000
- OrCAD 9.X PCB and Capture
- PADS PowerPCB 3, 3.5, 4.X, and 5.X
- PADS PowerPCB and PowerLogic 3.0
- PCAD 2000, 2001, 2002, 2004, and 2006
- Pulsonix 8.5 or newer
- STL
- 3D STEP
- TARGET 3001!
- View Logic ViewDraw
- Quadcept
- Zuken CadStar 3 and 4
- Zuken CR-5000 and CR-8000

PCB Component Libraries (EDA), PCB CAD Library Ultra Librarian

Installation Notes

Conductor termination

Subject to changes. Please also observe the further product documentation!

WAGO Kontakttechnik GmbH & Co. KG
Hansastr. 27
32423 Minden
Phone: +49571 887-0 | Fax: +49571 887-169
Email: info.de@wago.com | Web: www.wago.com

Do you have any questions about our products?
We are always happy to take your call at +49 (571) 887-44222.

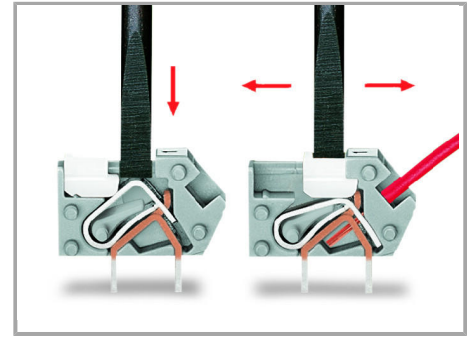
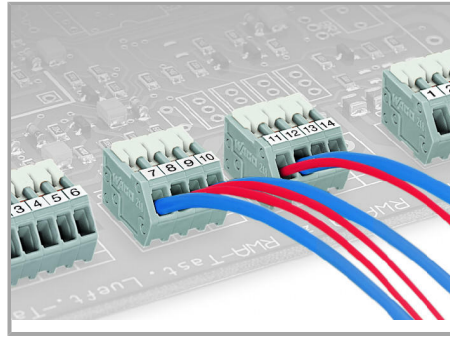
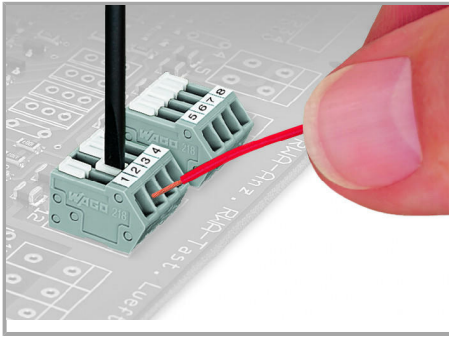

Terminating stranded conductors in confined spaces requires a great deal of patience, unless you use the new 218 Series PCB Terminal Strips. The clamping units of these strips can be held open during termination process via integrated locking slide.

Terminating 0.75 mm² (18 AWG) conductors is possible; however, insulation diameter allows only every other clamping unit to be terminated with this conductor size.

Conductor termination: To momentarily open the clamping unit, use screwdriver and then insert a stripped conductor. To open clamping unit for an extended period, move locking slide toward conductor entry hole. Then fully insert stripped conductor and move locking slide back to original position (also possible to perform with fingernail).

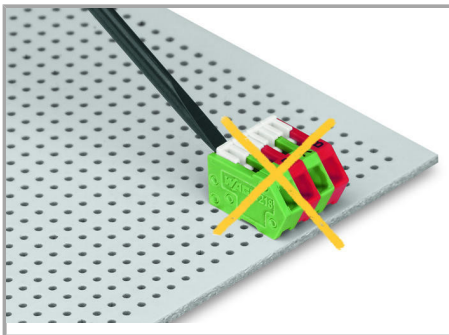

Incorrect – do not operate the locking slides from the back.

Marking

Subject to changes. Please also observe the further product documentation!

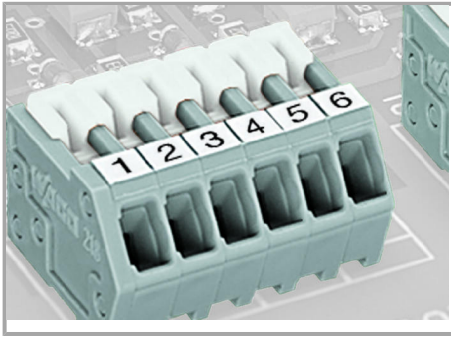

Labeling with self-adhesive marking strips.

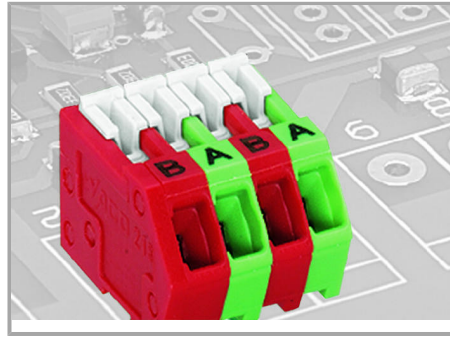

Labeling via factory direct marking.

Testing

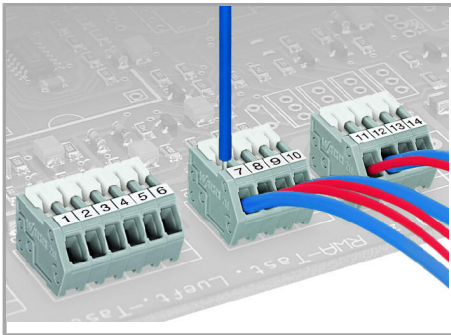

Testing directly on the clamping spring.

Subject to changes. Please also observe the further product documentation!