

**Data sheet | Item number: 2092-3353**

1-conductor THT female header; 1.4 mm Ø solder pin; angled; Gripping plate;  
2.5 mm<sup>2</sup>; Pin spacing 7.5 mm; 3-pole; 2,50 mm<sup>2</sup>; light gray

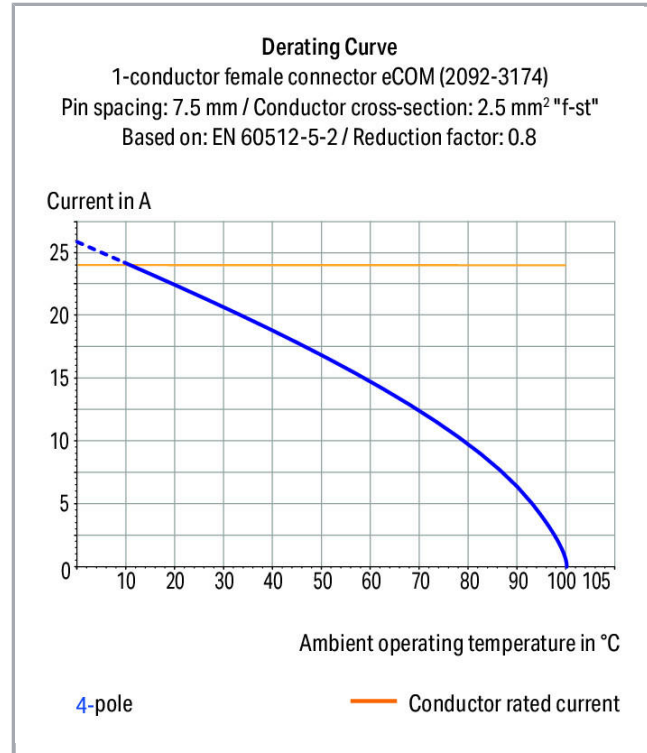

[www.wago.com/2092-3353](http://www.wago.com/2092-3353)

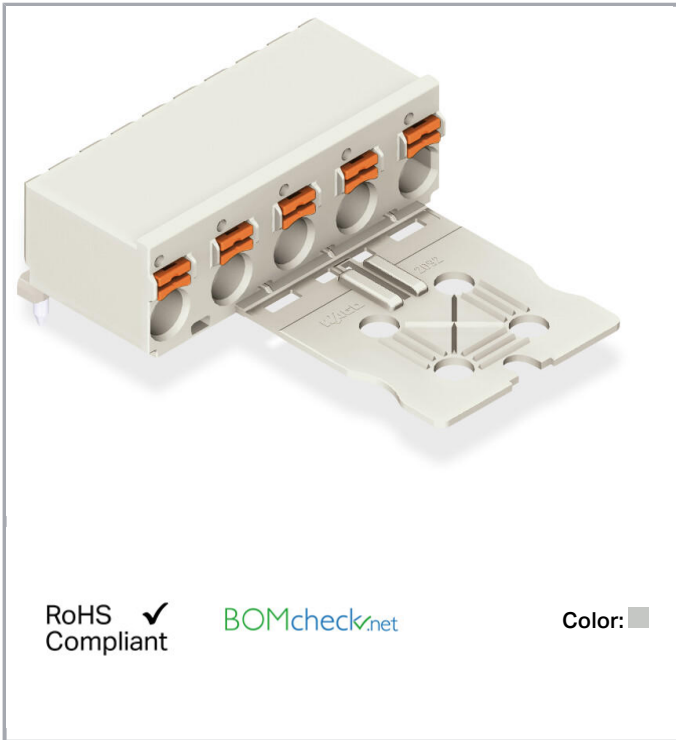

Subject to changes. Please also observe the further product documentation!

WAGO Kontakttechnik GmbH & Co. KG  
Hansastr. 27  
32423 Minden  
Phone: +49571 887-0 | Fax: +49571 887-169  
Email: [info.de@wago.com](mailto:info.de@wago.com) | Web: [www.wago.com](http://www.wago.com)

Do you have any questions about our products?  
We are always happy to take your call at +49 (571) 887-44222.

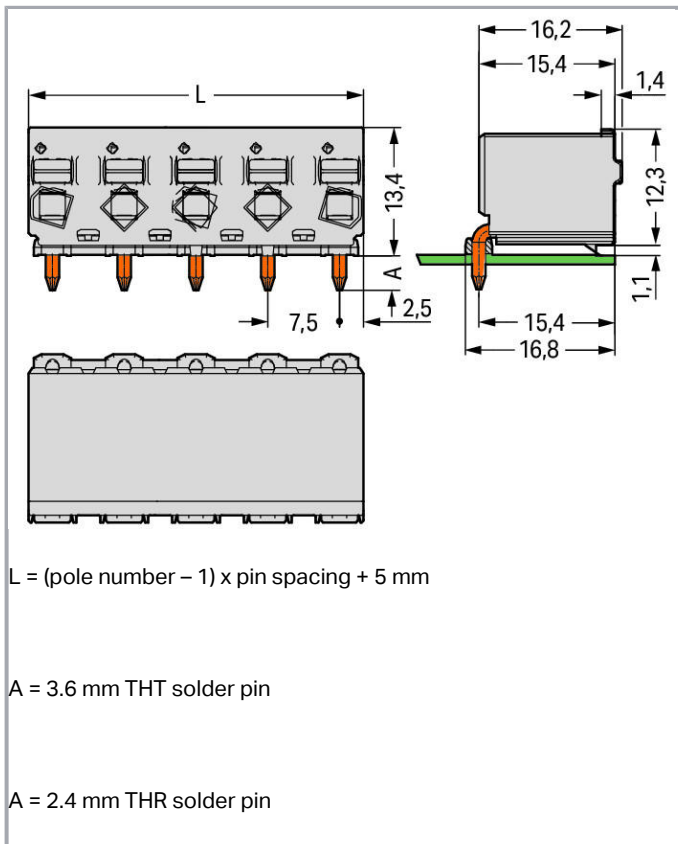

## Item description

- Universal connection for all conductor types
- Simple, push-in termination of solid and ferruled conductors
- Easy-to-use design does not require special tools
- Ability to wire while mated or unmated
- Integrated test ports for testing parallel to conductor entry
- Custom-installed solder pins

## Safety information 1:

The **picoMAX® Pluggable Connection System** includes connectors without breaking capacity in accordance with DIN EN 61984. When used as intended, these connectors must not be connected/disconnected when live or under load. The circuit design should ensure header pins, which can be touched, are not live when unmated.

## Data

### Electrical data

Subject to changes. Please also observe the further product documentation!



### Ratings per IEC/EN 60664-1

Ratings per	IEC/EN 60664-1
Rated voltage (III / 3)	400 V
Rated impulse voltage (III / 3)	6 kV
Rated voltage (III / 2)	630 V
Rated impulse voltage (III / 2)	6 kV
Rated voltage (II / 2)	1000 V
Rated impulse voltage (II / 2)	6 kV
Rated current	16 A
Legend (ratings)	(III / 2) ≙ Overvoltage category III / Pollution degree 2

### Approvals per UL 1059

Rated voltage UL (Use Group B)	300 V
Rated current UL (Use Group B)	15 A
Rated voltage UL (Use Group D)	300 V
Rated current UL (Use Group D)	10 A
Approvals per	UL 1059

### Connection data

Connection technology	Push-in CAGE CLAMP®
Actuation type	Push-button
Solid conductor	0,2 ... 2,5 mm <sup>2</sup> / 24 ... 12 AWG
Fine-stranded conductor	0,2 ... 2,5 mm <sup>2</sup> / 24 ... 12 AWG
Fine-stranded conductor with ferrule with plastic collar	0,25 ... 1,5 mm <sup>2</sup>
Fine-stranded conductor with ferrule without plastic collar	0,25 ... 2,5 mm <sup>2</sup>
Strip length	9 ... 10 mm / 0.35 ... 0.39 inch
Conductor entry angle to the PCB	0°
No. of poles	3
Total number of connection points	3
Total number of potentials	3
Number of connection types	1
Number of levels	1

### Geometrical Data

Pin spacing	7,5 mm / 0.295 inch
Width	20 mm / 0.787 inch

Subject to changes. Please also observe the further product documentation!



Height	13,4 mm / 0.528 inch
Depth	35,4 mm / 1.394 inch
Solder pin length	3.6 mm
Solder pin diameter	1.4 mm
Drilled hole diameter (tolerance)	1,6 <sup>(+0,1)</sup> mm

### Mechanical data

Design	With gripping plate
--------	---------------------

### Plug connection

Contact type (pluggable connector)	Female connector/socket
Connector connection type	for PCB
Mismating protection	No
Mating direction to the PCB	0°

### PCB contact

PCB contact	THT
-------------	-----

### Material Data

Color	light gray
Material group	I
Insulating material	Polyphthalamide (PPA GF)
Flammability class per UL94	V0
Clamping spring material	Chrome nickel spring steel (CrNi)
Contact material	Electrolytic copper (E <sub>Cu</sub> )
Contact plating	tin-plated
Fire load	0.098 MJ
Weight	4.5 g

### Environmental Requirements

Limit temperature range	-60 ... +100 °C
-------------------------	-----------------

### Commercial data

Product Group	26 (picoMAX)
Packaging type	BOX

Subject to changes. Please also observe the further product documentation!

Country of origin	DE
GTIN	4050821165439
Customs Tariff No.	85366990990

## Approvals / Certificates

### Country specific Approvals

Logo	Approval	Additional Approval Text	Certificate name
	CSA DEKRA Certification B.V.	C22.2	2362521

### UL-Approvals

Logo	Approval	Additional Approval Text	Certificate name
	UL Underwriters Laboratories Inc.	UL 1977	20190909-E45171

## Counterpart

## Downloads

### Documentation

#### Additional Information

Technical explanations	Apr 3, 2019	pdf 3.6 MB	Download
------------------------	-------------	---------------	----------

## CAD/CAE-Data

### PCB Design

Symbol and Footprint 2092-3353	URL	Download
--------------------------------	-----	----------

CAX data for your PCB design, consisting of "schematic symbols and PCB footprints", allow easy integration of the WAGO component into your development environment.

### Supported formats:

- Accel EDA 14 & 15

Subject to changes. Please also observe the further product documentation!

- Altium 6 to current version
- Cadence Allegro
- DesignSpark
- Eagle Libraries
- KiCad
- Mentor Graphics BoardStation
- Mentor Graphics Design Architect
- Mentor Graphics Design Expedition 99 and 2000
- OrCAD 9.X PCB and Capture
- PADS PowerPCB 3, 3.5, 4.X, and 5.X
- PADS PowerPCB and PowerLogic 3.0
- PCAD 2000, 2001, 2002, 2004, and 2006
- Pulsonix 8.5 or newer
- STL
- 3D STEP
- TARGET 3001!
- View Logic ViewDraw
- Quadcept
- Zuken CadStar 3 and 4
- Zuken CR-5000 and CR-8000

PCB Component Libraries (EDA), PCB CAD Library Ultra Librarian

---

## Installation Notes

### Conductor termination

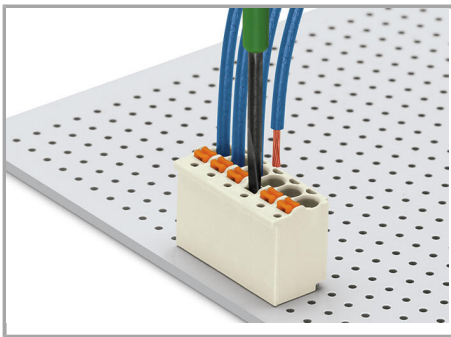

Terminating fine-stranded conductors and removing all conductor types via push-buttons.

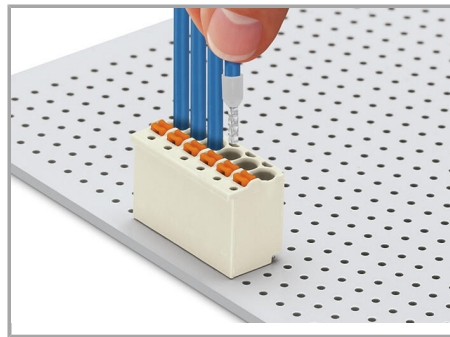

Terminating solid and ferruled conductors via push-in termination

### Marking

Subject to changes. Please also observe the further product documentation!



Pole marking via direct printing  
perpendicular to conductor entry.



Pole marking via factory direct printing.

### Testing

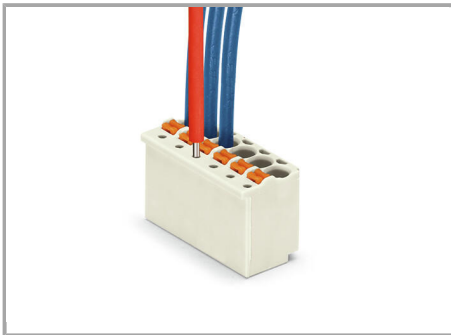

Testing with 1 mm Ø test pin, tip contact.

### Product family

[picoMAX eCOM](#)

[Show all products from the family](#)

Subject to changes. Please also observe the further product documentation!