

**Data sheet | Item number: 2092-1132**

1-conductor female plug; 2.5 mm<sup>2</sup>; Pin spacing 5 mm; 12-pole; 2,50 mm<sup>2</sup>;  
light gray

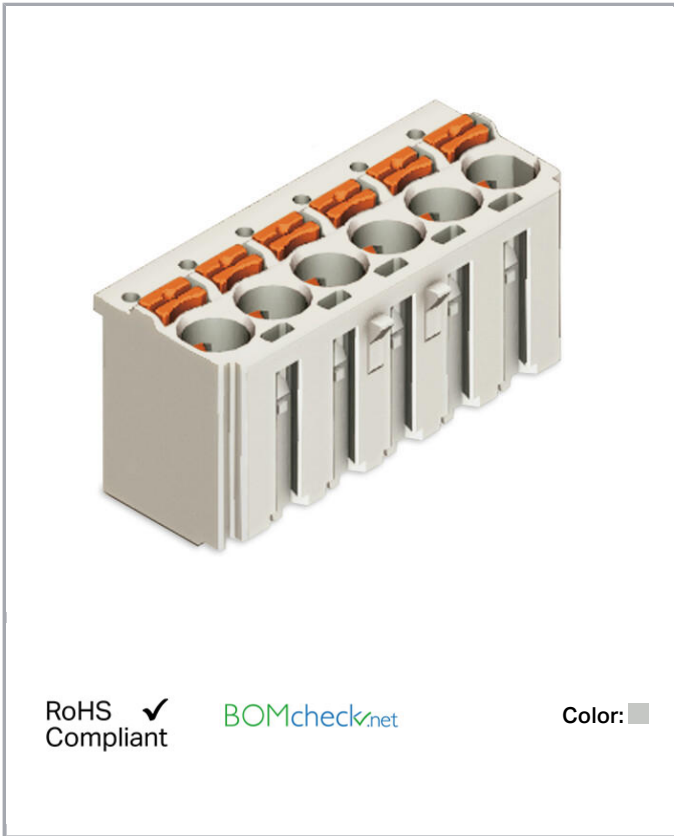

[www.wago.com/2092-1132](http://www.wago.com/2092-1132)



Subject to changes. Please also observe the further product documentation!

WAGO Kontakttechnik GmbH & Co. KG  
Hansastr. 27  
32423 Minden  
Phone: +49571 887-0 | Fax: +49571 887-169  
Email: [info.de@wago.com](mailto:info.de@wago.com) | Web: [www.wago.com](http://www.wago.com)

Do you have any questions about our products?  
We are always happy to take your call at +49 (571) 887-44222.

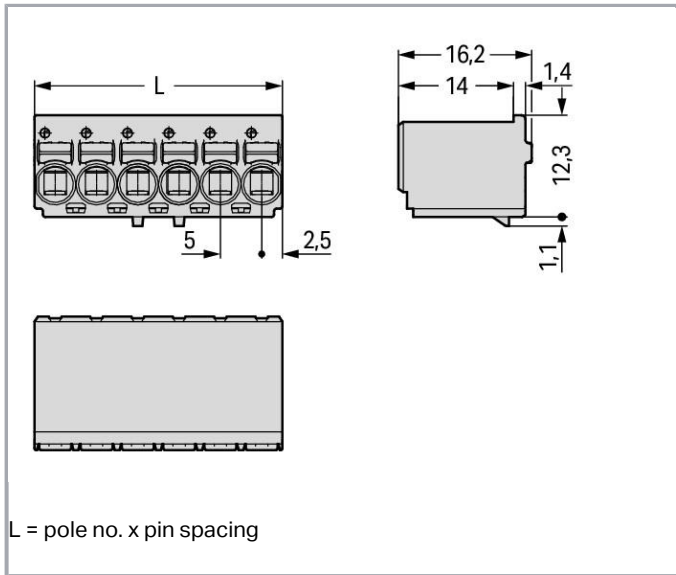

## Item description

- Universal connection of all conductor types
- Simple, push-in termination of solid and ferruled conductors
- Easy-to-use design does not require special tools
- Ability to wire while mated or unmated
- Testing parallel to conductor entry – tip contact
- Also available with gripping plates
- Integrated locking latches prevent accidental disconnection

## Safety information 1:

The **picoMAX® pluggable connection system** is designed without breaking capacity for compliance with DIN EN 61984. When used as intended, MCS Connectors shall not be connected/disconnected when live or under load. The circuit design should ensure header pins, which can be touched, are not live when unmated.

## Data

### Electrical data

### Ratings per IEC/EN 60664-1

Ratings per	IEC/EN 60664-1
Rated voltage (III / 3)	250 V
Rated impulse voltage (III / 3)	4 kV
Rated voltage (III / 2)	320 V

Subject to changes. Please also observe the further product documentation!

WAGO Kontakttechnik GmbH & Co. KG  
 Hansastr. 27  
 32423 Minden  
 Phone: +49571 887-0 | Fax: +49571 887-169  
 Email: [info.de@wago.com](mailto:info.de@wago.com) | Web: [www.wago.com](http://www.wago.com)

Do you have any questions about our products?  
 We are always happy to take your call at +49 (571) 887-44222.



Rated impulse voltage (III / 2)	4 kV
Rated voltage (II / 2)	630 V
Rated impulse voltage (II / 2)	4 kV
Rated current	16 A
Legend (ratings)	(III / 2) $\hat{=}$ Overvoltage category III / Pollution degree 2

### Approvals per UL 1059

Rated voltage UL (Use Group B)	300 V
Rated current UL (Use Group B)	15 A
Rated voltage UL (Use Group D)	300 V
Rated current UL (Use Group D)	10 A
Approvals per	UL 1059

### Connection data

Connection technology	Push-in CAGE CLAMP®
Actuation type	Push-button
Solid conductor	0.2 ... 2.5 mm <sup>2</sup> / 24 ... 12 AWG
Fine-stranded conductor	0.2 ... 2.5 mm <sup>2</sup> / 24 ... 12 AWG
Fine-stranded conductor with ferrule with plastic collar	0.25 ... 1.5 mm <sup>2</sup>
Fine-stranded conductor with ferrule without plastic collar	0.25 ... 2.5 mm <sup>2</sup>
Strip length	9 ... 10 mm / 0.35 ... 0.39 inch
No. of poles	12
Total number of connection points	12
Total number of potentials	12
Number of connection types	1
Number of levels	1

### Geometrical Data

Pin spacing	5 mm / 0.197 inch
Width	60 mm / 2.362 inch
Height	16.2 mm / 0.638 inch
Depth	13.4 mm / 0.528 inch

### Plug connection

Contact type (pluggable connector)	Female connector/socket
Connector connection type	for conductors

Subject to changes. Please also observe the further product documentation!

Mismating protection	No
----------------------	----

## Material Data

Color	light gray
Material group	I
Insulating material	Polyphthalamide (PPA GF)
Flammability class per UL94	V0
Clamping spring material	Chrome nickel spring steel (CrNi)
Contact material	Electrolytic copper (E <sub>Cu</sub> )
Contact plating	tin-plated
Fire load	0.262 MJ
Weight	11.1 g

## Environmental Requirements

Limit temperature range	-60 ... +100 °C
-------------------------	-----------------

## Commercial data

Product Group	26 (picoMAX)
Packaging type	BOX
Country of origin	DE
GTIN	4050821163541
Customs Tariff No.	85366990990

## Approvals / Certificates

### Country specific Approvals

Logo	Approval	Additional Approval Text	Certificate name
	CB DEKRA Certification B.V.	IEC 61984	NL-49737 /A1
	CSA DEKRA Certification B.V.	C22.2	2362521

### UL-Approvals

Logo	Approval	Additional Approval Text	Certificate name
	UL	UL 1977	20190909-

Subject to changes. Please also observe the further product documentation!



## Counterpart



**Item no.2092-1412**

THT male header; 1.4 mm Ø solder pin; straight; Pin spacing 5 mm; 12-pole; light gray

[www.wago.com/2092-1412](http://www.wago.com/2092-1412)



**Item no.2092-1432**

THT male header; 1.4 mm Ø solder pin; angled; Pin spacing 5 mm; 12-pole; light gray

[www.wago.com/2092-1432](http://www.wago.com/2092-1432)



**Item no.2092-1412/005-000**

THT male header; 1.4 mm Ø solder pin; straight; clamping collar; Pin spacing 5 mm; 12-pole; light gray

[www.wago.com/2092-1412/005-000](http://www.wago.com/2092-1412/005-000)



**Item no.2092-1412/200-000**

THR male header; 1.4 mm Ø solder pin; straight; Pin spacing 5 mm; 12-pole; light gray

[www.wago.com/2092-1412/200-000](http://www.wago.com/2092-1412/200-000)



**Item no.2092-1432/200-000**

THR male header; 1.4 mm Ø solder pin; angled; Pin spacing 5 mm; 12-pole; light gray

[www.wago.com/2092-1432/200-000](http://www.wago.com/2092-1432/200-000)



**Item no.2092-1432/005-000**

THT male header; 1.4 mm Ø solder pin; angled; clamping collar; Pin spacing 5 mm; 12-pole; light gray

[www.wago.com/2092-1432/005-000](http://www.wago.com/2092-1432/005-000)



**Item no.2092-1712/200-000**

Solder pin strip; 1.4 mm Ø solder pin; straight; Pin spacing 5 mm; 12-pole; black

[www.wago.com/2092-1712/200-000](http://www.wago.com/2092-1712/200-000)



**Item no.2092-1712**

Solder pin strip; 1.4 mm Ø solder pin; straight; Pin spacing 5 mm; 12-pole; black

[www.wago.com/2092-1712](http://www.wago.com/2092-1712)



**Item no.2092-1732**

Solder pin strip; 1.4 mm Ø solder pin; angled; Pin spacing 5 mm; 12-pole; black

[www.wago.com/2092-1732](http://www.wago.com/2092-1732)



**Item no.2092-1732/200-000**

Solder pin strip; 1.4 mm Ø solder pin; angled; Pin spacing 5 mm; 12-pole; black

[www.wago.com/2092-1732/200-000](http://www.wago.com/2092-1732/200-000)

Subject to changes. Please also observe the further product documentation!

WAGO Kontakttechnik GmbH & Co. KG

Hansastr. 27

32423 Minden

Phone: +49571 887-0 | Fax: +49571 887-169

Email: [info.de@wago.com](mailto:info.de@wago.com) | Web: [www.wago.com](http://www.wago.com)

Do you have any questions about our products?

We are always happy to take your call at +49 (571) 887-44222.

## Compatible products

### Strain relief plate

Item no.: 2092-1603  
Gripping plate; light gray

[www.wago.com/2092-1603](http://www.wago.com/2092-1603)

Item no.: 2092-1603/002-000  
Gripping plate with sliding connector release; light gray

[www.wago.com/2092-1603/002-000](http://www.wago.com/2092-1603/002-000)

### Test Accessories



Item no.: 735-500  
Test pin; 1 mm Ø; with solder connection for test wire

[www.wago.com/735-500](http://www.wago.com/735-500)

### tools



Item no.: 2092-1630  
Unlocking tool; orange

[www.wago.com/2092-1630](http://www.wago.com/2092-1630)



Item no.: 210-719  
Operating tool; Blade: 2.5 x 0.4 mm; with a partially insulated shaft

[www.wago.com/210-719](http://www.wago.com/210-719)

## Downloads

### Documentation

#### Additional Information

Technical explanations

Apr 3, 2019

pdf  
3.6 MB

[Download](#)

### CAD/CAE-Data

#### CAD data

2D/3D Models 2092-1132

[URL](#)

[Download](#)

## Installation Notes

### Locking

Subject to changes. Please also observe the further product documentation!

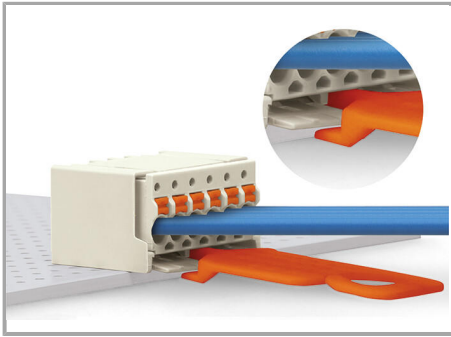

Disconnecting female connector via unlocking tool. Plug unlocking tool into the male header's locking latch.

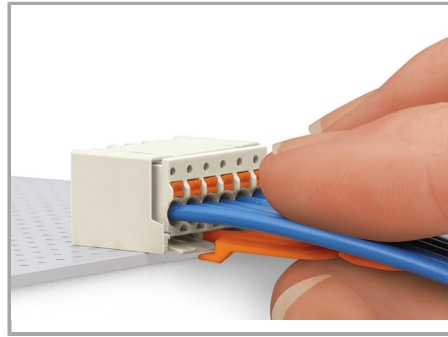

Insert unlocking tool until it hits backstop. Wedge opens locking latch.

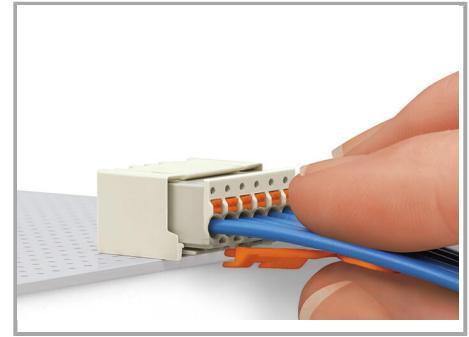

Pull on both unlocking tool and conductors to remove female connector from male header.

### Inserting a conductor

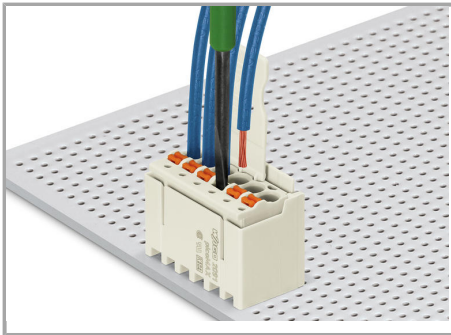

Inserting fine-stranded conductor into mated female connector via push-button.

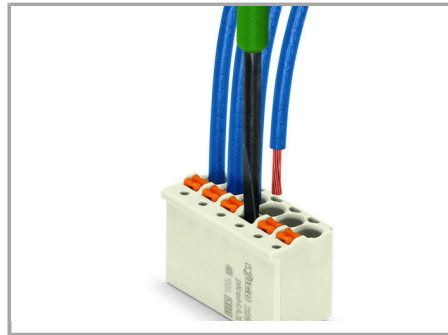

Inserting fine-stranded conductor into unmated female connector via push-button.

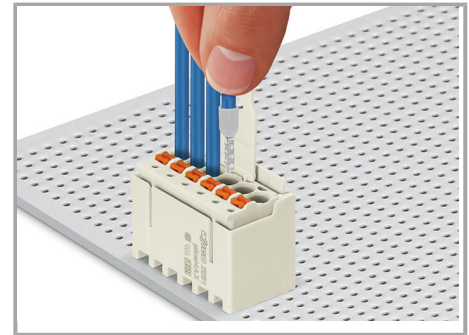

Inserting solid and ferruled conductors via push-in termination

### Marking



Pole marking via factory direct printing.

### Coding

Subject to changes. Please also observe the further product documentation!

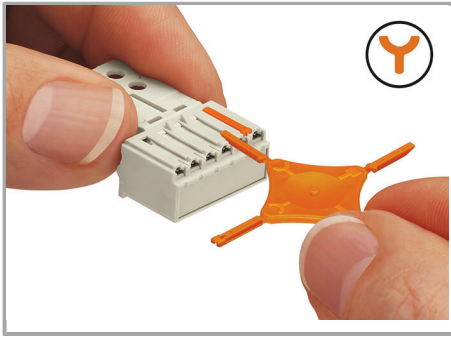

Coding a female connector (via coding key carrier and two keys for female connector, see symbol).

#### Testing

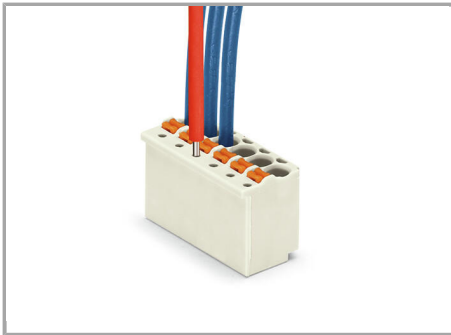

Testing with 1 mm Ø test pin, tip contact.

#### Product family

picoMAX

[Show all products from the family](#)

Subject to changes. Please also observe the further product documentation!