

Data sheet | Item number: 2092-1124/000-1000

1-conductor female plug; direct marking; 2.5 mm²; Pin spacing 5 mm; 4-pole;
2,50 mm²; light gray

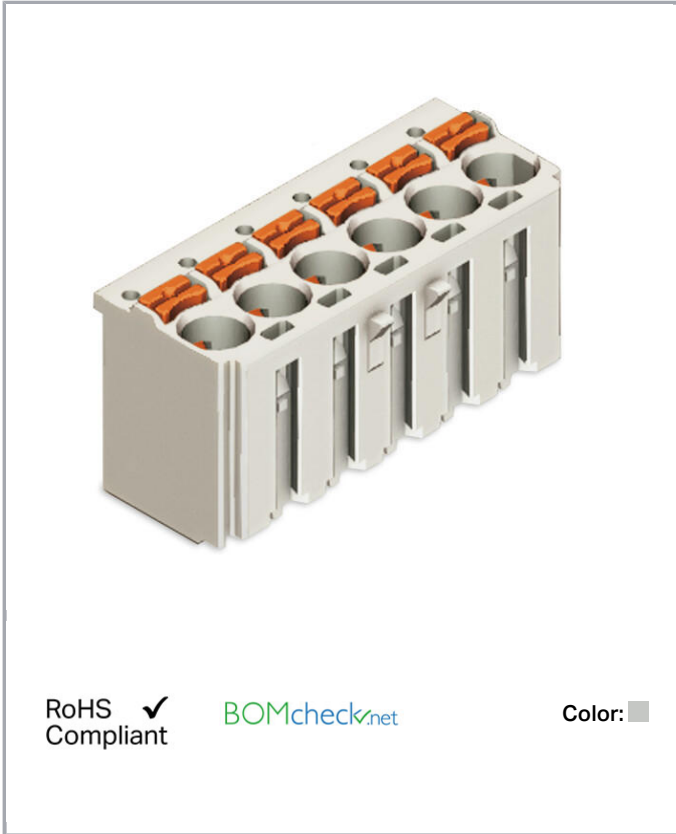

www.wago.com/2092-1124/000-1000



Subject to changes. Please also observe the further product documentation!

WAGO Kontakttechnik GmbH & Co. KG
Hansastr. 27
32423 Minden
Phone: +49571 887-0 | Fax: +49571 887-169
Email: info.de@wago.com | Web: www.wago.com

Do you have any questions about our products?
We are always happy to take your call at +49 (571) 887-44222.

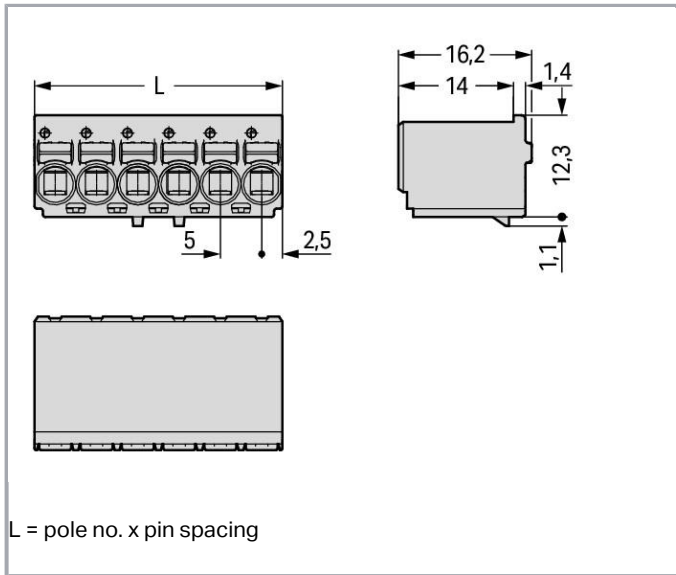

Item description

- Universal connection of all conductor types
- Simple, push-in termination of solid and ferruled conductors
- Easy-to-use design does not require special tools
- Ability to wire while mated or unmated
- Testing parallel to conductor entry – tip contact
- Also available with gripping plates
- Integrated locking latches prevent accidental disconnection

Safety information 1:

The **picoMAX® pluggable connection system** is designed without breaking capacity for compliance with DIN EN 61984. When used as intended, MCS Connectors shall not be connected/disconnected when live or under load. The circuit design should ensure header pins, which can be touched, are not live when unmated.

Data

Electrical data

Ratings per IEC/EN 60664-1

Ratings per	IEC/EN 60664-1
Rated voltage (III / 3)	250 V
Rated impulse voltage (III / 3)	4 kV
Rated voltage (III / 2)	320 V

Subject to changes. Please also observe the further product documentation!

WAGO Kontakttechnik GmbH & Co. KG
 Hansastr. 27
 32423 Minden
 Phone: +49571 887-0 | Fax: +49571 887-169
 Email: info.de@wago.com | Web: www.wago.com

Do you have any questions about our products?
 We are always happy to take your call at +49 (571) 887-44222.



Rated impulse voltage (III / 2)	4 kV
Rated voltage (II / 2)	630 V
Rated impulse voltage (II / 2)	4 kV
Rated current	16 A
Legend (ratings)	(III / 2) $\hat{=}$ Overvoltage category III / Pollution degree 2

Approvals per UL 1059

Rated voltage UL (Use Group B)	300 V
Rated current UL (Use Group B)	15 A
Rated voltage UL (Use Group D)	300 V
Rated current UL (Use Group D)	10 A
Approvals per	UL 1059

Connection data

Connection technology	Push-in CAGE CLAMP®
Actuation type	Push-button
Solid conductor	0.2 ... 2.5 mm ² / 24 ... 12 AWG
Fine-stranded conductor	0.2 ... 2.5 mm ² / 24 ... 12 AWG
Fine-stranded conductor with ferrule with plastic collar	0.25 ... 1.5 mm ²
Fine-stranded conductor with ferrule without plastic collar	0.25 ... 2.5 mm ²
Strip length	9 ... 10 mm / 0.35 ... 0.39 inch
No. of poles	4
Total number of connection points	4
Total number of potentials	4
Number of connection types	1
Number of levels	1

Geometrical Data

Pin spacing	5 mm / 0.197 inch
Width	20 mm / 0.787 inch
Height	16.2 mm / 0.638 inch
Depth	13.4 mm / 0.528 inch

Plug connection

Contact type (pluggable connector)	Female connector/socket
Connector connection type	for conductors

Subject to changes. Please also observe the further product documentation!

Mismating protection	No
----------------------	----

Material Data

Color	light gray
Material group	I
Insulating material	Polyphthalamide (PPA GF)
Flammability class per UL94	V0
Clamping spring material	Chrome nickel spring steel (CrNi)
Contact material	Electrolytic copper (E _{Cu})
Contact plating	tin-plated
Fire load	0.086 MJ
Weight	3.7 g

Environmental Requirements

Limit temperature range	-60 ... +100 °C
-------------------------	-----------------

Commercial data

Packaging type	BOX
Country of origin	DE
GTIN	4050821357780
Customs Tariff No.	85366990990

Approvals / Certificates

Country specific Approvals

Logo	Approval	Additional Approval Text	Certificate name
	CB DEKRA Certification B.V.	IEC 61984	NL-49737 /A1
	CSA DEKRA Certification B.V.	C22.2	2362521

UL-Approvals

Logo	Approval	Additional Approval Text	Certificate name
	UL Underwriters Laboratories Inc.	UL 1977	20190909- E45171

Subject to changes. Please also observe the further product documentation!



Counterpart



Item no.2092-1424

THT male header; 1.4 mm Ø solder pin; angled; Pin spacing 5 mm; 4-pole; light gray

www.wago.com/2092-1424



Item no.2092-1404

THT male header; 1.4 mm Ø solder pin; straight; Pin spacing 5 mm; 4-pole; light gray

www.wago.com/2092-1404



Item no.2092-1524/002-000

1-conductor male connector; Gripping plate; 2.5 mm²; Pin spacing 5 mm; 4-pole; 2,50 mm²; light gray

www.wago.com/2092-1524/002-000

Compatible products

Test Accessories



Item no.: 735-500

Test pin; 1 mm Ø; with solder connection for test wire

www.wago.com/735-500

Strain relief plate

Item no.: 2092-1601

Gripping plate; light gray

www.wago.com/2092-1601

Item no.: 2092-1601/002-000

Gripping plate with sliding connector release; light gray

www.wago.com/2092-1601/002-000

tools



Item no.: 2092-1630

Unlocking tool; orange

www.wago.com/2092-1630



Item no.: 210-719

Operating tool; Blade: 2.5 x 0.4 mm; with a partially insulated shaft

www.wago.com/210-719

Downloads

Documentation

Additional Information

Subject to changes. Please also observe the further product documentation!

WAGO Kontakttechnik GmbH & Co. KG

Hansastr. 27

32423 Minden

Phone: +49571 887-0 | Fax: +49571 887-169

Email: info.de@wago.com | Web: www.wago.com

Do you have any questions about our products?

We are always happy to take your call at +49 (571) 887-44222.

Installation Notes

Locking

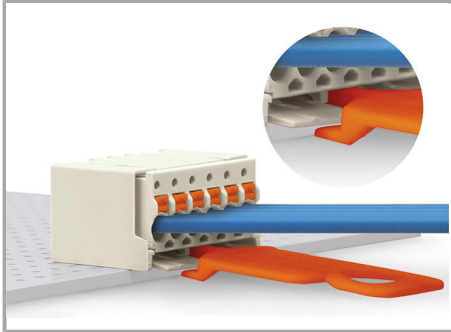

Disconnecting female connector via unlocking tool. Plug unlocking tool into the male header's locking latch.

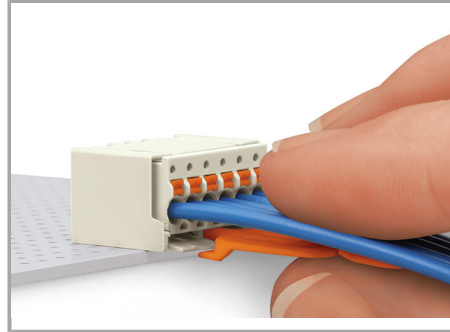

Insert unlocking tool until it hits backstop. Wedge opens locking latch.

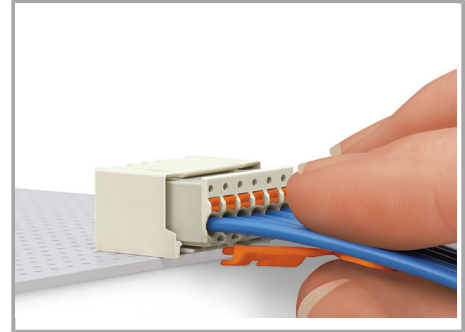

Pull on both unlocking tool and conductors to remove female connector from male header.

Inserting a conductor

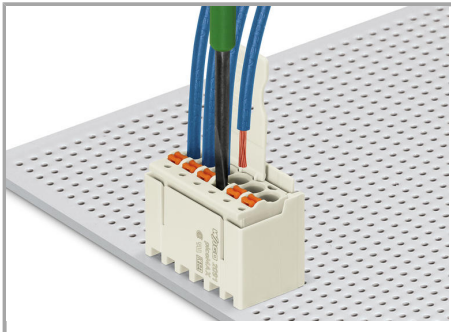

Inserting fine-stranded conductor into mated female connector via push-button.

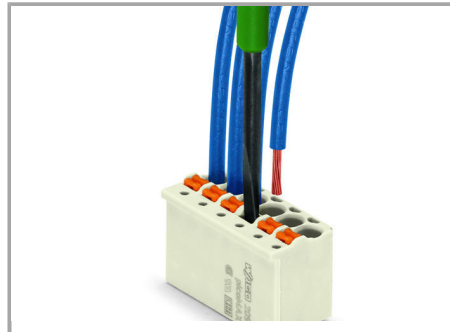

Inserting fine-stranded conductor into unmated female connector via push-button.

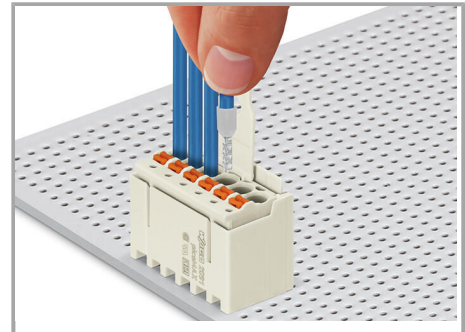

Inserting solid and ferruled conductors via push-in termination

Marking

Subject to changes. Please also observe the further product documentation!



Pole marking via factory direct printing.

Coding

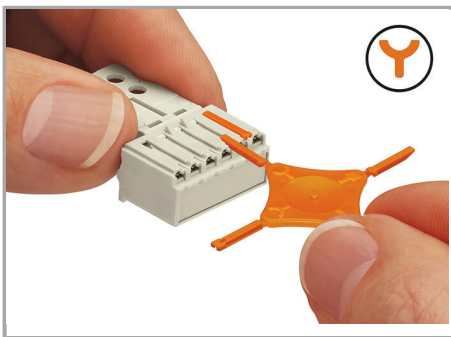

Coding a female connector (via coding key carrier and two keys for female connector, see symbol).

Testing

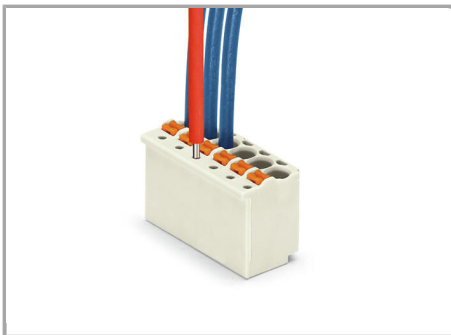

Testing with 1 mm Ø test pin, tip contact.

Product family

picoMAX

[Show all products from the family](#)

Subject to changes. Please also observe the further product documentation!