

Data sheet | Item number: 2042-3064

Relay module; Nominal input voltage: 24 VDC; 1 break and 1 make contact;
Limiting continuous current: 8 A; Path; Green status indicator; Module width:
20 mm

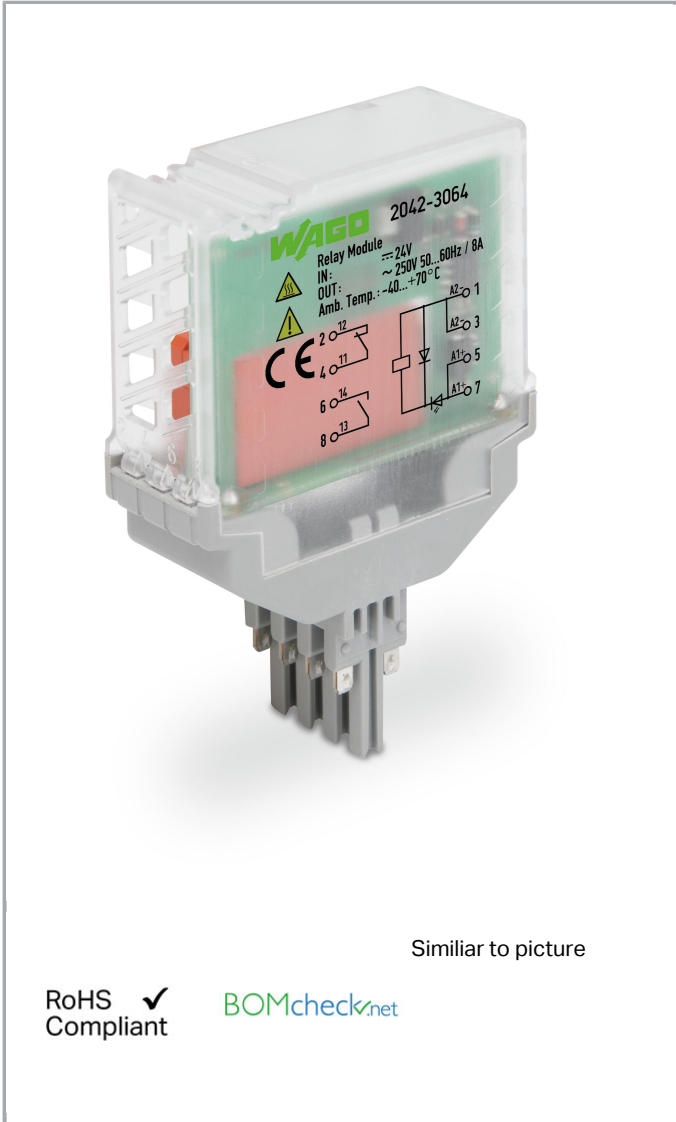

www.wago.com/2042-3064



Similar to picture

RoHS Compliant

[BOMcheck.net](https://www.bomcheck.net)

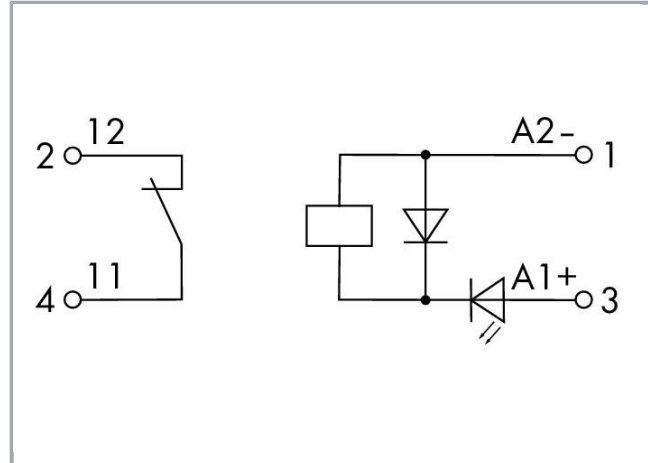

Subject to changes. Please also observe the further product documentation!

WAGO Kontakttechnik GmbH & Co. KG
Hansastr. 27
32423 Minden
Phone: +49571 887-0 | Fax: +49571 887-169
Email: info.de@wago.com | Web: www.wago.com

Do you have any questions about our products?
We are always happy to take your call at +49 (571) 887-44222.

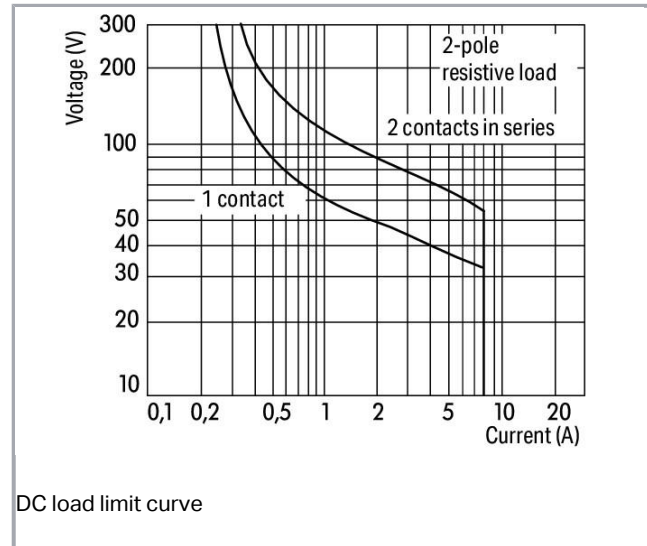
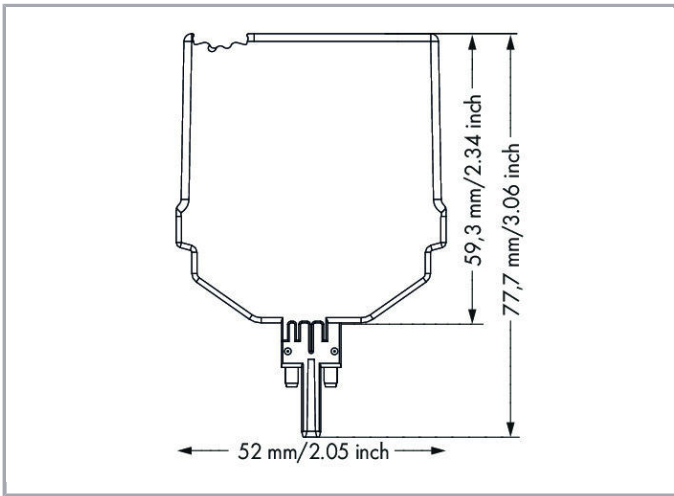

Data

Technical Data

Control circuit

Nominal input voltage U_N	DC 24 V
Input voltage range	-30 ... +25 %
Nominal input current at U_N	13,8 mA

Load circuit:

Number of break contacts/switch off contacts	1
Number of make contacts/switch on contacts	1
Contact material (relay)	AgNi
Limiting continuous current	8 A
Max. make current (resistive)	(AC) 15 A / 4 s
Max. switching voltage	AC 250 V
Max. switching power (resistive)	AC 2000 VA; DC (see load limit curve)
Recommended minimum load	12 V / 10 mA
Pull-in time (typ.)	8 ms
Drop-out time (typ.)	6 ms
Bounce time (typ.)	4 ms
Electrical life (N.O.; resistive load; 23 °C)	100 x 10 ³ switching operations
Mechanical life	10 x 10 ⁶ switching operations

Subject to changes. Please also observe the further product documentation!



Signaling

Status indication	Green LED
-------------------	-----------

Safety and protection:

Rated voltage	250 V
Pollution degree	2
Dielectric strength, control/load circuit (AC, 1 min)	3 kVrms
Dielectric strength open contact (AC, 1 min)	1 kVrms
Dielectric strength, channel/channel (AC, 1 min)	1.5 kV _{rms}
Protection class	IP20

Geometrical Data

Width	20,7 mm / 0.815 inch
Height	77,7 mm / 3.059 inch
Height from the surface	59,3 mm / 2.335 inch
Depth	52 mm / 2.047 inch

Mechanical data

Type of mounting	Pluggable module for TOPJOB® S carrier terminal block
------------------	---

Material Data

Flammability class per UL94	V0
Weight	37.1 g

Environmental Requirements

Surrounding air (operating) temperature at U _N	-40 ... 70 °C
Surrounding air (storage) temperature	-40 ... 85 °C
Processing temperature	-25 ... +50 °C
Max. operating altitude	2000 m

Standards and specifications

Standards/specifications	EN 61010-2-201; EN 61373; EN 50121-3-2
--------------------------	--

Subject to changes. Please also observe the further product documentation!

WAGO Kontakttechnik GmbH & Co. KG
 Hansastr. 27
 32423 Minden
 Phone: +49571 887-0 | Fax: +49571 887-169
 Email: info.de@wago.com | Web: www.wago.com

Do you have any questions about our products?
 We are always happy to take your call at +49 (571) 887-44222.

Commercial data

Packaging type	BOX
Country of origin	DE
GTIN	4055143651714
Customs Tariff No.	85364900990

Approvals / Certificates



UL-Approvals

Logo	Approval	Additional Approval Text	Certificate name
	UL Underwriters Laboratories Inc. (ORDINARY LOCATIONS)	UL 61010-1	E175199

Counterpart

Compatible products

End plate

	Item no.: 2002-1691 End and intermediate plate; 1 mm thick; gray	www.wago.com/2002-1691
	Item no.: 2002-1692 End and intermediate plate; 1 mm thick; orange	www.wago.com/2002-1692
	Item no.: 2002-1791 End and intermediate plate; 1 mm thick; gray	www.wago.com/2002-1791
	Item no.: 2002-1792 End and intermediate plate; 1 mm thick; orange	www.wago.com/2002-1792
	Item no.: 2002-1891 End and intermediate plate; 1 mm thick; gray	www.wago.com/2002-1891
	Item no.: 2002-1892 End and intermediate plate; 1 mm thick; orange	www.wago.com/2002-1892

Marking accessories

Item no.: 2009-110

Subject to changes. Please also observe the further product documentation!

Marking strips; on reel; not stretchable; plain; snap-on type; white

www.wago.com/2009-110



Item no.: 2009-115

WMB-Inline; for Smart Printer; 1500 pieces on roll; stretchable 5 - 5.2 mm; plain; snap-on type; white

www.wago.com/2009-115



Item no.: 2009-115/000-002

WMB-Inline; for Smart Printer; 1500 pieces on roll; stretchable 5 - 5.2 mm; plain; snap-on type; yellow

www.wago.com/2009-115

/000-002



Item no.: 2009-115/000-006

WMB-Inline; for Smart Printer; 1500 pieces on roll; stretchable 5 - 5.2 mm; plain; snap-on type; white

www.wago.com/2009-115

/000-006

Item no.: 2009-115/000-007

WMB-Inline; for Smart Printer; 1500 pieces on roll; stretchable 5 - 5.2 mm; plain; snap-on type; gray

www.wago.com/2009-115

/000-007



Item no.: 2009-115/000-012

WMB-Inline; for Smart Printer; 1500 pieces on roll; stretchable 5 - 5.2 mm; plain; snap-on type; white

www.wago.com/2009-115

/000-012

Item no.: 2009-115/000-017

WMB-Inline; for Smart Printer; 1500 pieces on roll; stretchable 5 - 5.2 mm; plain; snap-on type; white

www.wago.com/2009-115

/000-017



Item no.: 2009-115/000-023

WMB-Inline; for Smart Printer; 1500 pieces on roll; stretchable 5 - 5.2 mm; plain; snap-on type; green

www.wago.com/2009-115

/000-023

Item no.: 2009-115/000-024

WMB-Inline; for Smart Printer; 1500 pieces on roll; stretchable 5 - 5.2 mm; plain; snap-on type; white

www.wago.com/2009-115

/000-024



Item no.: 793-501

WMB marking card; as card; not stretchable; plain; snap-on type; white

www.wago.com/793-501



Item no.: 793-501/000-002

WMB marking card; as card; not stretchable; plain; snap-on type; yellow

www.wago.com/793-501

/000-002



Item no.: 793-501/000-005

WMB marking card; as card; not stretchable; plain; snap-on type; red

www.wago.com/793-501

/000-005

Item no.: 793-501/000-006

WMB marking card; as card; not stretchable; plain; snap-on type; blue

www.wago.com/793-501

/000-006



Item no.: 793-501/000-007

WMB marking card; as card; not stretchable; plain; snap-on type; gray

www.wago.com/793-501

/000-007

Subject to changes. Please also observe the further product documentation!

WAGO Kontakttechnik GmbH & Co. KG

Hansastr. 27













32423 Minden

Phone: +49571 887-0 | Fax: +49571 887-169

Email: info.de@wago.com | Web: www.wago.com

Do you have any questions about our products?



We are always happy to take your call at +49 (571) 887-44222.

	<p>Item no.: 793-501/000-012 WMB marking card; as card; not stretchable; plain; snap-on type; orange</p>	<p>www.wago.com/793-501/000-012</p>
	<p>Item no.: 793-501/000-017 WMB marking card; as card; not stretchable; plain; snap-on type; light green</p>	<p>www.wago.com/793-501/000-017</p>
	<p>Item no.: 793-501/000-023 WMB marking card; as card; not stretchable; plain; snap-on type; green</p>	<p>www.wago.com/793-501/000-023</p>
	<p>Item no.: 793-501/000-024 WMB marking card; as card; not stretchable; plain; snap-on type; violet</p>	<p>www.wago.com/793-501/000-024</p>
	<p>Item no.: 793-5501 WMB marking card; as card; for terminal block width 5 - 17.5 mm; stretchable 5 - 5.2 mm; plain; snap-on type; white</p>	<p>www.wago.com/793-5501</p>
	<p>Item no.: 793-5501/000-002 WMB marking card; as card; for terminal block width 5 - 17.5 mm; stretchable 5 - 5.2 mm; plain; snap-on type; yellow</p>	<p>www.wago.com/793-5501/000-002</p>
	<p>Item no.: 793-5501/000-005 WMB marking card; as card; for terminal block width 5 - 17.5 mm; stretchable 5 - 5.2 mm; plain; snap-on type; red</p>	<p>www.wago.com/793-5501/000-005</p>
	<p>Item no.: 793-5501/000-006 WMB marking card; as card; for terminal block width 5 - 17.5 mm; stretchable 5 - 5.2 mm; plain; snap-on type; blue</p>	<p>www.wago.com/793-5501/000-006</p>
	<p>Item no.: 793-5501/000-007 WMB marking card; as card; for terminal block width 5 - 17.5 mm; stretchable 5 - 5.2 mm; plain; snap-on type; gray</p>	<p>www.wago.com/793-5501/000-007</p>
	<p>Item no.: 793-5501/000-012 WMB marking card; as card; for terminal block width 5 - 17.5 mm; stretchable 5 - 5.2 mm; plain; snap-on type; orange</p>	<p>www.wago.com/793-5501/000-012</p>
	<p>Item no.: 793-5501/000-014 WMB marking card; as card; for terminal block width 5 - 17.5 mm; stretchable 5 - 5.2 mm; plain; snap-on type; brown</p>	<p>www.wago.com/793-5501/000-014</p>
	<p>Item no.: 793-5501/000-017 WMB marking card; as card; for terminal block width 5 - 17.5 mm; stretchable 5 - 5.2 mm; plain; snap-on type; green</p>	<p>www.wago.com/793-5501/000-017</p>
	<p>Item no.: 793-5501/000-023 WMB marking card; as card; for terminal block width 5 - 17.5 mm; stretchable 5 - 5.2 mm; plain; snap-on type; light green</p>	<p>www.wago.com/793-5501/000-023</p>
	<p>Item no.: 793-5501/000-024 WMB marking card; as card; for terminal block width 5 - 17.5 mm; stretchable 5 - 5.2 mm; plain; snap-on type; violet</p>	<p>www.wago.com/793-5501/000-024</p>

Subject to changes. Please also observe the further product documentation!

on type; violet

Terminal Block

	Item no.: 2002-1661 2-conductor carrier terminal block; for DIN-rail 35 x 15 and 35 x 7.5; 2.5 mm ² ; Push-in CAGE CLAMP®; www.wago.com/2002-1661 2,50 mm ² ; gray
	Item no.: 2002-1761 3-conductor carrier terminal block; for DIN-rail 35 x 15 and 35 x 7.5; 2.5 mm ² ; Push-in CAGE CLAMP®; www.wago.com/2002-1761 2,50 mm ² ; gray
	Item no.: 2002-1861 4-conductor carrier terminal block; for DIN-rail 35 x 15 and 35 x 7.5; 2.5 mm ² ; Push-in CAGE CLAMP®; www.wago.com/2002-1861 2,50 mm ² ; gray
	Item no.: 2002-1961 2-conductor carrier terminal block; with additional jumper position; for DIN-rail 35 x 15 and 35 x 7.5; www.wago.com/2002-1961 2.5 mm ² ; Push-in CAGE CLAMP®; 2,50 mm ² ; gray

Downloads

Documentation

Instruction Leaflet

Pluggable Relay Module / Pluggable Solid-State Relay Module	V 1.1.0	pdf 2.0 MB	Download
---	---------	---------------	----------

Additional Information

Disposal; Electrical and electronic equipment, Packaging	V 1.0.0	pdf 265.8 kB	Download
--	---------	-----------------	----------

CAD/CAE-Data

CAD data

2D/3D Models 2042-3064	URL	Download
------------------------	-----	----------

Installation Notes

Subject to changes. Please also observe the further product documentation!

WAGO Kontakttechnik GmbH & Co. KG
 Hansastr. 27
 32423 Minden
 Phone: +49571 887-0 | Fax: +49571 887-169
 Email: info.de@wago.com | Web: www.wago.com

Do you have any questions about our products?
 We are always happy to take your call at +49 (571) 887-44222.