

Data sheet | Item number: 2022-2201

1-conductor/1-pin double deck receptacle terminal block; for DIN-rail 35 x 15 and 35 x 7.5; 2.5 mm²; Push-in CAGE CLAMP®; 2,50 mm²; gray

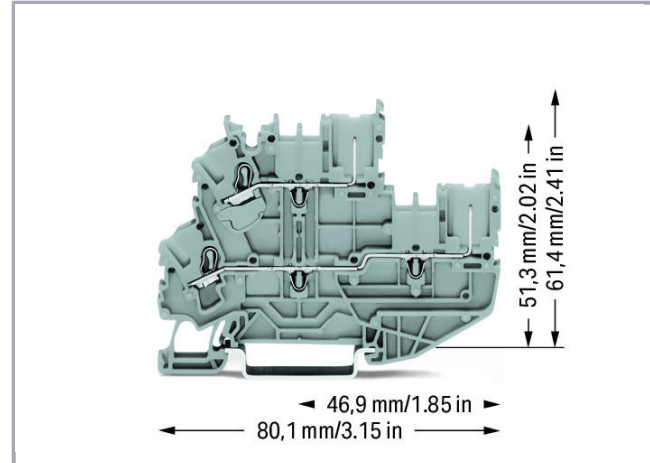

www.wago.com/2022-2201

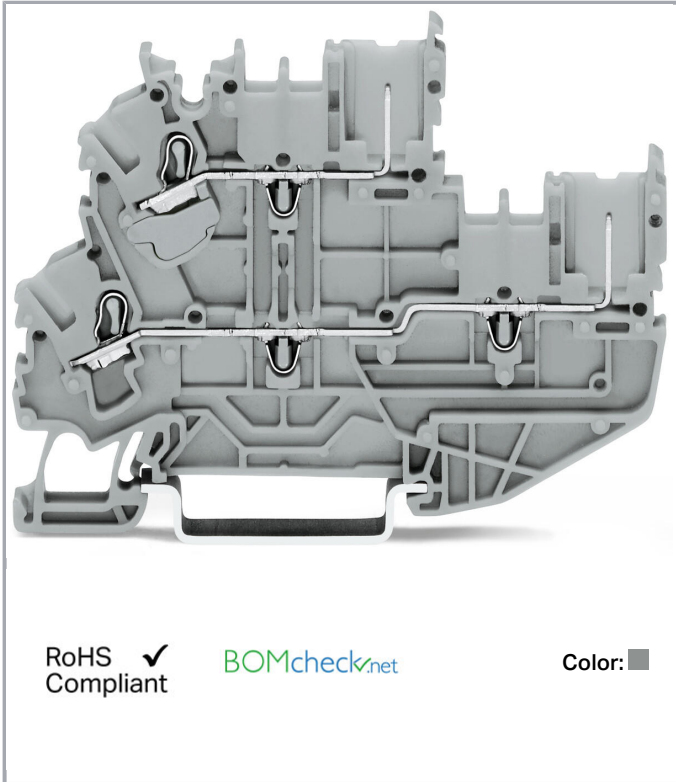

RoHS Compliant

[BOMcheck.net](https://www.bomcheck.net)

Color:

Data

Electrical data

Ratings per IEC/EN 60664-1

Ratings per	IEC/EN 60947-7-1
Rated voltage (III / 3)	690 V
Rated impulse voltage (III / 3)	6 kV
Rated current	24 A
Rated current (2)	28 A
Legend (ratings)	(III / 3) ≙ Overvoltage category III / Pollution degree 3

Connection data

Connection technology

Push-in CAGE CLAMP®

Subject to changes. Please also observe the further product documentation!

WAGO Kontakttechnik GmbH & Co. KG
Hansastr. 27
32423 Minden
Phone: +49571 887-0 | Fax: +49571 887-169
Email: info.de@wago.com | Web: www.wago.com

Do you have any questions about our products?
We are always happy to take your call at +49 (571) 887-44222.



Actuation type	Open Tool Slot Push-in
Connectable conductor materials	Copper
Nominal cross section	2.5 mm ²
Solid conductor	0.25 ... 4 mm ² / 22 ... 12 AWG
Solid conductor, push-in termination	0.75 ... 4 mm ² / 18 ... 12 AWG
Fine-stranded conductor	0.25 ... 4 mm ² / 22 ... 12 AWG
Fine-stranded conductor with ferrule with plastic collar	1 ... 2.5 mm ² / 18 ... 12 AWG
Fine-stranded conductor with ferrule, push-in termination, from	1 ... 2.5 mm ² / 18 ... 12 AWG
Strip length	10 ... 12 mm / 0.39 ... 0.47 inch
Total number of connection points	2
Total number of potentials	2
Number of levels	2
Type of wiring	Front-entry wiring
Note (conductor cross-section)	Depending on the conductor characteristic, a conductor with a smaller cross section can also be inserted via push-in termination.

Geometrical Data

Width	5.2 mm / 0.205 inch
Height from upper-edge of DIN-35 rail	51.3 mm / 2.02 inch
Depth	80.1 mm / 3.154 inch

Mechanical data

Design	horizontal
Type of mounting	DIN-35 rail
Potential marking	L/L
Marking level	Side marking

Material Data

Color	gray
Insulating material	Polyamide 66 (PA 66)
Fire load	0.245 MJ
Weight	11.3 g

Commercial data

Product Group	18 (X-COM-System)
Packaging type	BOX

Subject to changes. Please also observe the further product documentation!



WAGO Kontakttechnik GmbH & Co. KG
 Hansastr. 27
 32423 Minden
 Phone: +49571 887-0 | Fax: +49571 887-169
 Email: info.de@wago.com | Web: www.wago.com

Do you have any questions about our products?
 We are always happy to take your call at +49 (571) 887-44222.





Country of origin	CN
GTIN	4050821892373
Customs Tariff No.	85366990990

Approvals / Certificates

Country specific Approvals

Logo	Approval	Additional Approval Text	Certificate name
	CCA DEKRA Certification B.V.	EN 60947	NTR NL 7628
	CSA DEKRA Certification B.V.	C22.2 No. 158	2437422
	KEMA/KEUR DEKRA Certification B.V.	EN 60947, EN 61984	71- 101201

Ship Approvals

Logo	Approval	Additional Approval Text	Certificate name
	ABS American Bureau of Shipping	EN 60947	20- HG1941090- PDA
	BV Bureau Veritas S.A.	EN 60947	38586/A0 BV
	DNV GL Det Norske Veritas, Germanischer Lloyd	-	TAE00001V2
	LR Lloyds Register	EN 60947	91/20112 (E9)

UL-Approvals

Certificate

Subject to changes. Please also observe the further product documentation!

WAGO Kontakttechnik GmbH & Co. KG
 Hansastr. 27
 32423 Minden
 Phone: +49571 887-0 | Fax: +49571 887-169
 Email: info.de@wago.com | Web: www.wago.com



Do you have any questions about our products?
 We are always happy to take your call at +49 (571) 887-44222.

Logo	Approval	Additional Approval Text	name
	UR Underwriters Laboratories Inc.	UL 1059	E45172

Counterpart

Compatible products

Push-In type wire jumper

	Item no.: 2009-412 Push-in type wire jumper; insulated; wire length 60 mm; Conductor cross section 1.5 mm ² ; suitable for 2001, 2002, 2003 and 2022 Series rail-mounted terminal blocks; black	www.wago.com/2009-412
	Item no.: 2009-414 Push-in type wire jumper; insulated; wire length 110 mm; Conductor cross section 1.5 mm ² ; suitable for 2001, 2002, 2003 and 2022 Series rail-mounted terminal blocks; black	www.wago.com/2009-414
	Item no.: 2009-416 Push-in type wire jumper; insulated; wire length 250 mm; Conductor cross section 1.5 mm ² ; suitable for 2001, 2002, 2003 and 2022 Series rail-mounted terminal blocks; black	www.wago.com/2009-416

tools

Item no.: 210-720 Operating tool; Blade: 3.5 x 0.5 mm; with a partially insulated shaft	www.wago.com/210-720
---	--









Protective Warning Marker

	Item no.: 2002-115 Protective warning marker; with high-voltage symbol, black; for 5 terminal blocks; yellow	www.wago.com/2002-115
--	--	--

Jumper

	Item no.: 2002-400 Adjacent jumper for continuous commoning; insulated; 2-way; Nominal current 25 A; light gray	www.wago.com/2002-400
	Item no.: 2002-402	

Subject to changes. Please also observe the further product documentation!

	Push-in type jumper bar; insulated; 2-way; Nominal current 25 A; light gray	www.wago.com/2002-402
	Item no.: 2002-402/000-005 Push-in type jumper bar; insulated; 2-way; Nominal current 25 A; red	www.wago.com/2002-402/000-005
	Item no.: 2002-402/000-006 Push-in type jumper bar; insulated; 2-way; Nominal current 25 A; blue	www.wago.com/2002-402/000-006
	Item no.: 2002-403 Push-in type jumper bar; insulated; 3-way; Nominal current 25 A; light gray	www.wago.com/2002-403
	Item no.: 2002-403/000-005 Push-in type jumper bar; insulated; 3-way; Nominal current 25 A; red	www.wago.com/2002-403/000-005
	Item no.: 2002-403/000-006 Push-in type jumper bar; insulated; 3-way; Nominal current 25 A; blue	www.wago.com/2002-403/000-006
	Item no.: 2002-404 Push-in type jumper bar; insulated; 4-way; Nominal current 25 A; light gray	www.wago.com/2002-404
	Item no.: 2002-404/000-005 Push-in type jumper bar; insulated; 4-way; Nominal current 25 A; red	www.wago.com/2002-404/000-005
	Item no.: 2002-404/000-006 Push-in type jumper bar; insulated; 4-way; Nominal current 25 A; blue	www.wago.com/2002-404/000-006
	Item no.: 2002-405 Push-in type jumper bar; insulated; 5-way; Nominal current 25 A; light gray	www.wago.com/2002-405
	Item no.: 2002-405/000-005 Push-in type jumper bar; insulated; 5-way; Nominal current 25 A; red	www.wago.com/2002-405/000-005
	Item no.: 2002-405/000-006 Push-in type jumper bar; insulated; 5-way; Nominal current 25 A; blue	www.wago.com/2002-405/000-006
	Item no.: 2002-405/011-000 Star point jumper; insulated; 3-way (1-3-5); IN = IN terminal block; light gray	www.wago.com/2002-405/011-000
	Item no.: 2002-406 Push-in type jumper bar; insulated; 6-way; Nominal current 25 A; light gray	www.wago.com/2002-406
	Item no.: 2002-406/000-005 Push-in type jumper bar; insulated; 6-way; Nominal current 25 A; red	www.wago.com/2002-406/000-005

Subject to changes. Please also observe the further product documentation!



Item no.: 2002-406/000-006
Push-in type jumper bar; insulated; 6-way; Nominal current 25 A; blue

www.wago.com/2002-406/000-006



Item no.: 2002-406/020-000
Delta jumper; insulated; 1-2 3-4 5-6; IN = IN terminal block; light gray

www.wago.com/2002-406/020-000

Item no.: 2002-407
Push-in type jumper bar; insulated; 7-way; Nominal current 25 A; light gray

www.wago.com/2002-407

Item no.: 2002-407/000-005
Push-in type jumper bar; insulated; 7-way; Nominal current 25 A; red

www.wago.com/2002-407/000-005



Item no.: 2002-407/000-006
Push-in type jumper bar; insulated; 7-way; Nominal current 25 A; blue

www.wago.com/2002-407/000-006



Item no.: 2002-408
Push-in type jumper bar; insulated; 8-way; Nominal current 25 A; light gray

www.wago.com/2002-408

Item no.: 2002-408/000-005
Push-in type jumper bar; insulated; 8-way; Nominal current 25 A; red

www.wago.com/2002-408/000-005



Item no.: 2002-408/000-006
Push-in type jumper bar; insulated; 8-way; Nominal current 25 A; blue

www.wago.com/2002-408/000-006

Item no.: 2002-409
Push-in type jumper bar; insulated; 9-way; Nominal current 25 A; light gray

www.wago.com/2002-409

Item no.: 2002-409/000-005
Push-in type jumper bar; insulated; 9-way; Nominal current 25 A; red

www.wago.com/2002-409/000-005

Item no.: 2002-409/000-006
Push-in type jumper bar; insulated; 9-way; Nominal current 25 A; blue

www.wago.com/2002-409/000-006



Item no.: 2002-410
Push-in type jumper bar; insulated; 10-way; Nominal current 25 A; light gray

www.wago.com/2002-410



Item no.: 2002-410/000-005
Push-in type jumper bar; insulated; 10-way; Nominal current 25 A; red







www.wago.com/2002-410/000-005













Item no.: 2002-410/000-006
Push-in type jumper bar; insulated; 10-way; Nominal current 25 A; blue

www.wago.com/2002-410/000-006

Subject to changes. Please also observe the further product documentation!

	Item no.: 2002-423 Adjacent jumper for continuous commoning; insulated; from 1 to 3; Nominal current 25 A; light gray	www.wago.com/2002-423
	Item no.: 2002-423/000-005 Adjacent jumper for continuous commoning; insulated; from 1 to 3; Nominal current 25 A; red	www.wago.com/2002-423/000-005
	Item no.: 2002-423/000-006 Adjacent jumper for continuous commoning; insulated; from 1 to 3; Nominal current 25 A; blue	www.wago.com/2002-423/000-006
	Item no.: 2002-433 Push-in type jumper bar; insulated; from 1 to 3; Nominal current 25 A; light gray	www.wago.com/2002-433
	Item no.: 2002-434 Push-in type jumper bar; insulated; from 1 to 4; Nominal current 25 A; light gray	www.wago.com/2002-434
	Item no.: 2002-435 Push-in type jumper bar; insulated; from 1 to 5; Nominal current 25 A; light gray	www.wago.com/2002-435
	Item no.: 2002-436 Push-in type jumper bar; insulated; from 1 to 6; Nominal current 25 A; light gray	www.wago.com/2002-436
	Item no.: 2002-437 Push-in type jumper bar; insulated; from 1 to 7; Nominal current 25 A; light gray	www.wago.com/2002-437
	Item no.: 2002-438 Push-in type jumper bar; insulated; from 1 to 8; Nominal current 25 A; light gray	www.wago.com/2002-438
	Item no.: 2002-439 Push-in type jumper bar; insulated; from 1 to 9; Nominal current 25 A; light gray	www.wago.com/2002-439
	Item no.: 2002-440 Push-in type jumper bar; insulated; from 1 to 10; Nominal current 25 A; light gray	www.wago.com/2002-440
	Item no.: 2002-472 Staggered jumper; insulated; 2-way; Nominal current 25 A; suitable for 2002 and 2003 Series rail-mounted terminal blocks; light gray	www.wago.com/2002-472
	Item no.: 2002-473 Staggered jumper; insulated; 3-way; Nominal current 25 A; suitable for 2002 and 2003 Series rail-mounted terminal blocks; light gray	www.wago.com/2002-473
	Item no.: 2002-473/011-000 Ready-made staggered jumper; insulated; 2-way (1-3); Nominal current 25 A; with contact lugs broken off at the factory and circuit marking; light gray	www.wago.com/2002-473/011-000
	Item no.: 2002-474 Staggered jumper; insulated; 4-way; Nominal current 25 A; suitable for 2002 and 2003 Series rail-mounted terminal blocks; light gray	www.wago.com/2002-474
	Item no.: 2002-475 Staggered jumper; insulated; 5-way; Nominal current 25 A; suitable for 2002 and 2003 Series rail-mounted terminal blocks; light gray	www.wago.com/2002-475

Subject to changes. Please also observe the further product documentation!

	Item no.: 2002-475/011-000 Ready-made staggered jumper; insulated; 3-way (1-3-5); Nominal current 25 A; with contact lugs broken off at the factory and circuit marking; light gray	www.wago.com/2002-475/011-000
	Item no.: 2002-476 Staggered jumper; insulated; 6-way; Nominal current 25 A; suitable for 2002 and 2003 Series rail-mounted terminal blocks; light gray	www.wago.com/2002-476
	Item no.: 2002-477 Staggered jumper; insulated; 7-way; Nominal current 25 A; suitable for 2002 and 2003 Series rail-mounted terminal blocks; light gray	www.wago.com/2002-477
	Item no.: 2002-477/011-000 Ready-made staggered jumper; insulated; 1-3-5-7; Nominal current 25 A; with contact lugs broken off at the factory and circuit marking; light gray	www.wago.com/2002-477/011-000
	Item no.: 2002-478 Staggered jumper; insulated; 8-way; Nominal current 25 A; suitable for 2002 and 2003 Series rail-mounted terminal blocks; light gray	www.wago.com/2002-478
	Item no.: 2002-479 Staggered jumper; insulated; 9-way; Nominal current 25 A; suitable for 2002 and 2003 Series rail-mounted terminal blocks; light gray	www.wago.com/2002-479
	Item no.: 2002-479/011-000 Ready-made staggered jumper; insulated; 1-3-5-7-9; Nominal current 25 A; with contact lugs broken off at the factory and circuit marking; light gray	www.wago.com/2002-479/011-000
	Item no.: 2002-480 Staggered jumper; insulated; 10-way; Nominal current 25 A; suitable for 2002 and 2003 Series rail-mounted terminal blocks; light gray	www.wago.com/2002-480
	Item no.: 2002-481 Staggered jumper; insulated; 11-way; Nominal current 25 A; suitable for 2002 and 2003 Series rail-mounted terminal blocks; light gray	www.wago.com/2002-481
	Item no.: 2002-481/011-000 Ready-made staggered jumper; insulated; 1-3-5-7-9-11; Nominal current 25 A; with contact lugs broken off at the factory and circuit marking; light gray	www.wago.com/2002-481/011-000
	Item no.: 2002-482 Staggered jumper; insulated; 12-way; Nominal current 25 A; suitable for 2002 and 2003 Series rail-mounted terminal blocks; light gray	www.wago.com/2002-482
	Item no.: 2002-492 Double-deck vertical jumper; insulated; light gray	www.wago.com/2002-492
	Item no.: 2002-492/000-012 Double-deck vertical jumper; insulated; orange	www.wago.com/2002-492/000-012
	Item no.: 210-103 Wire commoning chain; insulated; 50 connections; black	www.wago.com/210-103
	Item no.: 210-123 Wire commoning chain; insulated; 50 connections	www.wago.com/210-123

Marking accessories

Subject to changes. Please also observe the further product documentation!



Item no.: 2002-121
Adaptor

www.wago.com/2002-121



Item no.: 2002-161
Adaptor

www.wago.com/2002-161

Item no.: 2009-110
Marking strips; on reel; not stretchable; plain; snap-on type; white

www.wago.com/2009-110



Item no.: 2009-115
WMB-Inline; for Smart Printer; 1500 pieces on roll; stretchable 5 - 5.2 mm; plain; snap-on type; white

www.wago.com/2009-115



Item no.: 2009-115/000-002
WMB-Inline; for Smart Printer; 1500 pieces on roll; stretchable 5 - 5.2 mm; plain; snap-on type; yellow

[www.wago.com/2009-115 /000-002](http://www.wago.com/2009-115/000-002)



Item no.: 2009-115/000-006
WMB-Inline; for Smart Printer; 1500 pieces on roll; stretchable 5 - 5.2 mm; plain; snap-on type; white

[www.wago.com/2009-115 /000-006](http://www.wago.com/2009-115/000-006)



Item no.: 2009-115/000-007
WMB-Inline; for Smart Printer; 1500 pieces on roll; stretchable 5 - 5.2 mm; plain; snap-on type; gray

[www.wago.com/2009-115 /000-007](http://www.wago.com/2009-115/000-007)

Item no.: 2009-115/000-012
WMB-Inline; for Smart Printer; 1500 pieces on roll; stretchable 5 - 5.2 mm; plain; snap-on type; white

[www.wago.com/2009-115 /000-012](http://www.wago.com/2009-115/000-012)

Item no.: 2009-115/000-017
WMB-Inline; for Smart Printer; 1500 pieces on roll; stretchable 5 - 5.2 mm; plain; snap-on type; white

[www.wago.com/2009-115 /000-017](http://www.wago.com/2009-115/000-017)

Item no.: 2009-115/000-023
WMB-Inline; for Smart Printer; 1500 pieces on roll; stretchable 5 - 5.2 mm; plain; snap-on type; green

[www.wago.com/2009-115 /000-023](http://www.wago.com/2009-115/000-023)



Item no.: 2009-115/000-024
WMB-Inline; for Smart Printer; 1500 pieces on roll; stretchable 5 - 5.2 mm; plain; snap-on type; white

[www.wago.com/2009-115 /000-024](http://www.wago.com/2009-115/000-024)



Item no.: 2009-145
Mini-WSB Inline; for Smart Printer; 1700 pieces on roll; stretchable 5 - 5.2 mm; plain; snap-on type; white

www.wago.com/2009-145



Item no.: 2009-145/000-002
Mini-WSB Inline; for Smart Printer; 1700 pieces on roll; stretchable 5 - 5.2 mm; plain; snap-on type; white

[www.wago.com/2009-145 /000-002](http://www.wago.com/2009-145/000-002)











Item no.: 2009-145/000-005
Mini-WSB Inline; for Smart Printer; 1700 pieces on roll; stretchable 5 - 5.2 mm; plain; snap-on type; red











[www.wago.com/2009-145 /000-005](http://www.wago.com/2009-145/000-005)

Item no.: 2009-145/000-006

Subject to changes. Please also observe the further product documentation!

	Mini-WSB Inline; for Smart Printer; 1700 pieces on roll; stretchable 5 - 5.2 mm; plain; snap-on type; blue	www.wago.com/2009-145/000-006
	Item no.: 2009-145/000-007 Mini-WSB Inline; for Smart Printer; 1700 pieces on roll; stretchable 5 - 5.2 mm; plain; snap-on type; white	www.wago.com/2009-145/000-007
	Item no.: 2009-145/000-012 Mini-WSB Inline; for Smart Printer; 1700 pieces on roll; stretchable 5 - 5.2 mm; plain; snap-on type; orange	www.wago.com/2009-145/000-012
	Item no.: 2009-145/000-023 Mini-WSB Inline; for Smart Printer; 1700 pieces on roll; stretchable 5 - 5.2 mm; plain; snap-on type; green	www.wago.com/2009-145/000-023
	Item no.: 2009-145/000-024 Mini-WSB Inline; for Smart Printer; 1700 pieces on roll; stretchable 5 - 5.2 mm; plain; snap-on type; violet	www.wago.com/2009-145/000-024
	Item no.: 2009-191 Group marker carrier	www.wago.com/2009-191
	Item no.: 2009-192 Group marker carrier	www.wago.com/2009-192
	Item no.: 2009-193 Group marker carrier	www.wago.com/2009-193
	Item no.: 2009-198 Adaptor	www.wago.com/2009-198
	Item no.: 248-501 Miniature WSB Quick marking system; plain; Marker width 5 mm; 10 strips with 10 markers per card	www.wago.com/248-501
	Item no.: 248-501/000-002 Mini-WSB marking card; as card; not stretchable; plain; snap-on type; yellow	www.wago.com/248-501/000-002
	Item no.: 248-501/000-005 Mini-WSB marking card; as card; not stretchable; plain; snap-on type; red	www.wago.com/248-501/000-005
	Item no.: 248-501/000-006 Mini-WSB marking card; as card; not stretchable; plain; snap-on type; blue	www.wago.com/248-501/000-006
	Item no.: 248-501/000-007 Mini-WSB marking card; as card; not stretchable; plain; snap-on type; gray	www.wago.com/248-501/000-007
	Item no.: 248-501/000-012 Mini-WSB marking card; as card; not stretchable; plain; snap-on type; orange	www.wago.com/248-501/000-012

Subject to changes. Please also observe the further product documentation!

	<p>Item no.: 248-501/000-017 Mini-WSB marking card; as card; not stretchable; plain; snap-on type; light green</p>	<p>www.wago.com/248-501/000-017</p>
	<p>Item no.: 248-501/000-023 Mini-WSB marking card; as card; not stretchable; plain; snap-on type; green</p>	<p>www.wago.com/248-501/000-023</p>
	<p>Item no.: 248-501/000-024 Mini-WSB marking card; as card; not stretchable; plain; snap-on type; violet</p>	<p>www.wago.com/248-501/000-024</p>
	<p>Item no.: 793-501 WMB marking card; as card; not stretchable; plain; snap-on type; white</p>	<p>www.wago.com/793-501</p>
	<p>Item no.: 793-501/000-002 WMB marking card; as card; not stretchable; plain; snap-on type; yellow</p>	<p>www.wago.com/793-501/000-002</p>
	<p>Item no.: 793-501/000-005 WMB marking card; as card; not stretchable; plain; snap-on type; red</p>	<p>www.wago.com/793-501/000-005</p>
	<p>Item no.: 793-501/000-006 WMB marking card; as card; not stretchable; plain; snap-on type; blue</p>	<p>www.wago.com/793-501/000-006</p>
	<p>Item no.: 793-501/000-007 WMB marking card; as card; not stretchable; plain; snap-on type; gray</p>	<p>www.wago.com/793-501/000-007</p>
	<p>Item no.: 793-501/000-012 WMB marking card; as card; not stretchable; plain; snap-on type; orange</p>	<p>www.wago.com/793-501/000-012</p>
	<p>Item no.: 793-501/000-017 WMB marking card; as card; not stretchable; plain; snap-on type; light green</p>	<p>www.wago.com/793-501/000-017</p>
	<p>Item no.: 793-501/000-023 WMB marking card; as card; not stretchable; plain; snap-on type; green</p>	<p>www.wago.com/793-501/000-023</p>
	<p>Item no.: 793-501/000-024 WMB marking card; as card; not stretchable; plain; snap-on type; violet</p>	<p>www.wago.com/793-501/000-024</p>
	<p>Item no.: 793-5501 WMB marking card; as card; for terminal block width 5 - 17.5 mm; stretchable 5 - 5.2 mm; plain; snap-on type; white</p>	<p>www.wago.com/793-5501</p>
	<p>Item no.: 793-5501/000-002</p>	

Subject to changes. Please also observe the further product documentation!

WMB marking card; as card; for terminal block width 5 - 17.5 mm; stretchable 5 - 5.2 mm; plain; snap-on type; yellow

www.wago.com/793-5501/000-002

Item no.: 793-5501/000-005

WMB marking card; as card; for terminal block width 5 - 17.5 mm; stretchable 5 - 5.2 mm; plain; snap-on type; red

www.wago.com/793-5501/000-005



Item no.: 793-5501/000-006

WMB marking card; as card; for terminal block width 5 - 17.5 mm; stretchable 5 - 5.2 mm; plain; snap-on type; blue

www.wago.com/793-5501/000-006



Item no.: 793-5501/000-007

WMB marking card; as card; for terminal block width 5 - 17.5 mm; stretchable 5 - 5.2 mm; plain; snap-on type; gray

www.wago.com/793-5501/000-007



Item no.: 793-5501/000-012

WMB marking card; as card; for terminal block width 5 - 17.5 mm; stretchable 5 - 5.2 mm; plain; snap-on type; orange

www.wago.com/793-5501/000-012



Item no.: 793-5501/000-017

WMB marking card; as card; for terminal block width 5 - 17.5 mm; stretchable 5 - 5.2 mm; plain; snap-on type; green

www.wago.com/793-5501/000-017



Item no.: 793-5501/000-023

WMB marking card; as card; for terminal block width 5 - 17.5 mm; stretchable 5 - 5.2 mm; plain; snap-on type; light green

www.wago.com/793-5501/000-023

Item no.: 793-5501/000-024

WMB marking card; as card; for terminal block width 5 - 17.5 mm; stretchable 5 - 5.2 mm; plain; snap-on type; violet

www.wago.com/793-5501/000-024

ferrule

Item no.: 216-241

Ferrule; Sleeve for 0.5 mm² / 20 AWG; insulated; electro-tin plated; electrolytic copper; gastight crimped; acc. to DIN 46228, Part 4/09.90; white

www.wago.com/216-241

Item no.: 216-242

Ferrule; Sleeve for 0.75 mm² / 18 AWG; insulated; electro-tin plated; electrolytic copper; gastight crimped; acc. to DIN 46228, Part 4/09.90; gray

www.wago.com/216-242



Item no.: 216-243

Ferrule; Sleeve for 1 mm² / AWG 18; insulated; electro-tin plated; electrolytic copper; gastight crimped; acc. to DIN 46228, Part 4/09.90; red

www.wago.com/216-243



Item no.: 216-244

Ferrule; Sleeve for 1.5 mm² / AWG 16; insulated; electro-tin plated; electrolytic copper; gastight crimped; acc. to DIN 46228, Part 4/09.90; black

www.wago.com/216-244



Item no.: 216-246

Ferrule; Sleeve for 2.5 mm² / AWG 14; insulated; electro-tin plated; electrolytic copper; gastight crimped; acc. to DIN 46228, Part 4/09.90; blue

www.wago.com/216-246



Item no.: 216-262

Ferrule; Sleeve for 0.75 mm² / 18 AWG; insulated; electro-tin plated; electrolytic copper; gastight crimped; acc. to DIN 46228, Part 4/09.90; gray

www.wago.com/216-262

Subject to changes. Please also observe the further product documentation!

WAGO Kontakttechnik GmbH & Co. KG

Hansastr. 27





32423 Minden

Phone: +49571 887-0 | Fax: +49571 887-169





Email: info.de@wago.com | Web: www.wago.com

Do you have any questions about our products?







We are always happy to take your call at +49 (571) 887-44222.

	Item no.: 216-263 Ferrule; Sleeve for 1 mm ² / AWG 18; insulated; electro-tin plated; electrolytic copper; gastight crimped; acc. to DIN 46228, Part 4/09.90; red	www.wago.com/216-263
	Item no.: 216-264 Ferrule; Sleeve for 1.5 mm ² / AWG 16; insulated; electro-tin plated; electrolytic copper; gastight crimped; acc. to DIN 46228, Part 4/09.90; black	www.wago.com/216-264
	Item no.: 216-266 Ferrule; Sleeve for 2.5 mm ² / AWG 14; insulated; electro-tin plated; electrolytic copper; gastight crimped; acc. to DIN 46228, Part 4/09.90; blue	www.wago.com/216-266
	Item no.: 216-284 Ferrule; Sleeve for 1.5 mm ² / AWG 16; insulated; electro-tin plated; electrolytic copper; gastight crimped; acc. to DIN 46228, Part 4/09.90; black	www.wago.com/216-284
	Item no.: 216-286 Ferrule; Sleeve for 2.5 mm ² / AWG 14; insulated; electro-tin plated; electrolytic copper; gastight crimped; acc. to DIN 46228, Part 4/09.90; blue	www.wago.com/216-286
Female plug		
	Item no.: 2022-101 1-conductor female plug; 2.5 mm ² ; 1-pole; 2,50 mm ² ; gray	www.wago.com/2022-101
	Item no.: 2022-101/000-006 1-conductor female plug; 1-pole; 2,50 mm ² ; blue	www.wago.com/2022-101/000-006
	Item no.: 2022-101/000-012 1-conductor female plug; 1-pole; 2,50 mm ² ; orange	www.wago.com/2022-101/000-012
	Item no.: 2022-101/000-016 1-conductor female plug; 1-pole; 2,50 mm ² ; green-yellow	www.wago.com/2022-101/000-016
	Item no.: 2022-101/122-000 1-conductor female plug; 1-pole; 2,50 mm ² ; gray	www.wago.com/2022-101/122-000
	Item no.: 2022-101/122-006 1-conductor female plug; 1-pole; 2,50 mm ² ; blue	www.wago.com/2022-101/122-006
	Item no.: 2022-101/122-016 1-conductor female plug; 1-pole; 2,50 mm ² ; green-yellow	www.wago.com/2022-101/122-016
	Item no.: 2022-101/132-000 1-conductor female plug; Strain relief plate; 1-pole; 2,50 mm ² ; gray	www.wago.com/2022-101/132-000
	Item no.: 2022-101/132-006 1-conductor female plug; Strain relief plate; 1-pole; 2,50 mm ² ; blue	www.wago.com/2022-101/132-006











Subject to changes. Please also observe the further product documentation!

	Item no.: 2022-101/132-016 1-conductor female plug; Strain relief plate; 1-pole; 2,50 mm ² ; green-yellow	www.wago.com/2022-101/132-016
	Item no.: 2022-101/142-000 1-conductor female plug; Strain relief plate; 1-pole; 2,50 mm ² ; gray	www.wago.com/2022-101/142-000
	Item no.: 2022-101/142-006 1-conductor female plug; Strain relief plate; 1-pole; 2,50 mm ² ; blue	www.wago.com/2022-101/142-006
	Item no.: 2022-101/142-016 1-conductor female plug; Strain relief plate; 1-pole; 2,50 mm ² ; green-yellow	www.wago.com/2022-101/142-016
	Item no.: 2022-102 1-conductor female plug; 2.5 mm ² ; 2-pole; 2,50 mm ² ; gray	www.wago.com/2022-102
	Item no.: 2022-102/000-006 1-conductor female plug; 2.5 mm ² ; 2-pole; 2,50 mm ² ; blue	www.wago.com/2022-102/000-006
	Item no.: 2022-102/000-016 1-conductor female plug; 2.5 mm ² ; 2-pole; 2,50 mm ² ; green-yellow	www.wago.com/2022-102/000-016
	Item no.: 2022-102/122-000 1-conductor female plug; Locking lever; 2.5 mm ² ; 2-pole; 2,50 mm ² ; gray	www.wago.com/2022-102/122-000
	Item no.: 2022-102/132-000 1-conductor female plug; Strain relief plate; 2.5 mm ² ; 2-pole; 2,50 mm ² ; gray	www.wago.com/2022-102/132-000
	Item no.: 2022-102/142-000 1-conductor female plug; Strain relief plate; 2.5 mm ² ; 2-pole; 2,50 mm ² ; gray	www.wago.com/2022-102/142-000
	Item no.: 2022-103 1-conductor female plug; 2.5 mm ² ; 3-pole; 2,50 mm ² ; gray	www.wago.com/2022-103
	Item no.: 2022-103/000-006 1-conductor female plug; 2.5 mm ² ; 3-pole; 2,50 mm ² ; blue	www.wago.com/2022-103/000-006
	Item no.: 2022-103/000-016 1-conductor female plug; 2.5 mm ² ; 3-pole; 2,50 mm ² ; green-yellow	www.wago.com/2022-103/000-016
	Item no.: 2022-103/000-036 1-conductor female plug; 2.5 mm ² ; 3-pole; 2,50 mm ² ; gray, green-yellow	www.wago.com/2022-103/000-036











Subject to changes. Please also observe the further product documentation!

	<p>Item no.: 2022-103/000-037 1-conductor female plug; 2.5 mm²; 3-pole; 2,50 mm²; green-yellow, gray</p>	<p>www.wago.com/2022-103/000-037</p>
	<p>Item no.: 2022-103/000-038 1-conductor female plug; 2.5 mm²; 3-pole; 2,50 mm²; gray, blue, green-yellow</p>	<p>www.wago.com/2022-103/000-038</p>
	<p>Item no.: 2022-103/000-039 1-conductor female plug; 2.5 mm²; 3-pole; 2,50 mm²; green-yellow, blue, gray</p>	<p>www.wago.com/2022-103/000-039</p>
	<p>Item no.: 2022-103/123-000 1-conductor female plug; Locking lever; 2.5 mm²; 3-pole; 2,50 mm²; gray</p>	<p>www.wago.com/2022-103/123-000</p>
	<p>Item no.: 2022-103/133-000 1-conductor female plug; Strain relief plate; 2.5 mm²; 3-pole; 2,50 mm²; gray</p>	<p>www.wago.com/2022-103/133-000</p>
	<p>Item no.: 2022-103/143-000 1-conductor female plug; Strain relief plate; 2.5 mm²; 3-pole; 2,50 mm²; gray</p>	<p>www.wago.com/2022-103/143-000</p>
	<p>Item no.: 2022-104 1-conductor female plug; 2.5 mm²; 4-pole; 2,50 mm²; gray</p>	<p>www.wago.com/2022-104</p>
	<p>Item no.: 2022-104/000-006 1-conductor female plug; 2.5 mm²; 4-pole; 2,50 mm²; blue</p>	<p>www.wago.com/2022-104/000-006</p>
	<p>Item no.: 2022-104/000-016 1-conductor female plug; 2.5 mm²; 4-pole; 2,50 mm²; green-yellow</p>	<p>www.wago.com/2022-104/000-016</p>
	<p>Item no.: 2022-104/000-036 1-conductor female plug; 2.5 mm²; 4-pole; 2,50 mm²; gray, green-yellow</p>	<p>www.wago.com/2022-104/000-036</p>
	<p>Item no.: 2022-104/000-037 1-conductor female plug; 2.5 mm²; 4-pole; 2,50 mm²; green-yellow, gray</p>	<p>www.wago.com/2022-104/000-037</p>
	<p>Item no.: 2022-104/000-038 1-conductor female plug; 2.5 mm²; 4-pole; 2,50 mm²; gray, blue, green-yellow</p>	<p>www.wago.com/2022-104/000-038</p>
	<p>Item no.: 2022-104/000-039 1-conductor female plug; 2.5 mm²; 4-pole; 2,50 mm²; green-yellow, blue, gray</p>	<p>www.wago.com/2022-104/000-039</p>
	<p>Item no.: 2022-104/123-000 1-conductor female plug; Locking lever; 2.5 mm²; 4-pole; 2,50 mm²; gray</p>	<p>www.wago.com/2022-104/123-000</p>

Subject to changes. Please also observe the further product documentation!

	Item no.: 2022-104/133-000 1-conductor female plug; Strain relief plate; 2.5 mm ² ; 4-pole; 2,50 mm ² ; gray	www.wago.com/2022-104/133-000
	Item no.: 2022-104/143-000 1-conductor female plug; Strain relief plate; 2.5 mm ² ; 4-pole; 2,50 mm ² ; gray	www.wago.com/2022-104/143-000
	Item no.: 2022-105 1-conductor female plug; 2.5 mm ² ; 5-pole; 2,50 mm ² ; gray	www.wago.com/2022-105
	Item no.: 2022-105/000-006 1-conductor female plug; 2.5 mm ² ; 5-pole; 2,50 mm ² ; blue	www.wago.com/2022-105/000-006
	Item no.: 2022-105/000-016 1-conductor female plug; 2.5 mm ² ; 5-pole; 2,50 mm ² ; green-yellow	www.wago.com/2022-105/000-016
	Item no.: 2022-105/000-036 1-conductor female plug; 2.5 mm ² ; 5-pole; 2,50 mm ² ; gray, green-yellow	www.wago.com/2022-105/000-036
	Item no.: 2022-105/000-037 1-conductor female plug; 2.5 mm ² ; 5-pole; 2,50 mm ² ; green-yellow, gray	www.wago.com/2022-105/000-037
	Item no.: 2022-105/000-038 1-conductor female plug; 2.5 mm ² ; 5-pole; 2,50 mm ² ; gray, blue, green-yellow	www.wago.com/2022-105/000-038
	Item no.: 2022-105/000-039 1-conductor female plug; 2.5 mm ² ; 5-pole; 2,50 mm ² ; green-yellow, blue, gray	www.wago.com/2022-105/000-039
	Item no.: 2022-105/123-000 1-conductor female plug; Locking lever; 2.5 mm ² ; 5-pole; 2,50 mm ² ; gray	www.wago.com/2022-105/123-000
	Item no.: 2022-105/134-000 1-conductor female plug; Strain relief plate; 2.5 mm ² ; 5-pole; 2,50 mm ² ; gray	www.wago.com/2022-105/134-000
	Item no.: 2022-105/144-000 1-conductor female plug; Strain relief plate; 2.5 mm ² ; 5-pole; 2,50 mm ² ; gray	www.wago.com/2022-105/144-000
	Item no.: 2022-106 1-conductor female plug; 2.5 mm ² ; 6-pole; 2,50 mm ² ; gray	www.wago.com/2022-106
	Item no.: 2022-106/000-006 1-conductor female plug; 2.5 mm ² ; 6-pole; 2,50 mm ² ; blue	www.wago.com/2022-106/000-006

Subject to changes. Please also observe the further product documentation!

	Item no.: 2022-106/000-016 1-conductor female plug; 2.5 mm ² ; 6-pole; 2,50 mm ² ; green-yellow	www.wago.com/2022-106/000-016
	Item no.: 2022-106/000-036 1-conductor female plug; 2.5 mm ² ; 6-pole; 2,50 mm ² ; gray, green-yellow	www.wago.com/2022-106/000-036
	Item no.: 2022-106/000-037 1-conductor female plug; 2.5 mm ² ; 6-pole; 2,50 mm ² ; green-yellow, gray	www.wago.com/2022-106/000-037
	Item no.: 2022-106/000-038 1-conductor female plug; 2.5 mm ² ; 6-pole; 2,50 mm ² ; gray, blue, green-yellow	www.wago.com/2022-106/000-038
	Item no.: 2022-106/000-039 1-conductor female plug; 2.5 mm ² ; 6-pole; 2,50 mm ² ; green-yellow, blue, gray	www.wago.com/2022-106/000-039
	Item no.: 2022-106/123-000 1-conductor female plug; Locking lever; 2.5 mm ² ; 6-pole; 2,50 mm ² ; gray	www.wago.com/2022-106/123-000
	Item no.: 2022-106/134-000 1-conductor female plug; Strain relief plate; 2.5 mm ² ; 6-pole; 2,50 mm ² ; gray	www.wago.com/2022-106/134-000
	Item no.: 2022-106/144-000 1-conductor female plug; Strain relief plate; 2.5 mm ² ; 6-pole; 2,50 mm ² ; gray	www.wago.com/2022-106/144-000
	Item no.: 2022-107 1-conductor female plug; 2.5 mm ² ; 7-pole; 2,50 mm ² ; gray	www.wago.com/2022-107
	Item no.: 2022-107/000-006 1-conductor female plug; 2.5 mm ² ; 7-pole; 2,50 mm ² ; blue	www.wago.com/2022-107/000-006
	Item no.: 2022-107/000-016 1-conductor female plug; 2.5 mm ² ; 7-pole; 2,50 mm ² ; green-yellow	www.wago.com/2022-107/000-016
	Item no.: 2022-107/000-036 1-conductor female plug; 2.5 mm ² ; 7-pole; 2,50 mm ² ; gray, green-yellow	www.wago.com/2022-107/000-036
	Item no.: 2022-107/000-037 1-conductor female plug; 2.5 mm ² ; 7-pole; 2,50 mm ² ; green-yellow, gray	www.wago.com/2022-107/000-037

Subject to changes. Please also observe the further product documentation!



Item no.: 2022-107/000-038

1-conductor female plug; 2.5 mm²; 7-pole; 2,50 mm²; gray, blue, green-yellow

www.wago.com/2022-107/000-038



Item no.: 2022-107/000-039

1-conductor female plug; 2.5 mm²; 7-pole; 2,50 mm²; green-yellow, blue, gray

www.wago.com/2022-107/000-039

Item no.: 2022-107/123-000

1-conductor female plug; Locking lever; 2.5 mm²; 7-pole; 2,50 mm²; gray

www.wago.com/2022-107/123-000

Item no.: 2022-107/135-000

1-conductor female plug; Strain relief plate; 2.5 mm²; 7-pole; 2,50 mm²; gray

www.wago.com/2022-107/135-000

Item no.: 2022-107/145-000

1-conductor female plug; Strain relief plate; 2.5 mm²; 7-pole; 2,50 mm²; gray

www.wago.com/2022-107/145-000



Item no.: 2022-108

1-conductor female plug; 2.5 mm²; 8-pole; 2,50 mm²; gray

www.wago.com/2022-108



Item no.: 2022-108/000-006

1-conductor female plug; 2.5 mm²; 8-pole; 2,50 mm²; blue

www.wago.com/2022-108/000-006



Item no.: 2022-108/000-016

1-conductor female plug; 2.5 mm²; 8-pole; 2,50 mm²; green-yellow

www.wago.com/2022-108/000-016



Item no.: 2022-108/000-036

1-conductor female plug; 2.5 mm²; 8-pole; 2,50 mm²; gray, green-yellow

www.wago.com/2022-108/000-036



Item no.: 2022-108/000-037

1-conductor female plug; 2.5 mm²; 8-pole; 2,50 mm²; green-yellow, gray

www.wago.com/2022-108/000-037



Item no.: 2022-108/000-038

1-conductor female plug; 2.5 mm²; 8-pole; 2,50 mm²; gray, blue, green-yellow

www.wago.com/2022-108/000-038



Item no.: 2022-108/000-039

1-conductor female plug; 2.5 mm²; 8-pole; 2,50 mm²; green-yellow, blue, gray

www.wago.com/2022-108/000-039

Item no.: 2022-108/123-000

1-conductor female plug; Locking lever; 2.5 mm²; 8-pole; 2,50 mm²; gray

www.wago.com/2022-108/123-000

Subject to changes. Please also observe the further product documentation!

WAGO Kontakttechnik GmbH & Co. KG

Hansastr. 27









32423 Minden

Phone: +49571 887-0 | Fax: +49571 887-169











Email: info.de@wago.com | Web: www.wago.com

Do you have any questions about our products?

We are always happy to take your call at +49 (571) 887-44222.

	<p>Item no.: 2022-108/135-000 1-conductor female plug; Strain relief plate; 2.5 mm²; 8-pole; 2,50 mm²; gray</p>	<p>www.wago.com/2022-108/135-000</p>
	<p>Item no.: 2022-108/145-000 1-conductor female plug; Strain relief plate; 2.5 mm²; 8-pole; 2,50 mm²; gray</p>	<p>www.wago.com/2022-108/145-000</p>
	<p>Item no.: 2022-109 1-conductor female plug; 2.5 mm²; 9-pole; 2,50 mm²; gray</p>	<p>www.wago.com/2022-109</p>
	<p>Item no.: 2022-109/000-006 1-conductor female plug; 2.5 mm²; 9-pole; 2,50 mm²; blue</p>	<p>www.wago.com/2022-109/000-006</p>
	<p>Item no.: 2022-109/000-016 1-conductor female plug; 2.5 mm²; 9-pole; 2,50 mm²; green-yellow</p>	<p>www.wago.com/2022-109/000-016</p>
	<p>Item no.: 2022-109/000-036 1-conductor female plug; 2.5 mm²; 9-pole; 2,50 mm²; gray, green-yellow</p>	<p>www.wago.com/2022-109/000-036</p>
	<p>Item no.: 2022-109/000-037 1-conductor female plug; 2.5 mm²; 9-pole; 2,50 mm²; green-yellow, gray</p>	<p>www.wago.com/2022-109/000-037</p>
	<p>Item no.: 2022-109/000-038 1-conductor female plug; 2.5 mm²; 9-pole; 2,50 mm²; gray, blue, green-yellow</p>	<p>www.wago.com/2022-109/000-038</p>
	<p>Item no.: 2022-109/000-039 1-conductor female plug; 2.5 mm²; 9-pole; 2,50 mm²; green-yellow, blue, gray</p>	<p>www.wago.com/2022-109/000-039</p>
	<p>Item no.: 2022-109/123-000 1-conductor female plug; Locking lever; 2.5 mm²; 9-pole; 2,50 mm²; gray</p>	<p>www.wago.com/2022-109/123-000</p>
	<p>Item no.: 2022-109/135-000 1-conductor female plug; Strain relief plate; 2.5 mm²; 9-pole; 2,50 mm²; gray</p>	<p>www.wago.com/2022-109/135-000</p>
	<p>Item no.: 2022-109/145-000 1-conductor female plug; Strain relief plate; 2.5 mm²; 9-pole; 2,50 mm²; gray</p>	<p>www.wago.com/2022-109/145-000</p>
	<p>Item no.: 2022-110 1-conductor female plug; 2.5 mm²; 10-pole; 2,50 mm²; gray</p>	<p>www.wago.com/2022-110</p>
	<p>Item no.: 2022-110/000-006 1-conductor female plug; 2.5 mm²; 10-pole; 2,50 mm²; blue</p>	<p>www.wago.com/2022-110/000-006</p>

Subject to changes. Please also observe the further product documentation!

	Item no.: 2022-110/000-016 1-conductor female plug; 2.5 mm ² ; 10-pole; 2,50 mm ² ; green-yellow	www.wago.com/2022-110/000-016
	Item no.: 2022-110/000-036 1-conductor female plug; 2.5 mm ² ; 10-pole; 2,50 mm ² ; gray, green-yellow	www.wago.com/2022-110/000-036
	Item no.: 2022-110/000-037 1-conductor female plug; 2.5 mm ² ; 10-pole; 2,50 mm ² ; green-yellow, gray	www.wago.com/2022-110/000-037
	Item no.: 2022-110/000-038 1-conductor female plug; 2.5 mm ² ; 10-pole; 2,50 mm ² ; gray, blue, green-yellow	www.wago.com/2022-110/000-038
	Item no.: 2022-110/000-039 1-conductor female plug; 2.5 mm ² ; 10-pole; 2,50 mm ² ; green-yellow, blue, gray	www.wago.com/2022-110/000-039
	Item no.: 2022-110/123-000 1-conductor female plug; Locking lever; 2.5 mm ² ; 10-pole; 2,50 mm ² ; gray	www.wago.com/2022-110/123-000
	Item no.: 2022-110/135-000 1-conductor female plug; Strain relief plate; 2.5 mm ² ; 10-pole; 2,50 mm ² ; gray	www.wago.com/2022-110/135-000
	Item no.: 2022-110/145-000 1-conductor female plug; Strain relief plate; 2.5 mm ² ; 10-pole; 2,50 mm ² ; gray	www.wago.com/2022-110/145-000
	Item no.: 2022-111 1-conductor female plug; 2.5 mm ² ; 11-pole; 2,50 mm ² ; gray	www.wago.com/2022-111
	Item no.: 2022-111/000-006 1-conductor female plug; 2.5 mm ² ; 11-pole; 2,50 mm ² ; blue	www.wago.com/2022-111/000-006
	Item no.: 2022-111/000-016 1-conductor female plug; 2.5 mm ² ; 11-pole; 2,50 mm ² ; green-yellow	www.wago.com/2022-111/000-016
	Item no.: 2022-111/000-036 1-conductor female plug; 2.5 mm ² ; 11-pole; 2,50 mm ² ; gray, green-yellow	www.wago.com/2022-111/000-036
	Item no.: 2022-111/000-037 1-conductor female plug; 2.5 mm ² ; 11-pole; 2,50 mm ² ; green-yellow, gray	www.wago.com/2022-111/000-037

Subject to changes. Please also observe the further product documentation!



Item no.: 2022-111/000-038

1-conductor female plug; 2.5 mm²; 11-pole; 2,50 mm²; gray, blue, green-yellow

www.wago.com/2022-111/000-038



Item no.: 2022-111/000-039

1-conductor female plug; 2.5 mm²; 11-pole; 2,50 mm²; green-yellow, blue, gray

www.wago.com/2022-111/000-039

Item no.: 2022-111/126-000

1-conductor female plug; Locking lever; 2.5 mm²; 11-pole; 2,50 mm²; gray

www.wago.com/2022-111/126-000

Item no.: 2022-111/136-000

1-conductor female plug; Strain relief plate; 2.5 mm²; 11-pole; 2,50 mm²; gray

www.wago.com/2022-111/136-000

Item no.: 2022-111/146-000

1-conductor female plug; Strain relief plate; 2.5 mm²; 11-pole; 2,50 mm²; gray

www.wago.com/2022-111/146-000



Item no.: 2022-112

1-conductor female plug; 2.5 mm²; 12-pole; 2,50 mm²; gray

www.wago.com/2022-112



Item no.: 2022-112/000-006

1-conductor female plug; 2.5 mm²; 12-pole; 2,50 mm²; blue

www.wago.com/2022-112/000-006



Item no.: 2022-112/000-016

1-conductor female plug; 2.5 mm²; 12-pole; 2,50 mm²; green-yellow

www.wago.com/2022-112/000-016



Item no.: 2022-112/000-036

1-conductor female plug; 2.5 mm²; 12-pole; 2,50 mm²; gray, green-yellow

www.wago.com/2022-112/000-036



Item no.: 2022-112/000-037

1-conductor female plug; 2.5 mm²; 12-pole; 2,50 mm²; green-yellow, gray

www.wago.com/2022-112/000-037



Item no.: 2022-112/000-038

1-conductor female plug; 2.5 mm²; 12-pole; 2,50 mm²; gray, blue, green-yellow

www.wago.com/2022-112/000-038



Item no.: 2022-112/000-039

1-conductor female plug; 2.5 mm²; 12-pole; 2,50 mm²; green-yellow, blue, gray

www.wago.com/2022-112/000-039

Item no.: 2022-112/126-000

1-conductor female plug; Locking lever; 2.5 mm²; 12-pole; 2,50 mm²; gray

www.wago.com/2022-112/126-000

Subject to changes. Please also observe the further product documentation!

WAGO Kontakttechnik GmbH & Co. KG

Hansastr. 27









32423 Minden

Phone: +49571 887-0 | Fax: +49571 887-169











Email: info.de@wago.com | Web: www.wago.com

Do you have any questions about our products?

We are always happy to take your call at +49 (571) 887-44222.

	<p>Item no.: 2022-112/136-000 1-conductor female plug; Strain relief plate; 2.5 mm²; 12-pole; 2,50 mm²; gray</p>	<p>www.wago.com/2022-112/136-000</p>
	<p>Item no.: 2022-112/146-000 1-conductor female plug; Strain relief plate; 2.5 mm²; 12-pole; 2,50 mm²; gray</p>	<p>www.wago.com/2022-112/146-000</p>
	<p>Item no.: 2022-113 1-conductor female plug; 2.5 mm²; 13-pole; 2,50 mm²; gray</p>	<p>www.wago.com/2022-113</p>
	<p>Item no.: 2022-113/000-006 1-conductor female plug; 2.5 mm²; 13-pole; 2,50 mm²; blue</p>	<p>www.wago.com/2022-113/000-006</p>
	<p>Item no.: 2022-113/000-016 1-conductor female plug; 2.5 mm²; 13-pole; 2,50 mm²; green-yellow</p>	<p>www.wago.com/2022-113/000-016</p>
	<p>Item no.: 2022-113/000-036 1-conductor female plug; 2.5 mm²; 13-pole; 2,50 mm²; gray, green-yellow</p>	<p>www.wago.com/2022-113/000-036</p>
	<p>Item no.: 2022-113/000-037 1-conductor female plug; 2.5 mm²; 13-pole; 2,50 mm²; green-yellow, gray</p>	<p>www.wago.com/2022-113/000-037</p>
	<p>Item no.: 2022-113/000-038 1-conductor female plug; 2.5 mm²; 13-pole; 2,50 mm²; gray, blue, green-yellow</p>	<p>www.wago.com/2022-113/000-038</p>
	<p>Item no.: 2022-113/000-039 1-conductor female plug; 2.5 mm²; 13-pole; 2,50 mm²; green-yellow, blue, gray</p>	<p>www.wago.com/2022-113/000-039</p>
	<p>Item no.: 2022-113/126-000 1-conductor female plug; Locking lever; 2.5 mm²; 13-pole; 2,50 mm²; gray</p>	<p>www.wago.com/2022-113/126-000</p>
	<p>Item no.: 2022-113/136-000 1-conductor female plug; Strain relief plate; 2.5 mm²; 13-pole; 2,50 mm²; gray</p>	<p>www.wago.com/2022-113/136-000</p>
	<p>Item no.: 2022-113/146-000 1-conductor female plug; Strain relief plate; 2.5 mm²; 13-pole; 2,50 mm²; gray</p>	<p>www.wago.com/2022-113/146-000</p>
	<p>Item no.: 2022-114 1-conductor female plug; 2.5 mm²; 14-pole; 2,50 mm²; gray</p>	<p>www.wago.com/2022-114</p>
	<p>Item no.: 2022-114/000-006 1-conductor female plug; 2.5 mm²; 14-pole; 2,50 mm²; blue</p>	<p>www.wago.com/2022-114/000-006</p>

Subject to changes. Please also observe the further product documentation!

	<p>Item no.: 2022-114/000-016 1-conductor female plug; 2.5 mm²; 14-pole; 2,50 mm²; green-yellow</p>	www.wago.com/2022-114/000-016
	<p>Item no.: 2022-114/000-036 1-conductor female plug; 2.5 mm²; 14-pole; 2,50 mm²; gray, green-yellow</p>	www.wago.com/2022-114/000-036
	<p>Item no.: 2022-114/000-037 1-conductor female plug; 2.5 mm²; 14-pole; 2,50 mm²; green-yellow, gray</p>	www.wago.com/2022-114/000-037
	<p>Item no.: 2022-114/000-038 1-conductor female plug; 2.5 mm²; 14-pole; 2,50 mm²; gray, blue, green-yellow</p>	www.wago.com/2022-114/000-038
	<p>Item no.: 2022-114/000-039 1-conductor female plug; 2.5 mm²; 14-pole; 2,50 mm²; green-yellow, blue, gray</p>	www.wago.com/2022-114/000-039
	<p>Item no.: 2022-114/126-000 1-conductor female plug; Locking lever; 2.5 mm²; 14-pole; 2,50 mm²; gray</p>	www.wago.com/2022-114/126-000
	<p>Item no.: 2022-114/136-000 1-conductor female plug; Strain relief plate; 2.5 mm²; 14-pole; 2,50 mm²; gray</p>	www.wago.com/2022-114/136-000
	<p>Item no.: 2022-114/146-000 1-conductor female plug; Strain relief plate; 2.5 mm²; 14-pole; 2,50 mm²; gray</p>	www.wago.com/2022-114/146-000
	<p>Item no.: 2022-115 1-conductor female plug; 2.5 mm²; 15-pole; 2,50 mm²; gray</p>	www.wago.com/2022-115
	<p>Item no.: 2022-115/000-006 1-conductor female plug; 2.5 mm²; 15-pole; 2,50 mm²; blue</p>	www.wago.com/2022-115/000-006
	<p>Item no.: 2022-115/000-016 1-conductor female plug; 2.5 mm²; 15-pole; 2,50 mm²; green-yellow</p>	www.wago.com/2022-115/000-016
	<p>Item no.: 2022-115/000-036 1-conductor female plug; 2.5 mm²; 15-pole; 2,50 mm²; gray, green-yellow</p>	www.wago.com/2022-115/000-036
	<p>Item no.: 2022-115/000-037 1-conductor female plug; 2.5 mm²; 15-pole; 2,50 mm²; green-yellow, gray</p>	www.wago.com/2022-115/000-037

Subject to changes. Please also observe the further product documentation!



Item no.: 2022-115/000-038
1-conductor female plug; 2.5 mm²; 15-pole; 2,50 mm²; gray, blue, green-yellow

www.wago.com/2022-115/000-038



Item no.: 2022-115/000-039
1-conductor female plug; 2.5 mm²; 15-pole; 2,50 mm²; green-yellow, blue, gray

www.wago.com/2022-115/000-039

Item no.: 2022-115/127-000
1-conductor female plug; Locking lever; 2.5 mm²; 15-pole; 2,50 mm²; gray

www.wago.com/2022-115/127-000

Item no.: 2022-115/137-000
1-conductor female plug; Strain relief plate; 2.5 mm²; 15-pole; 2,50 mm²; gray

www.wago.com/2022-115/137-000

Item no.: 2022-115/147-000
1-conductor female plug; Strain relief plate; 2.5 mm²; 15-pole; 2,50 mm²; gray

www.wago.com/2022-115/147-000

General accessories

Item no.: 2022-161
Start module for 1-conductor female connector; with integrated end plate; 2.5 mm²; 1-pole; 2,50 mm²; gray

www.wago.com/2022-161



Item no.: 2022-162
Start module for 1-conductor female connector; with integrated end plate; 2.5 mm²; 1-pole; 2,50 mm²; orange

www.wago.com/2022-162



Item no.: 2022-164
Start module for 1-conductor female connector; with integrated end plate; 2.5 mm²; 1-pole; 2,50 mm²; blue

www.wago.com/2022-164

Item no.: 2022-167
Start module for 1-conductor female connector; with integrated end plate; 2.5 mm²; 1-pole; 2,50 mm²; green-yellow

www.wago.com/2022-167



Item no.: 2022-171
Center module for 1-conductor female connector; 2.5 mm²; 1-pole; 2,50 mm²; gray

www.wago.com/2022-171



Item no.: 2022-172
Center module for 1-conductor female connector; 2.5 mm²; 1-pole; 2,50 mm²; orange

www.wago.com/2022-172



Item no.: 2022-174
Center module for 1-conductor female connector; 2.5 mm²; 1-pole; 2,50 mm²; blue

www.wago.com/2022-174



Item no.: 2022-177
Center module for 1-conductor female connector; 2.5 mm²; 1-pole; 2,50 mm²; green-yellow

www.wago.com/2022-177



Item no.: 2022-181
End module for 1-conductor female connector; 2.5 mm²; 1-pole; 2,50 mm²; gray

www.wago.com/2022-181

Item no.: 2022-182
End module for 1-conductor female connector; 2.5 mm²; 1-pole; 2,50 mm²; orange

www.wago.com/2022-182

Subject to changes. Please also observe the further product documentation!



Item no.: 2022-184
End module for 1-conductor female connector; 2.5 mm²; 1-pole; 2,50 mm²; blue

www.wago.com/2022-184



Item no.: 2022-187
End module for 1-conductor female connector; 2.5 mm²; 1-pole; 2,50 mm²; green-yellow

www.wago.com/2022-187

Insulation stop

Item no.: 2002-171
Insulation stop; 0.25 - 0.5 mm²; 5 pieces/strip; light gray

www.wago.com/2002-171

Item no.: 2002-172
Insulation stop; 0.75 - 1 mm²; 5 pieces/strip; dark gray

www.wago.com/2002-172

Coding



Item no.: 2022-100
Carrier with 6 coding pins; for coding of female plugs; orange

www.wago.com/2022-100

Carrier rail

Item no.: 210-112
Steel carrier rail; 35 x 7.5 mm; 1 mm thick; 2 m long; slotted; according to EN 60715; "Hole width 25 mm

www.wago.com/210-112



Item no.: 210-113
Steel carrier rail; 35 x 7.5 mm; 1 mm thick; 2 m long; unslotted; according to EN 60715

www.wago.com/210-113

Item no.: 210-114
Steel carrier rail; 35 x 15 mm; 1.5 mm thick; 2 m long; unslotted; similar to EN 60715

www.wago.com/210-114

Item no.: 210-115
Steel carrier rail; 35 x 7.5 mm; 1 mm thick; 2 m long; slotted; according to EN 60715; "Hole width 18 mm

www.wago.com/210-115

Item no.: 210-118
Steel carrier rail; 35 x 15 mm; 2.3 mm thick; 2 m long; unslotted; according to EN 60715

www.wago.com/210-118



Item no.: 210-196
Aluminum carrier rail; 35 x 8.2 mm; 1.6 mm thick; 2 m long; unslotted; similar to EN 60715; silver-colored

www.wago.com/210-196

Item no.: 210-197
Steel carrier rail; 35 x 15 mm; 1.5 mm thick; 2 m long; slotted; similar to EN 60715

www.wago.com/210-197

Item no.: 210-198
Copper carrier rail; 35 x 15 mm; 2.3 mm thick; 2 m long; unslotted; according to EN 60715; copper-colored

www.wago.com/210-198



Item no.: 210-504
Steel carrier rail; 35 x 7.5 mm; 1 mm thick; 2 m long; slotted; galvanized; according to EN 60715

www.wago.com/210-504



Item no.: 210-505
Steel carrier rail; 35 x 7.5 mm; 1 mm thick; 2 m long; unslotted; galvanized; according to EN 60715

www.wago.com/210-505



Item no.: 210-506
Steel carrier rail; 35 x 15 mm; 1.5 mm thick; 2 m long; unslotted; galvanized; similar to EN 60715

www.wago.com/210-506

Subject to changes. Please also observe the further product documentation!

WAGO Kontakttechnik GmbH & Co. KG

Hansastr. 27

32423 Minden

Phone: +49571 887-0 | Fax: +49571 887-169

Email: info.de@wago.com | Web: www.wago.com

Do you have any questions about our products?

We are always happy to take your call at +49 (571) 887-44222.



Item no.: 210-508

Steel carrier rail; 35 x 15 mm; 1.5 mm thick; 2 m long; slotted; galvanized; similar to EN 60715

www.wago.com/210-508

End plate



Item no.: 2022-2291

End and intermediate plate; 1 mm thick; gray

www.wago.com/2022-2291



Item no.: 2022-2292

End and intermediate plate; 1 mm thick; orange

www.wago.com/2022-2292

Test Accessories



Item no.: 2009-174

Test plug adapter; for 4 mm Ø test plugs; for testing TOPJOB®S rail-mounted terminal blocks; gray

www.wago.com/2009-174

Item no.: 2009-182

Testing tap; for max. 2.5 mm²; tool-free connection for individual test wires 0.08 - 2.5 mm; gray

www.wago.com/2009-182

Downloads

Documentation

Additional Information

Technical explanations

Apr 3, 2019

pdf
2.1 MB

Download

CAD/CAE-Data

CAD data

2D/3D Models 2022-2201

URL

Download

CAE data

EPLAN Data Portal 2022-2201

URL

Download

WSCAD Universe 2022-2201

URL

Download

Installation Notes

Coding

Subject to changes. Please also observe the further product documentation!

WAGO Kontakttechnik GmbH & Co. KG

Hansastr. 27

32423 Minden

Phone: +49571 887-0 | Fax: +49571 887-169

Email: info.de@wago.com | Web: www.wago.com

Do you have any questions about our products?

We are always happy to take your call at +49 (571) 887-44222.

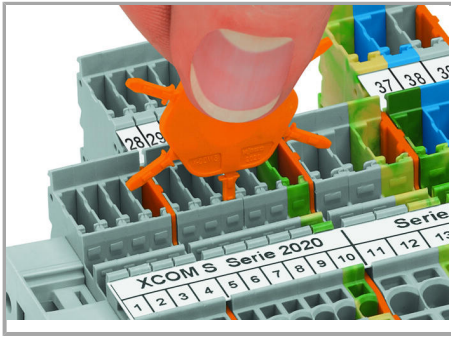

Insert coding pin into the corresponding slot and twist it off.



Coding a female plug: remove coding finger using a suitable tool.

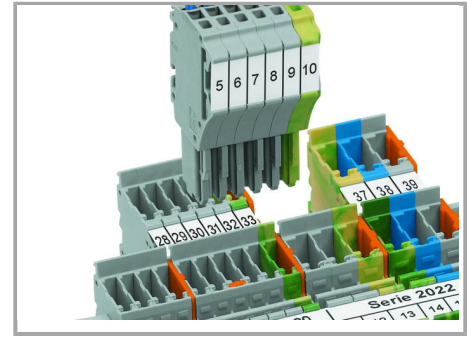

Insert coded female connector into X-COM®S-SYSTEM terminal block assembly.

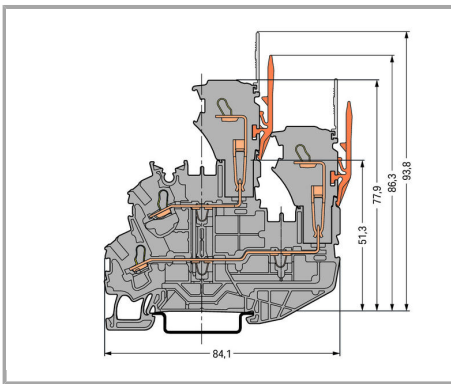

Double-deck carrier terminal block

Subject to changes. Please also observe the further product documentation!

WAGO Kontakttechnik GmbH & Co. KG
Hansastr. 27
32423 Minden
Phone: +49571 887-0 | Fax: +49571 887-169
Email: info.de@wago.com | Web: www.wago.com

Do you have any questions about our products?
We are always happy to take your call at +49 (571) 887-44222.

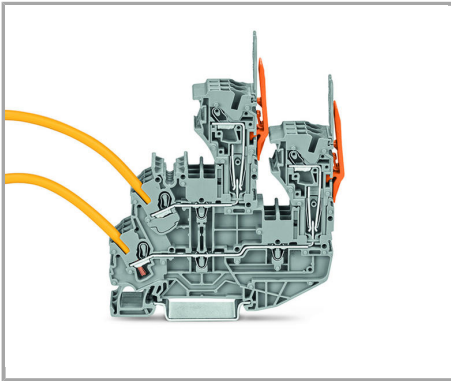

1-conductor female plug

Double-deck carrier terminal blocks can be commoned via 2002 Series Push-In Type Jumper Bars and tested via 859-500 Test Pin.

Marking

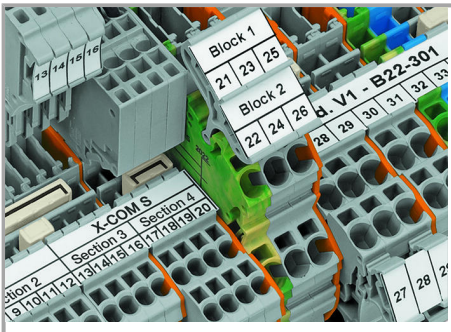

Clear marking via large marking area

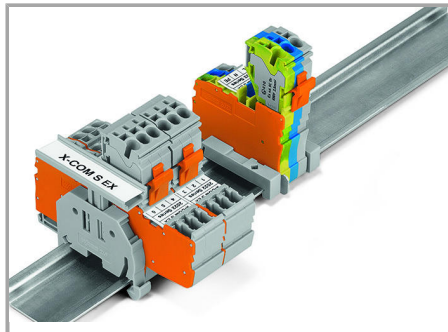

Group marking with height-adjustable group marker carrier (2009 163)

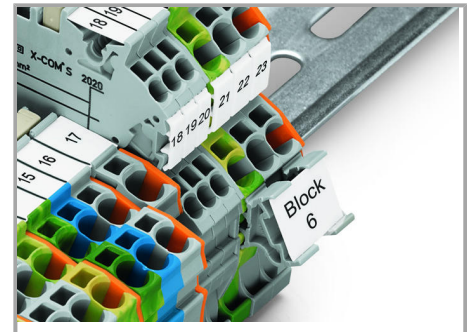

Marker carrier (2009-198)

Product family

X-COM S

[Show all products from the family](#)

Subject to changes. Please also observe the further product documentation!