

Data sheet | Item number: 2022-1201

1-conductor/1-pin carrier terminal block; for DIN-rail 35 x 15 and 35 x 7.5;
2.5 mm²; Push-in CAGE CLAMP®; 2,50 mm²; gray

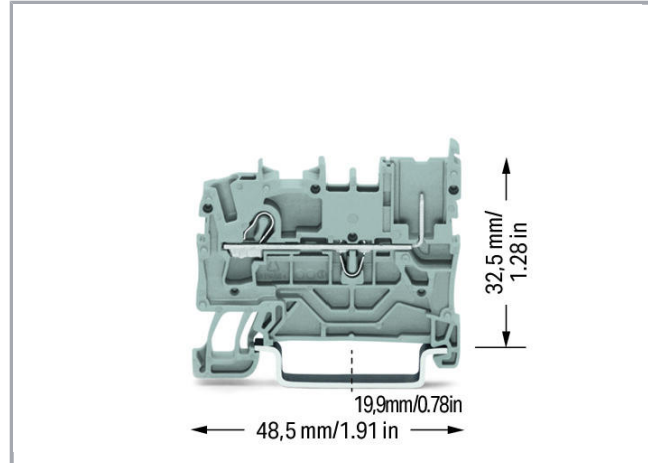

www.wago.com/2022-1201

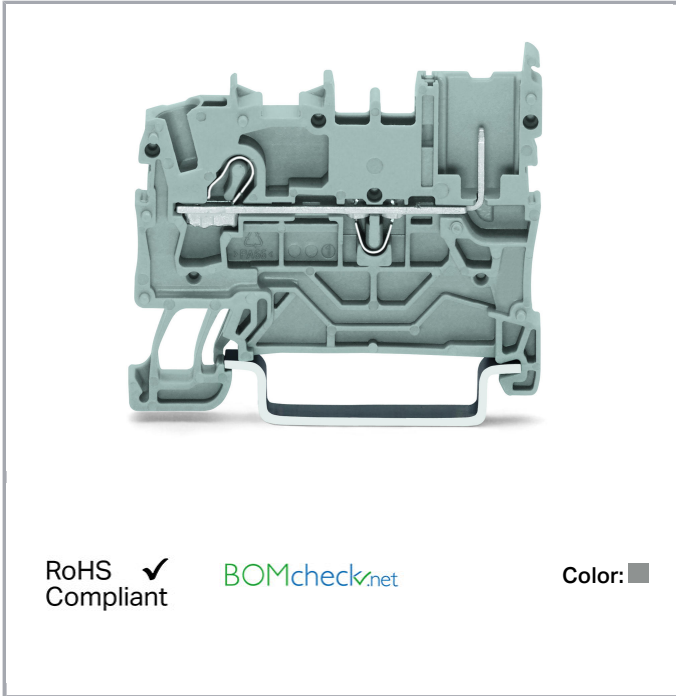

RoHS Compliant

[BOMcheck.net](https://www.bomcheck.net)

Color:

Data

Electrical data

Ratings per IEC/EN 60664-1

Ratings per	IEC/EN 60947-7-1
Rated voltage (III / 3)	690 V
Rated impulse voltage (III / 3)	6 kV
Rated current	24 A
Rated current (2)	32 A
Legend (ratings)	(III / 3) ≙ Overvoltage category III / Pollution degree 3

Connection data

Connection technology	Push-in CAGE CLAMP®
Actuation type	Open Tool Slot Push-in

Subject to changes. Please also observe the further product documentation!

WAGO Kontakttechnik GmbH & Co. KG
Hansastr. 27
32423 Minden
Phone: +49571 887-0 | Fax: +49571 887-169
Email: info.de@wago.com | Web: www.wago.com

Do you have any questions about our products?
We are always happy to take your call at +49 (571) 887-44222.



Connectable conductor materials	Copper
Nominal cross section	2.5 mm ²
Solid conductor	0.25 ... 4 mm ² / 22 ... 12 AWG
Solid conductor, push-in termination	0.75 ... 4 mm ² / 18 ... 12 AWG
Fine-stranded conductor	0.25 ... 4 mm ² / 22 ... 12 AWG
Fine-stranded conductor with ferrule with plastic collar	1 ... 2.5 mm ² / 18 ... 12 AWG
Fine-stranded conductor with ferrule, push-in termination, from	1 ... 2.5 mm ² / 18 ... 12 AWG
Strip length	10 ... 12 mm / 0.39 ... 0.47 inch
Total number of connection points	1
Total number of potentials	1
Number of levels	1
Type of wiring	Front-entry wiring
Note (conductor cross-section)	Depending on the conductor characteristic, a conductor with a smaller cross section can also be inserted via push-in termination.

Geometrical Data

Width	5.2 mm / 0.205 inch
Height from upper-edge of DIN-35 rail	32.5 mm / 1.28 inch
Depth	48.5 mm / 1.909 inch

Mechanical data

Design	horizontal
Type of mounting	DIN-35 rail
Marking level	Center/side marking

Material Data

Color	gray
Insulating material	Polyamide 66 (PA 66)
Fire load	0.112 MJ
Weight	5 g

Commercial data

Product Group	18 (X-COM-System)
Packaging type	BOX
Country of origin	CN
GTIN	4050821145059
Customs Tariff No.	85366990990



Subject to changes. Please also observe the further product documentation!

WAGO Kontakttechnik GmbH & Co. KG
 Hansastr. 27
 32423 Minden
 Phone: +49571 887-0 | Fax: +49571 887-169
 Email: info.de@wago.com | Web: www.wago.com

Do you have any questions about our products?
 We are always happy to take your call at +49 (571) 887-44222.

Approvals / Certificates

Country specific Approvals

Logo	Approval	Additional Approval Text	Certificate name
	CCA DEKRA Certification B.V.	EN 60947	NTR NL 7628
	CSA DEKRA Certification B.V.	C22.2 No. 158	2437422

UL-Approvals

Logo	Approval	Additional Approval Text	Certificate name
	UR Underwriters Laboratories Inc.	UL 1059	E45172

Counterpart

Compatible products

Marking accessories



Item no.: 2002-161
Adaptor

www.wago.com/2002-161

Item no.: 2009-110

Subject to changes. Please also observe the further product documentation!

Marking strips; on reel; not stretchable; plain; snap-on type; white

www.wago.com/2009-110**Item no.: 2009-115**

WMB-Inline; for Smart Printer; 1500 pieces on roll; stretchable 5 - 5.2 mm; plain; snap-on type; white

www.wago.com/2009-115**Item no.: 2009-115/000-002**

WMB-Inline; for Smart Printer; 1500 pieces on roll; stretchable 5 - 5.2 mm; plain; snap-on type; yellow

www.wago.com/2009-115/000-002**Item no.: 2009-115/000-005**

WMB-Inline; for Smart Printer; 1500 pieces on roll; stretchable 5 - 5.2 mm; plain; snap-on type; white

www.wago.com/2009-115/000-005**Item no.: 2009-115/000-006**

WMB-Inline; for Smart Printer; 1500 pieces on roll; stretchable 5 - 5.2 mm; plain; snap-on type; white

www.wago.com/2009-115/000-006**Item no.: 2009-115/000-007**

WMB-Inline; for Smart Printer; 1500 pieces on roll; stretchable 5 - 5.2 mm; plain; snap-on type; gray

www.wago.com/2009-115/000-007**Item no.: 2009-115/000-012**

WMB-Inline; for Smart Printer; 1500 pieces on roll; stretchable 5 - 5.2 mm; plain; snap-on type; white

www.wago.com/2009-115/000-012**Item no.: 2009-115/000-017**

WMB-Inline; for Smart Printer; 1500 pieces on roll; stretchable 5 - 5.2 mm; plain; snap-on type; white

www.wago.com/2009-115/000-017**Item no.: 2009-115/000-023**

WMB-Inline; for Smart Printer; 1500 pieces on roll; stretchable 5 - 5.2 mm; plain; snap-on type; green

www.wago.com/2009-115/000-023**Item no.: 2009-115/000-024**

WMB-Inline; for Smart Printer; 1500 pieces on roll; stretchable 5 - 5.2 mm; plain; snap-on type; white

www.wago.com/2009-115/000-024**Item no.: 2009-145**

Mini-WSB Inline; for Smart Printer; 1700 pieces on roll; stretchable 5 - 5.2 mm; plain; snap-on type; white

www.wago.com/2009-145**Item no.: 2009-145/000-002**

Mini-WSB Inline; for Smart Printer; 1700 pieces on roll; stretchable 5 - 5.2 mm; plain; snap-on type; white

www.wago.com/2009-145/000-002**Item no.: 2009-145/000-005**

Mini-WSB Inline; for Smart Printer; 1700 pieces on roll; stretchable 5 - 5.2 mm; plain; snap-on type; red

www.wago.com/2009-145/000-005**Item no.: 2009-145/000-006**

Mini-WSB Inline; for Smart Printer; 1700 pieces on roll; stretchable 5 - 5.2 mm; plain; snap-on type; blue

www.wago.com/2009-145/000-006

Subject to changes. Please also observe the further product documentation!

WAGO Kontakttechnik GmbH & Co. KG

Hansastr. 27















32423 Minden

Phone: +49571 887-0 | Fax: +49571 887-169











Email: info.de@wago.com | Web: www.wago.com

Do you have any questions about our products?

We are always happy to take your call at +49 (571) 887-44222.

	<p>Item no.: 2009-145/000-007 Mini-WSB Inline; for Smart Printer; 1700 pieces on roll; stretchable 5 - 5.2 mm; plain; snap-on type; white</p>	www.wago.com/2009-145/000-007
	<p>Item no.: 2009-145/000-012 Mini-WSB Inline; for Smart Printer; 1700 pieces on roll; stretchable 5 - 5.2 mm; plain; snap-on type; orange</p>	www.wago.com/2009-145/000-012
	<p>Item no.: 2009-145/000-023 Mini-WSB Inline; for Smart Printer; 1700 pieces on roll; stretchable 5 - 5.2 mm; plain; snap-on type; green</p>	www.wago.com/2009-145/000-023
	<p>Item no.: 2009-145/000-024 Mini-WSB Inline; for Smart Printer; 1700 pieces on roll; stretchable 5 - 5.2 mm; plain; snap-on type; violet</p>	www.wago.com/2009-145/000-024
	<p>Item no.: 2009-191 Group marker carrier</p>	www.wago.com/2009-191
	<p>Item no.: 2009-192 Group marker carrier</p>	www.wago.com/2009-192
	<p>Item no.: 2009-193 Group marker carrier</p>	www.wago.com/2009-193
	<p>Item no.: 2009-198 Adaptor</p>	www.wago.com/2009-198
	<p>Item no.: 248-501 Miniature WSB Quick marking system; plain; Marker width 5 mm; 10 strips with 10 markers per card</p>	www.wago.com/248-501
	<p>Item no.: 248-501/000-002 Mini-WSB marking card; as card; not stretchable; plain; snap-on type; yellow</p>	www.wago.com/248-501/000-002
	<p>Item no.: 248-501/000-005 Mini-WSB marking card; as card; not stretchable; plain; snap-on type; red</p>	www.wago.com/248-501/000-005
	<p>Item no.: 248-501/000-006 Mini-WSB marking card; as card; not stretchable; plain; snap-on type; blue</p>	www.wago.com/248-501/000-006
	<p>Item no.: 248-501/000-007 Mini-WSB marking card; as card; not stretchable; plain; snap-on type; gray</p>	www.wago.com/248-501/000-007
	<p>Item no.: 248-501/000-012 Mini-WSB marking card; as card; not stretchable; plain; snap-on type; orange</p>	www.wago.com/248-501/000-012
	<p>Item no.: 248-501/000-017 Mini-WSB marking card; as card; not stretchable; plain; snap-on type; light green</p>	www.wago.com/248-501/000-017

Subject to changes. Please also observe the further product documentation!

	Item no.: 248-501/000-023 Mini-WSB marking card; as card; not stretchable; plain; snap-on type; green	www.wago.com/248-501/000-023
	Item no.: 248-501/000-024 Mini-WSB marking card; as card; not stretchable; plain; snap-on type; violet	www.wago.com/248-501/000-024
	Item no.: 793-501 WMB marking card; as card; not stretchable; plain; snap-on type; white	www.wago.com/793-501
	Item no.: 793-501/000-002 WMB marking card; as card; not stretchable; plain; snap-on type; yellow	www.wago.com/793-501/000-002
	Item no.: 793-501/000-005 WMB marking card; as card; not stretchable; plain; snap-on type; red	www.wago.com/793-501/000-005
	Item no.: 793-501/000-006 WMB marking card; as card; not stretchable; plain; snap-on type; blue	www.wago.com/793-501/000-006
	Item no.: 793-501/000-007 WMB marking card; as card; not stretchable; plain; snap-on type; gray	www.wago.com/793-501/000-007
	Item no.: 793-501/000-012 WMB marking card; as card; not stretchable; plain; snap-on type; orange	www.wago.com/793-501/000-012
	Item no.: 793-501/000-017 WMB marking card; as card; not stretchable; plain; snap-on type; light green	www.wago.com/793-501/000-017
	Item no.: 793-501/000-023 WMB marking card; as card; not stretchable; plain; snap-on type; green	www.wago.com/793-501/000-023
	Item no.: 793-501/000-024 WMB marking card; as card; not stretchable; plain; snap-on type; violet	www.wago.com/793-501/000-024
	Item no.: 793-5501 WMB marking card; as card; for terminal block width 5 - 17.5 mm; stretchable 5 - 5.2 mm; plain; snap-on type; white	www.wago.com/793-5501
	Item no.: 793-5501/000-002 WMB marking card; as card; for terminal block width 5 - 17.5 mm; stretchable 5 - 5.2 mm; plain; snap-on type; yellow	www.wago.com/793-5501/000-002
	Item no.: 793-5501/000-005 WMB marking card; as card; for terminal block width 5 - 17.5 mm; stretchable 5 - 5.2 mm; plain; snap-	www.wago.com/793-5501/000-005

Subject to changes. Please also observe the further product documentation!

on type; red

Item no.: 793-5501/000-006

WMB marking card; as card; for terminal block width 5 - 17.5 mm; stretchable 5 - 5.2 mm; plain; snap-on type; blue

www.wago.com/793-5501/000-006

Item no.: 793-5501/000-007

WMB marking card; as card; for terminal block width 5 - 17.5 mm; stretchable 5 - 5.2 mm; plain; snap-on type; gray

www.wago.com/793-5501/000-007



Item no.: 793-5501/000-012

WMB marking card; as card; for terminal block width 5 - 17.5 mm; stretchable 5 - 5.2 mm; plain; snap-on type; orange

www.wago.com/793-5501/000-012



Item no.: 793-5501/000-014

WMB marking card; as card; for terminal block width 5 - 17.5 mm; stretchable 5 - 5.2 mm; plain; snap-on type; brown

www.wago.com/793-5501/000-014



Item no.: 793-5501/000-017

WMB marking card; as card; for terminal block width 5 - 17.5 mm; stretchable 5 - 5.2 mm; plain; snap-on type; green

www.wago.com/793-5501/000-017



Item no.: 793-5501/000-023

WMB marking card; as card; for terminal block width 5 - 17.5 mm; stretchable 5 - 5.2 mm; plain; snap-on type; light green

www.wago.com/793-5501/000-023



Item no.: 793-5501/000-024

WMB marking card; as card; for terminal block width 5 - 17.5 mm; stretchable 5 - 5.2 mm; plain; snap-on type; violet

www.wago.com/793-5501/000-024

End plate



Item no.: 2022-1291

End and intermediate plate; 1 mm thick; gray

www.wago.com/2022-1291



Item no.: 2022-1292

End and intermediate plate; 1 mm thick; orange

www.wago.com/2022-1292

Insulation stop

Item no.: 2002-171

Insulation stop; 0.25 - 0.5 mm²; 5 pieces/strip; light gray

www.wago.com/2002-171



Item no.: 2002-172

Insulation stop; 0.75 - 1 mm²; 5 pieces/strip; dark gray

www.wago.com/2002-172

Carrier rail

Item no.: 210-112

Steel carrier rail; 35 x 7.5 mm; 1 mm thick; 2 m long; slotted; according to EN 60715; "Hole width 25 mm

www.wago.com/210-112

Item no.: 210-113

Steel carrier rail; 35 x 7.5 mm; 1 mm thick; 2 m long; unslotted; according to EN 60715

www.wago.com/210-113

Item no.: 210-114

Steel carrier rail; 35 x 15 mm; 1.5 mm thick; 2 m long; unslotted; similar to EN 60715

www.wago.com/210-114

Subject to changes. Please also observe the further product documentation!

WAGO Kontakttechnik GmbH & Co. KG

Hansastr. 27













32423 Minden

Phone: +49571 887-0 | Fax: +49571 887-169















Email: info.de@wago.com | Web: www.wago.com

Do you have any questions about our products?

We are always happy to take your call at +49 (571) 887-44222.

	Item no.: 210-115 Steel carrier rail; 35 x 7.5 mm; 1 mm thick; 2 m long; slotted; according to EN 60715; "Hole width 18 mm	www.wago.com/210-115
	Item no.: 210-118 Steel carrier rail; 35 x 15 mm; 2.3 mm thick; 2 m long; unslotted; according to EN 60715	www.wago.com/210-118
	Item no.: 210-196 Aluminum carrier rail; 35 x 8.2 mm; 1.6 mm thick; 2 m long; unslotted; similar to EN 60715; silver-colored	www.wago.com/210-196
	Item no.: 210-197 Steel carrier rail; 35 x 15 mm; 1.5 mm thick; 2 m long; slotted; similar to EN 60715	www.wago.com/210-197
	Item no.: 210-198 Copper carrier rail; 35 x 15 mm; 2.3 mm thick; 2 m long; unslotted; according to EN 60715; copper-colored	www.wago.com/210-198
Push-In type wire jumper		
	Item no.: 2009-412 Push-in type wire jumper; insulated; wire length 60 mm; Conductor cross section 1.5 mm ² ; suitable for 2001, 2002, 2003 and 2022 Series rail-mounted terminal blocks; black	www.wago.com/2009-412
	Item no.: 2009-414 Push-in type wire jumper; insulated; wire length 110 mm; Conductor cross section 1.5 mm ² ; suitable for 2001, 2002, 2003 and 2022 Series rail-mounted terminal blocks; black	www.wago.com/2009-414
	Item no.: 2009-414/000-005 Push-in type wire jumper; insulated; wire length 110 mm; Conductor cross section 1.5 mm ² ; suitable for 2001, 2002, 2003 and 2022 Series rail-mounted terminal blocks; red	www.wago.com/2009-414/000-005
	Item no.: 2009-414/000-006 Push-in type wire jumper; insulated; wire length 110 mm; Conductor cross section 1.5 mm ² ; suitable for 2001, 2002, 2003 and 2022 Series rail-mounted terminal blocks; blue	www.wago.com/2009-414/000-006
	Item no.: 2009-416 Push-in type wire jumper; insulated; wire length 250 mm; Conductor cross section 1.5 mm ² ; suitable for 2001, 2002, 2003 and 2022 Series rail-mounted terminal blocks; black	www.wago.com/2009-416
Jumper		
	Item no.: 2002-400 Adjacent jumper for continuous commoning; insulated; 2-way; Nominal current 25 A; light gray	www.wago.com/2002-400
	Item no.: 2002-402 Push-in type jumper bar; insulated; 2-way; Nominal current 25 A; light gray	www.wago.com/2002-402
	Item no.: 2002-402/000-005 Push-in type jumper bar; insulated; 2-way; Nominal current 25 A; red	www.wago.com/2002-402/000-005
	Item no.: 2002-402/000-006 Push-in type jumper bar; insulated; 2-way; Nominal current 25 A; blue	www.wago.com/2002-402/000-006
	Item no.: 2002-403 Push-in type jumper bar; insulated; 3-way; Nominal current 25 A; light gray	www.wago.com/2002-403

Subject to changes. Please also observe the further product documentation!

	<p>Item no.: 2002-403/000-005 Push-in type jumper bar; insulated; 3-way; Nominal current 25 A; red</p>	www.wago.com/2002-403/000-005
	<p>Item no.: 2002-403/000-006 Push-in type jumper bar; insulated; 3-way; Nominal current 25 A; blue</p>	www.wago.com/2002-403/000-006
	<p>Item no.: 2002-404 Push-in type jumper bar; insulated; 4-way; Nominal current 25 A; light gray</p>	www.wago.com/2002-404
	<p>Item no.: 2002-404/000-005 Push-in type jumper bar; insulated; 4-way; Nominal current 25 A; red</p>	www.wago.com/2002-404/000-005
	<p>Item no.: 2002-404/000-006 Push-in type jumper bar; insulated; 4-way; Nominal current 25 A; blue</p>	www.wago.com/2002-404/000-006
	<p>Item no.: 2002-405 Push-in type jumper bar; insulated; 5-way; Nominal current 25 A; light gray</p>	www.wago.com/2002-405
	<p>Item no.: 2002-405/000-005 Push-in type jumper bar; insulated; 5-way; Nominal current 25 A; red</p>	www.wago.com/2002-405/000-005
	<p>Item no.: 2002-405/000-006 Push-in type jumper bar; insulated; 5-way; Nominal current 25 A; blue</p>	www.wago.com/2002-405/000-006
	<p>Item no.: 2002-405/011-000 Star point jumper; insulated; 3-way (1-3-5); IN = IN terminal block; light gray</p>	www.wago.com/2002-405/011-000
	<p>Item no.: 2002-406 Push-in type jumper bar; insulated; 6-way; Nominal current 25 A; light gray</p>	www.wago.com/2002-406
	<p>Item no.: 2002-406/000-005 Push-in type jumper bar; insulated; 6-way; Nominal current 25 A; red</p>	www.wago.com/2002-406/000-005
	<p>Item no.: 2002-406/000-006 Push-in type jumper bar; insulated; 6-way; Nominal current 25 A; blue</p>	www.wago.com/2002-406/000-006
	<p>Item no.: 2002-406/020-000 Delta jumper; insulated; 1-2 3-4 5-6; IN = IN terminal block; light gray</p>	www.wago.com/2002-406/020-000
	<p>Item no.: 2002-407 Push-in type jumper bar; insulated; 7-way; Nominal current 25 A; light gray</p>	www.wago.com/2002-407

Subject to changes. Please also observe the further product documentation!



Item no.: 2002-407/000-005
Push-in type jumper bar; insulated; 7-way; Nominal current 25 A; red

www.wago.com/2002-407/000-005



Item no.: 2002-407/000-006
Push-in type jumper bar; insulated; 7-way; Nominal current 25 A; blue

www.wago.com/2002-407/000-006



Item no.: 2002-408
Push-in type jumper bar; insulated; 8-way; Nominal current 25 A; light gray

www.wago.com/2002-408



Item no.: 2002-408/000-005
Push-in type jumper bar; insulated; 8-way; Nominal current 25 A; red

www.wago.com/2002-408/000-005



Item no.: 2002-408/000-006
Push-in type jumper bar; insulated; 8-way; Nominal current 25 A; blue

www.wago.com/2002-408/000-006



Item no.: 2002-409
Push-in type jumper bar; insulated; 9-way; Nominal current 25 A; light gray

www.wago.com/2002-409



Item no.: 2002-409/000-005
Push-in type jumper bar; insulated; 9-way; Nominal current 25 A; red

www.wago.com/2002-409/000-005



Item no.: 2002-409/000-006
Push-in type jumper bar; insulated; 9-way; Nominal current 25 A; blue

www.wago.com/2002-409/000-006



Item no.: 2002-410
Push-in type jumper bar; insulated; 10-way; Nominal current 25 A; light gray

www.wago.com/2002-410



Item no.: 2002-410/000-005
Push-in type jumper bar; insulated; 10-way; Nominal current 25 A; red

www.wago.com/2002-410/000-005



Item no.: 2002-410/000-006
Push-in type jumper bar; insulated; 10-way; Nominal current 25 A; blue

www.wago.com/2002-410/000-006



Item no.: 2002-423
Adjacent jumper for continuous commoning; insulated; from 1 to 3; Nominal current 25 A; light gray

www.wago.com/2002-423



Item no.: 2002-423/000-005
Adjacent jumper for continuous commoning; insulated; from 1 to 3; Nominal current 25 A; red





www.wago.com/2002-423/000-005













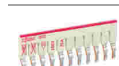
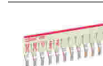

Item no.: 2002-423/000-006
Adjacent jumper for continuous commoning; insulated; from 1 to 3; Nominal current 25 A; blue

www.wago.com/2002-423/000-006

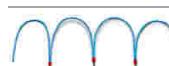

Subject to changes. Please also observe the further product documentation!

	Item no.: 2002-433 Push-in type jumper bar; insulated; from 1 to 3; Nominal current 25 A; light gray	www.wago.com/2002-433
	Item no.: 2002-434 Push-in type jumper bar; insulated; from 1 to 4; Nominal current 25 A; light gray	www.wago.com/2002-434
	Item no.: 2002-435 Push-in type jumper bar; insulated; from 1 to 5; Nominal current 25 A; light gray	www.wago.com/2002-435
	Item no.: 2002-436 Push-in type jumper bar; insulated; from 1 to 6; Nominal current 25 A; light gray	www.wago.com/2002-436
	Item no.: 2002-437 Push-in type jumper bar; insulated; from 1 to 7; Nominal current 25 A; light gray	www.wago.com/2002-437
	Item no.: 2002-438 Push-in type jumper bar; insulated; from 1 to 8; Nominal current 25 A; light gray	www.wago.com/2002-438
	Item no.: 2002-439 Push-in type jumper bar; insulated; from 1 to 9; Nominal current 25 A; light gray	www.wago.com/2002-439
	Item no.: 2002-440 Push-in type jumper bar; insulated; from 1 to 10; Nominal current 25 A; light gray	www.wago.com/2002-440
	Item no.: 2002-472 Staggered jumper; insulated; 2-way; Nominal current 25 A; suitable for 2002 and 2003 Series rail-mounted terminal blocks; light gray	www.wago.com/2002-472
	Item no.: 2002-473 Staggered jumper; insulated; 3-way; Nominal current 25 A; suitable for 2002 and 2003 Series rail-mounted terminal blocks; light gray	www.wago.com/2002-473
	Item no.: 2002-473/011-000 Ready-made staggered jumper; insulated; 2-way (1-3); Nominal current 25 A; with contact lugs broken off at the factory and circuit marking; light gray	www.wago.com/2002-473/011-000
	Item no.: 2002-474 Staggered jumper; insulated; 4-way; Nominal current 25 A; suitable for 2002 and 2003 Series rail-mounted terminal blocks; light gray	www.wago.com/2002-474
	Item no.: 2002-475 Staggered jumper; insulated; 5-way; Nominal current 25 A; suitable for 2002 and 2003 Series rail-mounted terminal blocks; light gray	www.wago.com/2002-475
	Item no.: 2002-475/011-000 Ready-made staggered jumper; insulated; 3-way (1-3-5); Nominal current 25 A; with contact lugs broken off at the factory and circuit marking; light gray	www.wago.com/2002-475/011-000
	Item no.: 2002-476 Staggered jumper; insulated; 6-way; Nominal current 25 A; suitable for 2002 and 2003 Series rail-mounted terminal blocks; light gray	www.wago.com/2002-476
	Item no.: 2002-477 Staggered jumper; insulated; 7-way; Nominal current 25 A; suitable for 2002 and 2003 Series rail-mounted terminal blocks; light gray	www.wago.com/2002-477















Subject to changes. Please also observe the further product documentation!

	Item no.: 2002-477/011-000 Ready-made staggered jumper; insulated; 1-3-5-7; Nominal current 25 A; with contact lugs broken off at the factory and circuit marking; light gray	www.wago.com/2002-477/011-000
	Item no.: 2002-478 Staggered jumper; insulated; 8-way; Nominal current 25 A; suitable for 2002 and 2003 Series rail-mounted terminal blocks; light gray	www.wago.com/2002-478
	Item no.: 2002-479 Staggered jumper; insulated; 9-way; Nominal current 25 A; suitable for 2002 and 2003 Series rail-mounted terminal blocks; light gray	www.wago.com/2002-479
	Item no.: 2002-479/011-000 Ready-made staggered jumper; insulated; 1-3-5-7-9; Nominal current 25 A; with contact lugs broken off at the factory and circuit marking; light gray	www.wago.com/2002-479/011-000
	Item no.: 2002-480 Staggered jumper; insulated; 10-way; Nominal current 25 A; suitable for 2002 and 2003 Series rail-mounted terminal blocks; light gray	www.wago.com/2002-480
	Item no.: 2002-481 Staggered jumper; insulated; 11-way; Nominal current 25 A; suitable for 2002 and 2003 Series rail-mounted terminal blocks; light gray	www.wago.com/2002-481
	Item no.: 2002-481/011-000 Ready-made staggered jumper; insulated; 1-3-5-7-9-11; Nominal current 25 A; with contact lugs broken off at the factory and circuit marking; light gray	www.wago.com/2002-481/011-000
	Item no.: 2002-482 Staggered jumper; insulated; 12-way; Nominal current 25 A; suitable for 2002 and 2003 Series rail-mounted terminal blocks; light gray	www.wago.com/2002-482
	Item no.: 210-103 Wire commoning chain; insulated; 50 connections; black	www.wago.com/210-103
	Item no.: 210-123 Wire commoning chain; insulated; 50 connections	www.wago.com/210-123
Coding		
	Item no.: 2022-100 Carrier with 6 coding pins; for coding of female plugs; orange	www.wago.com/2022-100
General accessories		
	Item no.: 2022-161 Start module for 1-conductor female connector; with integrated end plate; 2.5 mm ² ; 1-pole; 2,50 mm ² ; gray	www.wago.com/2022-161
	Item no.: 2022-162 Start module for 1-conductor female connector; with integrated end plate; 2.5 mm ² ; 1-pole; 2,50 mm ² ; orange	www.wago.com/2022-162
	Item no.: 2022-164 Start module for 1-conductor female connector; with integrated end plate; 2.5 mm ² ; 1-pole; 2,50 mm ² ; blue	www.wago.com/2022-164
	Item no.: 2022-167 Start module for 1-conductor female connector; with integrated end plate; 2.5 mm ² ; 1-pole; 2,50 mm ² ; green-yellow	www.wago.com/2022-167

Subject to changes. Please also observe the further product documentation!

	Item no.: 2022-171 Center module for 1-conductor female connector; 2.5 mm ² ; 1-pole; 2,50 mm ² ; gray	www.wago.com/2022-171
	Item no.: 2022-172 Center module for 1-conductor female connector; 2.5 mm ² ; 1-pole; 2,50 mm ² ; orange	www.wago.com/2022-172
	Item no.: 2022-174 Center module for 1-conductor female connector; 2.5 mm ² ; 1-pole; 2,50 mm ² ; blue	www.wago.com/2022-174
	Item no.: 2022-177 Center module for 1-conductor female connector; 2.5 mm ² ; 1-pole; 2,50 mm ² ; green-yellow	www.wago.com/2022-177
	Item no.: 2022-181 End module for 1-conductor female connector; 2.5 mm ² ; 1-pole; 2,50 mm ² ; gray	www.wago.com/2022-181
	Item no.: 2022-182 End module for 1-conductor female connector; 2.5 mm ² ; 1-pole; 2,50 mm ² ; orange	www.wago.com/2022-182
	Item no.: 2022-184 End module for 1-conductor female connector; 2.5 mm ² ; 1-pole; 2,50 mm ² ; blue	www.wago.com/2022-184
	Item no.: 2022-187 End module for 1-conductor female connector; 2.5 mm ² ; 1-pole; 2,50 mm ² ; green-yellow	www.wago.com/2022-187
ferrule		
	Item no.: 216-241 Ferrule; Sleeve for 0.5 mm ² / 20 AWG; insulated; electro-tin plated; electrolytic copper; gastight crimped; acc. to DIN 46228, Part 4/09.90; white	www.wago.com/216-241
	Item no.: 216-242 Ferrule; Sleeve for 0.75 mm ² / 18 AWG; insulated; electro-tin plated; electrolytic copper; gastight crimped; acc. to DIN 46228, Part 4/09.90; gray	www.wago.com/216-242
	Item no.: 216-243 Ferrule; Sleeve for 1 mm ² / AWG 18; insulated; electro-tin plated; electrolytic copper; gastight crimped; acc. to DIN 46228, Part 4/09.90; red	www.wago.com/216-243
	Item no.: 216-244 Ferrule; Sleeve for 1.5 mm ² / AWG 16; insulated; electro-tin plated; electrolytic copper; gastight crimped; acc. to DIN 46228, Part 4/09.90; black	www.wago.com/216-244
	Item no.: 216-246 Ferrule; Sleeve for 2.5 mm ² / AWG 14; insulated; electro-tin plated; electrolytic copper; gastight crimped; acc. to DIN 46228, Part 4/09.90; blue	www.wago.com/216-246
	Item no.: 216-262 Ferrule; Sleeve for 0.75 mm ² / 18 AWG; insulated; electro-tin plated; electrolytic copper; gastight crimped; acc. to DIN 46228, Part 4/09.90; gray	www.wago.com/216-262
	Item no.: 216-263 Ferrule; Sleeve for 1 mm ² / AWG 18; insulated; electro-tin plated; electrolytic copper; gastight crimped; acc. to DIN 46228, Part 4/09.90; red	www.wago.com/216-263
	Item no.: 216-264 Ferrule; Sleeve for 1.5 mm ² / AWG 16; insulated; electro-tin plated; electrolytic copper; gastight crimped; acc. to DIN 46228, Part 4/09.90; black	www.wago.com/216-264
	Item no.: 216-266	

Subject to changes. Please also observe the further product documentation!

	Ferrule; Sleeve for 2.5 mm ² / AWG 14; insulated; electro-tin plated; electrolytic copper; gastight crimped; acc. to DIN 46228, Part 4/09.90; blue	www.wago.com/216-266
	Item no.: 216-284 Ferrule; Sleeve for 1.5 mm ² / AWG 16; insulated; electro-tin plated; electrolytic copper; gastight crimped; acc. to DIN 46228, Part 4/09.90; black	www.wago.com/216-284
	Item no.: 216-286 Ferrule; Sleeve for 2.5 mm ² / AWG 14; insulated; electro-tin plated; electrolytic copper; gastight crimped; acc. to DIN 46228, Part 4/09.90; blue	www.wago.com/216-286
tools		
	Item no.: 210-720 Operating tool; Blade: 3.5 x 0.5 mm; with a partially insulated shaft	www.wago.com/210-720
Test Accessories		
	Item no.: 2002-511 Modular TOPJOB®S connector; modular; for jumper contact slot; 1-pole; 2,50 mm ² ; gray	www.wago.com/2002-511
	Item no.: 2002-549 Spacer module; modular; e.g., for bridging commoned terminal blocks; gray	www.wago.com/2002-549
	Item no.: 2002-552 Modular TOPJOB®S connector; modular; for jumper contact slot; 2-pole; 2,50 mm ² ; gray	www.wago.com/2002-552
	Item no.: 2002-553 Modular TOPJOB®S connector; modular; for jumper contact slot; 3-pole; 2,50 mm ² ; gray	www.wago.com/2002-553
	Item no.: 2002-554 Modular TOPJOB®S connector; modular; for jumper contact slot; 4-pole; 2,50 mm ² ; gray	www.wago.com/2002-554
	Item no.: 2002-555 Modular TOPJOB®S connector; modular; for jumper contact slot; 5-pole; 2,50 mm ² ; gray	www.wago.com/2002-555
	Item no.: 2002-556 Modular TOPJOB®S connector; modular; for jumper contact slot; 6-pole; 2,50 mm ² ; gray	www.wago.com/2002-556
	Item no.: 2002-557 Modular TOPJOB®S connector; modular; for jumper contact slot; 7-pole; 2,50 mm ² ; gray	www.wago.com/2002-557
	Item no.: 2002-558 Modular TOPJOB®S connector; modular; for jumper contact slot; 8-pole; 2,50 mm ² ; gray	www.wago.com/2002-558
	Item no.: 2002-559 Modular TOPJOB®S connector; modular; for jumper contact slot; 9-pole; 2,50 mm ² ; gray	www.wago.com/2002-559
	Item no.: 2002-560 Modular TOPJOB®S connector; modular; for jumper contact slot; 10-pole; 2,50 mm ² ; gray	www.wago.com/2002-560
	Item no.: 2009-174 Test plug adapter; for 4 mm Ø test plugs; for testing TOPJOB®S rail-mounted terminal blocks; gray	www.wago.com/2009-174
	Item no.: 2009-182 Testing tap; for max. 2.5 mm ² ; tool-free connection for individual test wires 0.08 - 2.5 mm; gray	www.wago.com/2009-182

Subject to changes. Please also observe the further product documentation!

**Item no.: 859-500**

Test pin; 1 mm Ø; with solder connection for test wire

www.wago.com/859-500**Protective Warning Marker****Item no.: 2002-115**

Protective warning marker; with high-voltage symbol, black; for 5 terminal blocks; yellow

www.wago.com/2002-115**Female plug****Item no.: 2022-101**1-conductor female plug; 2.5 mm²; 1-pole; 2,50 mm²; graywww.wago.com/2022-101**Item no.: 2022-101/000-006**1-conductor female plug; 1-pole; 2,50 mm²; bluewww.wago.com/2022-101/000-006**Item no.: 2022-101/000-012**1-conductor female plug; 1-pole; 2,50 mm²; orangewww.wago.com/2022-101/000-012**Item no.: 2022-101/000-016**1-conductor female plug; 1-pole; 2,50 mm²; green-yellowwww.wago.com/2022-101/000-016**Item no.: 2022-101/122-000**1-conductor female plug; 1-pole; 2,50 mm²; graywww.wago.com/2022-101/122-000**Item no.: 2022-101/122-006**1-conductor female plug; 1-pole; 2,50 mm²; bluewww.wago.com/2022-101/122-006**Item no.: 2022-101/122-016**1-conductor female plug; 1-pole; 2,50 mm²; green-yellowwww.wago.com/2022-101/122-016**Item no.: 2022-101/132-000**1-conductor female plug; Strain relief plate; 1-pole; 2,50 mm²; graywww.wago.com/2022-101/132-000**Item no.: 2022-101/132-006**1-conductor female plug; Strain relief plate; 1-pole; 2,50 mm²; bluewww.wago.com/2022-101/132-006**Item no.: 2022-101/132-016**1-conductor female plug; Strain relief plate; 1-pole; 2,50 mm²; green-yellowwww.wago.com/2022-101/132-016**Item no.: 2022-101/142-000**1-conductor female plug; Strain relief plate; 1-pole; 2,50 mm²; graywww.wago.com/2022-101/142-000

Subject to changes. Please also observe the further product documentation!

WAGO Kontakttechnik GmbH & Co. KG

Hansastr. 27









32423 Minden

Phone: +49571 887-0 | Fax: +49571 887-169











Email: info.de@wago.com | Web: www.wago.com

Do you have any questions about our products?











We are always happy to take your call at +49 (571) 887-44222.

	Item no.: 2022-101/142-006 1-conductor female plug; Strain relief plate; 1-pole; 2,50 mm ² ; blue	www.wago.com/2022-101/142-006
	Item no.: 2022-101/142-016 1-conductor female plug; Strain relief plate; 1-pole; 2,50 mm ² ; green-yellow	www.wago.com/2022-101/142-016
	Item no.: 2022-102 1-conductor female plug; 2.5 mm ² ; 2-pole; 2,50 mm ² ; gray	www.wago.com/2022-102
	Item no.: 2022-102/000-006 1-conductor female plug; 2.5 mm ² ; 2-pole; 2,50 mm ² ; blue	www.wago.com/2022-102/000-006
	Item no.: 2022-102/000-012 1-conductor female plug; 2.5 mm ² ; 2-pole; 2,50 mm ² ; orange	www.wago.com/2022-102/000-012
	Item no.: 2022-102/000-016 1-conductor female plug; 2.5 mm ² ; 2-pole; 2,50 mm ² ; green-yellow	www.wago.com/2022-102/000-016
	Item no.: 2022-102/000-038 1-conductor female plug; 2.5 mm ² ; 2-pole; 2,50 mm ² ; blue/gray	www.wago.com/2022-102/000-038
	Item no.: 2022-102/000-039 1-conductor female plug; 2.5 mm ² ; 2-pole; 2,50 mm ² ; green-yellow/blue/gray	www.wago.com/2022-102/000-039
	Item no.: 2022-102/122-000 1-conductor female plug; Locking lever; 2.5 mm ² ; 2-pole; 2,50 mm ² ; gray	www.wago.com/2022-102/122-000
	Item no.: 2022-102/132-000 1-conductor female plug; Strain relief plate; 2.5 mm ² ; 2-pole; 2,50 mm ² ; gray	www.wago.com/2022-102/132-000
	Item no.: 2022-102/142-000 1-conductor female plug; Strain relief plate; 2.5 mm ² ; 2-pole; 2,50 mm ² ; gray	www.wago.com/2022-102/142-000
	Item no.: 2022-103 1-conductor female plug; 2.5 mm ² ; 3-pole; 2,50 mm ² ; gray	www.wago.com/2022-103
	Item no.: 2022-103/000-006 1-conductor female plug; 2.5 mm ² ; 3-pole; 2,50 mm ² ; blue	www.wago.com/2022-103/000-006
	Item no.: 2022-103/000-012 1-conductor female plug; 2.5 mm ² ; 3-pole; 2,50 mm ² ; orange	www.wago.com/2022-103/000-012













Subject to changes. Please also observe the further product documentation!

	<p>Item no.: 2022-103/000-016 1-conductor female plug; 2.5 mm²; 3-pole; 2,50 mm²; green-yellow</p>	www.wago.com/2022-103/000-016
	<p>Item no.: 2022-103/000-036 1-conductor female plug; 2.5 mm²; 3-pole; 2,50 mm²; gray, green-yellow</p>	www.wago.com/2022-103/000-036
	<p>Item no.: 2022-103/000-037 1-conductor female plug; 2.5 mm²; 3-pole; 2,50 mm²; green-yellow, gray</p>	www.wago.com/2022-103/000-037
	<p>Item no.: 2022-103/000-038 1-conductor female plug; 2.5 mm²; 3-pole; 2,50 mm²; gray, blue, green-yellow</p>	www.wago.com/2022-103/000-038
	<p>Item no.: 2022-103/000-039 1-conductor female plug; 2.5 mm²; 3-pole; 2,50 mm²; green-yellow, blue, gray</p>	www.wago.com/2022-103/000-039
	<p>Item no.: 2022-103/123-000 1-conductor female plug; Locking lever; 2.5 mm²; 3-pole; 2,50 mm²; gray</p>	www.wago.com/2022-103/123-000
	<p>Item no.: 2022-103/133-000 1-conductor female plug; Strain relief plate; 2.5 mm²; 3-pole; 2,50 mm²; gray</p>	www.wago.com/2022-103/133-000
	<p>Item no.: 2022-103/143-000 1-conductor female plug; Strain relief plate; 2.5 mm²; 3-pole; 2,50 mm²; gray</p>	www.wago.com/2022-103/143-000
	<p>Item no.: 2022-104 1-conductor female plug; 2.5 mm²; 4-pole; 2,50 mm²; gray</p>	www.wago.com/2022-104
	<p>Item no.: 2022-104/000-006 1-conductor female plug; 2.5 mm²; 4-pole; 2,50 mm²; blue</p>	www.wago.com/2022-104/000-006
	<p>Item no.: 2022-104/000-012 1-conductor female plug; 2.5 mm²; 4-pole; 2,50 mm²; orange</p>	www.wago.com/2022-104/000-012
	<p>Item no.: 2022-104/000-016 1-conductor female plug; 2.5 mm²; 4-pole; 2,50 mm²; green-yellow</p>	www.wago.com/2022-104/000-016
	<p>Item no.: 2022-104/000-036 1-conductor female plug; 2.5 mm²; 4-pole; 2,50 mm²; gray, green-yellow</p>	www.wago.com/2022-104/000-036









Subject to changes. Please also observe the further product documentation!

	<p>Item no.: 2022-104/000-037 1-conductor female plug; 2.5 mm²; 4-pole; 2,50 mm²; green-yellow, gray</p>	www.wago.com/2022-104/000-037
	<p>Item no.: 2022-104/000-038 1-conductor female plug; 2.5 mm²; 4-pole; 2,50 mm²; gray, blue, green-yellow</p>	www.wago.com/2022-104/000-038
	<p>Item no.: 2022-104/000-039 1-conductor female plug; 2.5 mm²; 4-pole; 2,50 mm²; green-yellow, blue, gray</p>	www.wago.com/2022-104/000-039
	<p>Item no.: 2022-104/123-000 1-conductor female plug; Locking lever; 2.5 mm²; 4-pole; 2,50 mm²; gray</p>	www.wago.com/2022-104/123-000
	<p>Item no.: 2022-104/133-000 1-conductor female plug; Strain relief plate; 2.5 mm²; 4-pole; 2,50 mm²; gray</p>	www.wago.com/2022-104/133-000
	<p>Item no.: 2022-104/143-000 1-conductor female plug; Strain relief plate; 2.5 mm²; 4-pole; 2,50 mm²; gray</p>	www.wago.com/2022-104/143-000
	<p>Item no.: 2022-105 1-conductor female plug; 2.5 mm²; 5-pole; 2,50 mm²; gray</p>	www.wago.com/2022-105
	<p>Item no.: 2022-105/000-006 1-conductor female plug; 2.5 mm²; 5-pole; 2,50 mm²; blue</p>	www.wago.com/2022-105/000-006
	<p>Item no.: 2022-105/000-012 1-conductor female plug; 2.5 mm²; 5-pole; 2,50 mm²; orange</p>	www.wago.com/2022-105/000-012
	<p>Item no.: 2022-105/000-016 1-conductor female plug; 2.5 mm²; 5-pole; 2,50 mm²; green-yellow</p>	www.wago.com/2022-105/000-016
	<p>Item no.: 2022-105/000-036 1-conductor female plug; 2.5 mm²; 5-pole; 2,50 mm²; gray, green-yellow</p>	www.wago.com/2022-105/000-036
	<p>Item no.: 2022-105/000-037 1-conductor female plug; 2.5 mm²; 5-pole; 2,50 mm²; green-yellow, gray</p>	www.wago.com/2022-105/000-037
	<p>Item no.: 2022-105/000-038 1-conductor female plug; 2.5 mm²; 5-pole; 2,50 mm²; gray, blue, green-yellow</p>	www.wago.com/2022-105/000-038











Subject to changes. Please also observe the further product documentation!

	<p>Item no.: 2022-105/000-039 1-conductor female plug; 2.5 mm²; 5-pole; 2,50 mm²; green-yellow, blue, gray</p>	www.wago.com/2022-105/000-039
	<p>Item no.: 2022-105/123-000 1-conductor female plug; Locking lever; 2.5 mm²; 5-pole; 2,50 mm²; gray</p>	www.wago.com/2022-105/123-000
	<p>Item no.: 2022-105/134-000 1-conductor female plug; Strain relief plate; 2.5 mm²; 5-pole; 2,50 mm²; gray</p>	www.wago.com/2022-105/134-000
	<p>Item no.: 2022-105/144-000 1-conductor female plug; Strain relief plate; 2.5 mm²; 5-pole; 2,50 mm²; gray</p>	www.wago.com/2022-105/144-000
	<p>Item no.: 2022-106 1-conductor female plug; 2.5 mm²; 6-pole; 2,50 mm²; gray</p>	www.wago.com/2022-106
	<p>Item no.: 2022-106/000-006 1-conductor female plug; 2.5 mm²; 6-pole; 2,50 mm²; blue</p>	www.wago.com/2022-106/000-006
	<p>Item no.: 2022-106/000-012 1-conductor female plug; 2.5 mm²; 6-pole; 2,50 mm²; orange</p>	www.wago.com/2022-106/000-012
	<p>Item no.: 2022-106/000-016 1-conductor female plug; 2.5 mm²; 6-pole; 2,50 mm²; green-yellow</p>	www.wago.com/2022-106/000-016
	<p>Item no.: 2022-106/000-036 1-conductor female plug; 2.5 mm²; 6-pole; 2,50 mm²; gray, green-yellow</p>	www.wago.com/2022-106/000-036
	<p>Item no.: 2022-106/000-037 1-conductor female plug; 2.5 mm²; 6-pole; 2,50 mm²; green-yellow, gray</p>	www.wago.com/2022-106/000-037
	<p>Item no.: 2022-106/000-038 1-conductor female plug; 2.5 mm²; 6-pole; 2,50 mm²; gray, blue, green-yellow</p>	www.wago.com/2022-106/000-038
	<p>Item no.: 2022-106/000-039 1-conductor female plug; 2.5 mm²; 6-pole; 2,50 mm²; green-yellow, blue, gray</p>	www.wago.com/2022-106/000-039
	<p>Item no.: 2022-106/123-000 1-conductor female plug; Locking lever; 2.5 mm²; 6-pole; 2,50 mm²; gray</p>	www.wago.com/2022-106/123-000











Subject to changes. Please also observe the further product documentation!

	<p>Item no.: 2022-106/134-000 1-conductor female plug; Strain relief plate; 2.5 mm²; 6-pole; 2,50 mm²; gray</p>	<p>www.wago.com/2022-106/134-000</p>
	<p>Item no.: 2022-106/144-000 1-conductor female plug; Strain relief plate; 2.5 mm²; 6-pole; 2,50 mm²; gray</p>	<p>www.wago.com/2022-106/144-000</p>
	<p>Item no.: 2022-107 1-conductor female plug; 2.5 mm²; 7-pole; 2,50 mm²; gray</p>	<p>www.wago.com/2022-107</p>
	<p>Item no.: 2022-107/000-006 1-conductor female plug; 2.5 mm²; 7-pole; 2,50 mm²; blue</p>	<p>www.wago.com/2022-107/000-006</p>
	<p>Item no.: 2022-107/000-012 1-conductor female plug; 2.5 mm²; 7-pole; 2,50 mm²; orange</p>	<p>www.wago.com/2022-107/000-012</p>
	<p>Item no.: 2022-107/000-016 1-conductor female plug; 2.5 mm²; 7-pole; 2,50 mm²; green-yellow</p>	<p>www.wago.com/2022-107/000-016</p>
	<p>Item no.: 2022-107/000-036 1-conductor female plug; 2.5 mm²; 7-pole; 2,50 mm²; gray, green-yellow</p>	<p>www.wago.com/2022-107/000-036</p>
	<p>Item no.: 2022-107/000-037 1-conductor female plug; 2.5 mm²; 7-pole; 2,50 mm²; green-yellow, gray</p>	<p>www.wago.com/2022-107/000-037</p>
	<p>Item no.: 2022-107/000-038 1-conductor female plug; 2.5 mm²; 7-pole; 2,50 mm²; gray, blue, green-yellow</p>	<p>www.wago.com/2022-107/000-038</p>
	<p>Item no.: 2022-107/000-039 1-conductor female plug; 2.5 mm²; 7-pole; 2,50 mm²; green-yellow, blue, gray</p>	<p>www.wago.com/2022-107/000-039</p>
	<p>Item no.: 2022-107/123-000 1-conductor female plug; Locking lever; 2.5 mm²; 7-pole; 2,50 mm²; gray</p>	<p>www.wago.com/2022-107/123-000</p>
	<p>Item no.: 2022-107/135-000 1-conductor female plug; Strain relief plate; 2.5 mm²; 7-pole; 2,50 mm²; gray</p>	<p>www.wago.com/2022-107/135-000</p>
	<p>Item no.: 2022-107/145-000 1-conductor female plug; Strain relief plate; 2.5 mm²; 7-pole; 2,50 mm²; gray</p>	<p>www.wago.com/2022-107/145-000</p>
	<p>Item no.: 2022-108 1-conductor female plug; 2.5 mm²; 8-pole; 2,50 mm²; gray</p>	<p>www.wago.com/2022-108</p>











Subject to changes. Please also observe the further product documentation!

	<p>Item no.: 2022-108/000-006 1-conductor female plug; 2.5 mm²; 8-pole; 2,50 mm²; blue</p>	www.wago.com/2022-108/000-006
	<p>Item no.: 2022-108/000-012 1-conductor female plug; 2.5 mm²; 8-pole; 2,50 mm²; orange</p>	www.wago.com/2022-108/000-012
	<p>Item no.: 2022-108/000-016 1-conductor female plug; 2.5 mm²; 8-pole; 2,50 mm²; green-yellow</p>	www.wago.com/2022-108/000-016
	<p>Item no.: 2022-108/000-036 1-conductor female plug; 2.5 mm²; 8-pole; 2,50 mm²; gray, green-yellow</p>	www.wago.com/2022-108/000-036
	<p>Item no.: 2022-108/000-037 1-conductor female plug; 2.5 mm²; 8-pole; 2,50 mm²; green-yellow, gray</p>	www.wago.com/2022-108/000-037
	<p>Item no.: 2022-108/000-038 1-conductor female plug; 2.5 mm²; 8-pole; 2,50 mm²; gray, blue, green-yellow</p>	www.wago.com/2022-108/000-038
	<p>Item no.: 2022-108/000-039 1-conductor female plug; 2.5 mm²; 8-pole; 2,50 mm²; green-yellow, blue, gray</p>	www.wago.com/2022-108/000-039
	<p>Item no.: 2022-108/123-000 1-conductor female plug; Locking lever; 2.5 mm²; 8-pole; 2,50 mm²; gray</p>	www.wago.com/2022-108/123-000
	<p>Item no.: 2022-108/135-000 1-conductor female plug; Strain relief plate; 2.5 mm²; 8-pole; 2,50 mm²; gray</p>	www.wago.com/2022-108/135-000
	<p>Item no.: 2022-108/145-000 1-conductor female plug; Strain relief plate; 2.5 mm²; 8-pole; 2,50 mm²; gray</p>	www.wago.com/2022-108/145-000
	<p>Item no.: 2022-109 1-conductor female plug; 2.5 mm²; 9-pole; 2,50 mm²; gray</p>	www.wago.com/2022-109
	<p>Item no.: 2022-109/000-006 1-conductor female plug; 2.5 mm²; 9-pole; 2,50 mm²; blue</p>	www.wago.com/2022-109/000-006
	<p>Item no.: 2022-109/000-012 1-conductor female plug; 2.5 mm²; 9-pole; 2,50 mm²; orange</p>	www.wago.com/2022-109/000-012

Subject to changes. Please also observe the further product documentation!

	<p>Item no.: 2022-109/000-016 1-conductor female plug; 2.5 mm²; 9-pole; 2,50 mm²; green-yellow</p>	www.wago.com/2022-109/000-016
	<p>Item no.: 2022-109/000-036 1-conductor female plug; 2.5 mm²; 9-pole; 2,50 mm²; gray, green-yellow</p>	www.wago.com/2022-109/000-036
	<p>Item no.: 2022-109/000-037 1-conductor female plug; 2.5 mm²; 9-pole; 2,50 mm²; green-yellow, gray</p>	www.wago.com/2022-109/000-037
	<p>Item no.: 2022-109/000-038 1-conductor female plug; 2.5 mm²; 9-pole; 2,50 mm²; gray, blue, green-yellow</p>	www.wago.com/2022-109/000-038
	<p>Item no.: 2022-109/000-039 1-conductor female plug; 2.5 mm²; 9-pole; 2,50 mm²; green-yellow, blue, gray</p>	www.wago.com/2022-109/000-039
	<p>Item no.: 2022-109/123-000 1-conductor female plug; Locking lever; 2.5 mm²; 9-pole; 2,50 mm²; gray</p>	www.wago.com/2022-109/123-000
	<p>Item no.: 2022-109/135-000 1-conductor female plug; Strain relief plate; 2.5 mm²; 9-pole; 2,50 mm²; gray</p>	www.wago.com/2022-109/135-000
	<p>Item no.: 2022-109/145-000 1-conductor female plug; Strain relief plate; 2.5 mm²; 9-pole; 2,50 mm²; gray</p>	www.wago.com/2022-109/145-000
	<p>Item no.: 2022-110 1-conductor female plug; 2.5 mm²; 10-pole; 2,50 mm²; gray</p>	www.wago.com/2022-110
	<p>Item no.: 2022-110/000-006 1-conductor female plug; 2.5 mm²; 10-pole; 2,50 mm²; blue</p>	www.wago.com/2022-110/000-006
	<p>Item no.: 2022-110/000-012 1-conductor female plug; 2.5 mm²; 10-pole; 2,50 mm²; orange</p>	www.wago.com/2022-110/000-012
	<p>Item no.: 2022-110/000-016 1-conductor female plug; 2.5 mm²; 10-pole; 2,50 mm²; green-yellow</p>	www.wago.com/2022-110/000-016
	<p>Item no.: 2022-110/000-036 1-conductor female plug; 2.5 mm²; 10-pole; 2,50 mm²; gray, green-yellow</p>	www.wago.com/2022-110/000-036

Subject to changes. Please also observe the further product documentation!

	<p>Item no.: 2022-110/000-037 1-conductor female plug; 2.5 mm²; 10-pole; 2,50 mm²; green-yellow, gray</p>	www.wago.com/2022-110/000-037
	<p>Item no.: 2022-110/000-038 1-conductor female plug; 2.5 mm²; 10-pole; 2,50 mm²; gray, blue, green-yellow</p>	www.wago.com/2022-110/000-038
	<p>Item no.: 2022-110/000-039 1-conductor female plug; 2.5 mm²; 10-pole; 2,50 mm²; green-yellow, blue, gray</p>	www.wago.com/2022-110/000-039
	<p>Item no.: 2022-110/123-000 1-conductor female plug; Locking lever; 2.5 mm²; 10-pole; 2,50 mm²; gray</p>	www.wago.com/2022-110/123-000
	<p>Item no.: 2022-110/135-000 1-conductor female plug; Strain relief plate; 2.5 mm²; 10-pole; 2,50 mm²; gray</p>	www.wago.com/2022-110/135-000
	<p>Item no.: 2022-110/145-000 1-conductor female plug; Strain relief plate; 2.5 mm²; 10-pole; 2,50 mm²; gray</p>	www.wago.com/2022-110/145-000
	<p>Item no.: 2022-111 1-conductor female plug; 2.5 mm²; 11-pole; 2,50 mm²; gray</p>	www.wago.com/2022-111
	<p>Item no.: 2022-111/000-006 1-conductor female plug; 2.5 mm²; 11-pole; 2,50 mm²; blue</p>	www.wago.com/2022-111/000-006
	<p>Item no.: 2022-111/000-012 1-conductor female plug; 2.5 mm²; 11-pole; 2,50 mm²; orange</p>	www.wago.com/2022-111/000-012
	<p>Item no.: 2022-111/000-016 1-conductor female plug; 2.5 mm²; 11-pole; 2,50 mm²; green-yellow</p>	www.wago.com/2022-111/000-016
	<p>Item no.: 2022-111/000-036 1-conductor female plug; 2.5 mm²; 11-pole; 2,50 mm²; gray, green-yellow</p>	www.wago.com/2022-111/000-036
	<p>Item no.: 2022-111/000-037 1-conductor female plug; 2.5 mm²; 11-pole; 2,50 mm²; green-yellow, gray</p>	www.wago.com/2022-111/000-037
	<p>Item no.: 2022-111/000-038 1-conductor female plug; 2.5 mm²; 11-pole; 2,50 mm²; gray, blue, green-yellow</p>	www.wago.com/2022-111/000-038

Subject to changes. Please also observe the further product documentation!



Item no.: 2022-111/000-039
1-conductor female plug; 2.5 mm²; 11-pole; 2,50 mm²; green-yellow, blue, gray

www.wago.com/2022-111/000-039

Item no.: 2022-111/126-000
1-conductor female plug; Locking lever; 2.5 mm²; 11-pole; 2,50 mm²; gray

www.wago.com/2022-111/126-000

Item no.: 2022-111/136-000
1-conductor female plug; Strain relief plate; 2.5 mm²; 11-pole; 2,50 mm²; gray

www.wago.com/2022-111/136-000

Item no.: 2022-111/146-000
1-conductor female plug; Strain relief plate; 2.5 mm²; 11-pole; 2,50 mm²; gray

www.wago.com/2022-111/146-000



Item no.: 2022-112
1-conductor female plug; 2.5 mm²; 12-pole; 2,50 mm²; gray

www.wago.com/2022-112



Item no.: 2022-112/000-006
1-conductor female plug; 2.5 mm²; 12-pole; 2,50 mm²; blue

www.wago.com/2022-112/000-006



Item no.: 2022-112/000-012
1-conductor female plug; 2.5 mm²; 12-pole; 2,50 mm²; orange

www.wago.com/2022-112/000-012



Item no.: 2022-112/000-016
1-conductor female plug; 2.5 mm²; 12-pole; 2,50 mm²; green-yellow

www.wago.com/2022-112/000-016



Item no.: 2022-112/000-036
1-conductor female plug; 2.5 mm²; 12-pole; 2,50 mm²; gray, green-yellow

www.wago.com/2022-112/000-036



Item no.: 2022-112/000-037
1-conductor female plug; 2.5 mm²; 12-pole; 2,50 mm²; green-yellow, gray

www.wago.com/2022-112/000-037



Item no.: 2022-112/000-038
1-conductor female plug; 2.5 mm²; 12-pole; 2,50 mm²; gray, blue, green-yellow

www.wago.com/2022-112/000-038











Item no.: 2022-112/000-039
1-conductor female plug; 2.5 mm²; 12-pole; 2,50 mm²; green-yellow, blue, gray

www.wago.com/2022-112/000-039











Item no.: 2022-112/126-000
1-conductor female plug; Locking lever; 2.5 mm²; 12-pole; 2,50 mm²; gray

www.wago.com/2022-112/126-000





Subject to changes. Please also observe the further product documentation!

	Item no.: 2022-112/136-000 1-conductor female plug; Strain relief plate; 2.5 mm ² ; 12-pole; 2,50 mm ² ; gray	www.wago.com/2022-112/136-000
	Item no.: 2022-112/146-000 1-conductor female plug; Strain relief plate; 2.5 mm ² ; 12-pole; 2,50 mm ² ; gray	www.wago.com/2022-112/146-000
	Item no.: 2022-113 1-conductor female plug; 2.5 mm ² ; 13-pole; 2,50 mm ² ; gray	www.wago.com/2022-113
	Item no.: 2022-113/000-006 1-conductor female plug; 2.5 mm ² ; 13-pole; 2,50 mm ² ; blue	www.wago.com/2022-113/000-006
	Item no.: 2022-113/000-012 1-conductor female plug; 2.5 mm ² ; 13-pole; 2,50 mm ² ; orange	www.wago.com/2022-113/000-012
	Item no.: 2022-113/000-016 1-conductor female plug; 2.5 mm ² ; 13-pole; 2,50 mm ² ; green-yellow	www.wago.com/2022-113/000-016
	Item no.: 2022-113/000-036 1-conductor female plug; 2.5 mm ² ; 13-pole; 2,50 mm ² ; gray, green-yellow	www.wago.com/2022-113/000-036
	Item no.: 2022-113/000-037 1-conductor female plug; 2.5 mm ² ; 13-pole; 2,50 mm ² ; green-yellow, gray	www.wago.com/2022-113/000-037
	Item no.: 2022-113/000-038 1-conductor female plug; 2.5 mm ² ; 13-pole; 2,50 mm ² ; gray, blue, green-yellow	www.wago.com/2022-113/000-038
	Item no.: 2022-113/000-039 1-conductor female plug; 2.5 mm ² ; 13-pole; 2,50 mm ² ; green-yellow, blue, gray	www.wago.com/2022-113/000-039
	Item no.: 2022-113/126-000 1-conductor female plug; Locking lever; 2.5 mm ² ; 13-pole; 2,50 mm ² ; gray	www.wago.com/2022-113/126-000
	Item no.: 2022-113/136-000 1-conductor female plug; Strain relief plate; 2.5 mm ² ; 13-pole; 2,50 mm ² ; gray	www.wago.com/2022-113/136-000
	Item no.: 2022-113/146-000 1-conductor female plug; Strain relief plate; 2.5 mm ² ; 13-pole; 2,50 mm ² ; gray	www.wago.com/2022-113/146-000
	Item no.: 2022-114 1-conductor female plug; 2.5 mm ² ; 14-pole; 2,50 mm ² ; gray	www.wago.com/2022-114

Subject to changes. Please also observe the further product documentation!

	<p>Item no.: 2022-114/000-006 1-conductor female plug; 2.5 mm²; 14-pole; 2,50 mm²; blue</p>	www.wago.com/2022-114/000-006
	<p>Item no.: 2022-114/000-012 1-conductor female plug; 2.5 mm²; 14-pole; 2,50 mm²; orange</p>	www.wago.com/2022-114/000-012
	<p>Item no.: 2022-114/000-016 1-conductor female plug; 2.5 mm²; 14-pole; 2,50 mm²; green-yellow</p>	www.wago.com/2022-114/000-016
	<p>Item no.: 2022-114/000-036 1-conductor female plug; 2.5 mm²; 14-pole; 2,50 mm²; gray, green-yellow</p>	www.wago.com/2022-114/000-036
	<p>Item no.: 2022-114/000-037 1-conductor female plug; 2.5 mm²; 14-pole; 2,50 mm²; green-yellow, gray</p>	www.wago.com/2022-114/000-037
	<p>Item no.: 2022-114/000-038 1-conductor female plug; 2.5 mm²; 14-pole; 2,50 mm²; gray, blue, green-yellow</p>	www.wago.com/2022-114/000-038
	<p>Item no.: 2022-114/000-039 1-conductor female plug; 2.5 mm²; 14-pole; 2,50 mm²; green-yellow, blue, gray</p>	www.wago.com/2022-114/000-039
	<p>Item no.: 2022-114/126-000 1-conductor female plug; Locking lever; 2.5 mm²; 14-pole; 2,50 mm²; gray</p>	www.wago.com/2022-114/126-000
	<p>Item no.: 2022-114/136-000 1-conductor female plug; Strain relief plate; 2.5 mm²; 14-pole; 2,50 mm²; gray</p>	www.wago.com/2022-114/136-000
	<p>Item no.: 2022-114/146-000 1-conductor female plug; Strain relief plate; 2.5 mm²; 14-pole; 2,50 mm²; gray</p>	www.wago.com/2022-114/146-000
	<p>Item no.: 2022-115 1-conductor female plug; 2.5 mm²; 15-pole; 2,50 mm²; gray</p>	www.wago.com/2022-115
	<p>Item no.: 2022-115/000-006 1-conductor female plug; 2.5 mm²; 15-pole; 2,50 mm²; blue</p>	www.wago.com/2022-115/000-006
	<p>Item no.: 2022-115/000-012 1-conductor female plug; 2.5 mm²; 15-pole; 2,50 mm²; orange</p>	www.wago.com/2022-115/000-012

Subject to changes. Please also observe the further product documentation!

	Item no.: 2022-115/000-016 1-conductor female plug; 2.5 mm ² ; 15-pole; 2,50 mm ² ; green-yellow	www.wago.com/2022-115/000-016
	Item no.: 2022-115/000-036 1-conductor female plug; 2.5 mm ² ; 15-pole; 2,50 mm ² ; gray, green-yellow	www.wago.com/2022-115/000-036
	Item no.: 2022-115/000-037 1-conductor female plug; 2.5 mm ² ; 15-pole; 2,50 mm ² ; green-yellow, gray	www.wago.com/2022-115/000-037
	Item no.: 2022-115/000-038 1-conductor female plug; 2.5 mm ² ; 15-pole; 2,50 mm ² ; gray, blue, green-yellow	www.wago.com/2022-115/000-038
	Item no.: 2022-115/000-039 1-conductor female plug; 2.5 mm ² ; 15-pole; 2,50 mm ² ; green-yellow, blue, gray	www.wago.com/2022-115/000-039
	Item no.: 2022-115/127-000 1-conductor female plug; Locking lever; 2.5 mm ² ; 15-pole; 2,50 mm ² ; gray	www.wago.com/2022-115/127-000
	Item no.: 2022-115/137-000 1-conductor female plug; Strain relief plate; 2.5 mm ² ; 15-pole; 2,50 mm ² ; gray	www.wago.com/2022-115/137-000
	Item no.: 2022-115/147-000 1-conductor female plug; Strain relief plate; 2.5 mm ² ; 15-pole; 2,50 mm ² ; gray	www.wago.com/2022-115/147-000

Downloads

Documentation

Additional Information

Technical explanations	Apr 3, 2019	pdf 2.1 MB	Download
------------------------	-------------	---------------	----------

CAD/CAE-Data

CAD data

2D/3D Models 2022-1201	URL	Download
------------------------	-----	----------

CAE data

EPLAN Data Portal 2022-1201	URL	Download
-----------------------------	-----	----------

Subject to changes. Please also observe the further product documentation!

Installation Notes

Installation

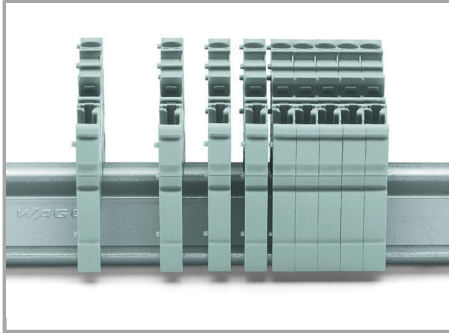

Snap individual carrier terminal blocks onto the carrier rail and slide together.

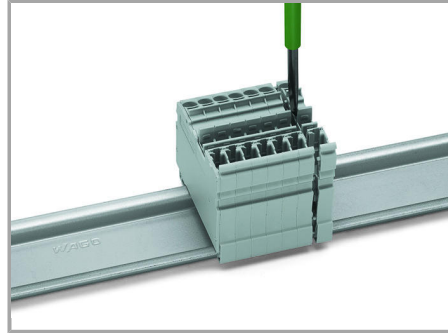

Open the assembly by laterally sliding a block via operating tool (3.5 x 0.5 mm blade).

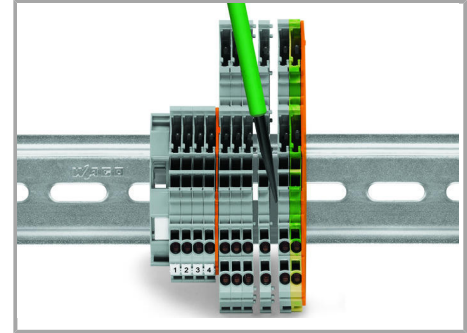

Separate terminal block assembly and slide individual terminal blocks laterally using an operating tool.

Inserting a conductor

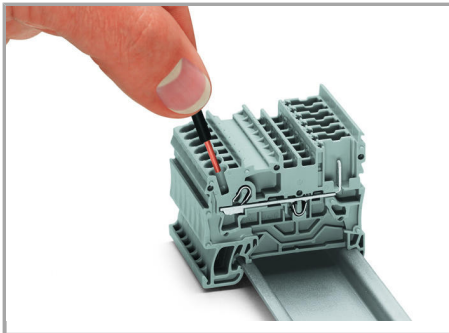

Push-in CAGE CLAMP® enables solid conductors and fine-stranded conductors with ferrules to be connected by simply pushing them into the unit.

Commoning

Subject to changes. Please also observe the further product documentation!

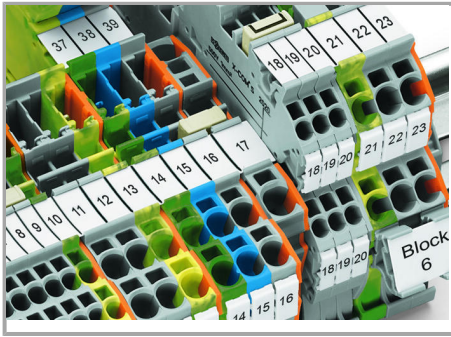

Commoning X-COM®S-SYSTEM Terminal Blocks using jumpers for TOPJOB® S Terminal Blocks. An end plate provides connection to TOPJOB® S Terminal Blocks. 2020 and 2022 Series Terminal Blocks are combinable. Jumper slots are on the same level for both series.

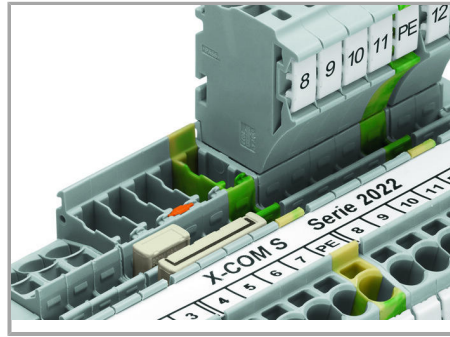

Pairing push-in comb style jumpers.

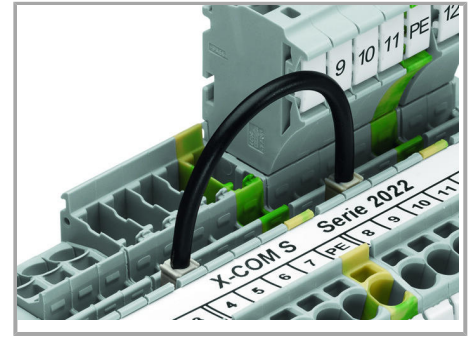

Commoning with push-in type wire jumper.

Testing

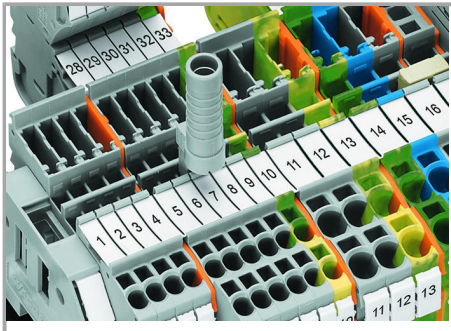

Test plug adapter (2009-174) for 4 mm test plugs or banana plugs – also suitable for X-COM®S-SYSTEM-MINI Terminal Blocks.

Coding

Subject to changes. Please also observe the further product documentation!

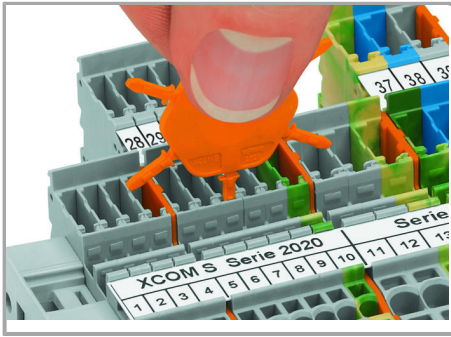

Insert coding pin into the corresponding slot and twist it off.



Coding a female plug: remove coding finger using a suitable tool.

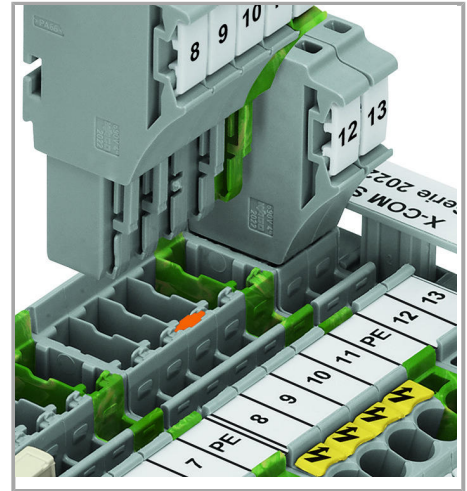

Insert a coding pin (2022-100) into the corresponding location of the carrier terminal block.

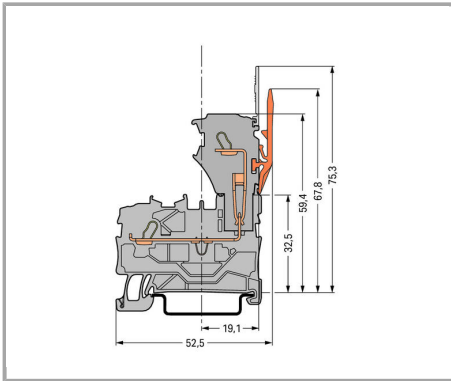

Carrier terminal block

Subject to changes. Please also observe the further product documentation!

WAGO Kontakttechnik GmbH & Co. KG
Hansastr. 27
32423 Minden
Phone: +49571 887-0 | Fax: +49571 887-169
Email: info.de@wago.com | Web: www.wago.com

Do you have any questions about our products?
We are always happy to take your call at +49 (571) 887-44222.

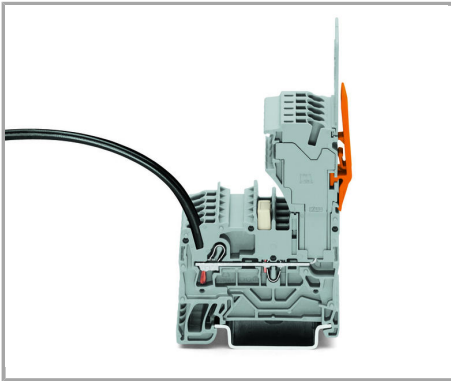

1-conductor female plug

Carrier terminal blocks can be commoned via 2000 Series Push-In Type Jumper Bars and tested via 859-500 Test Pin.

Marking

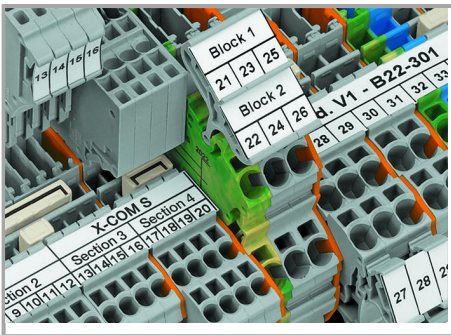

Clear marking via large marking area

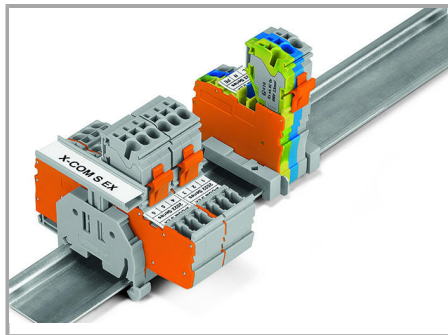

Group marking with height-adjustable group marker carrier (2009 163)

Subject to changes. Please also observe the further product documentation!

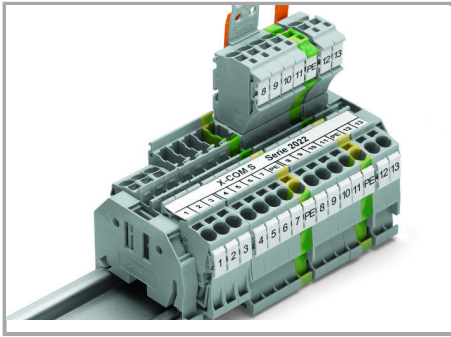

2022 Series X-COM®S-SYSTEM Carrier
Terminal Blocks combined with 2002 Series
Through Terminal Blocks

Safety

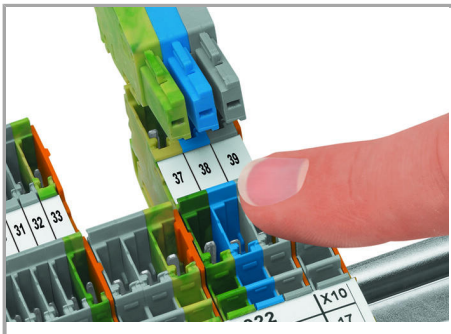

Carrier terminal blocks and female plugs are
touch-proof.

Product family

X-COM S

[Show all products from the family](#)

Subject to changes. Please also observe the further product documentation!