

Data sheet | Item number: 2022-114/000-006

1-conductor female plug; 2.5 mm<sup>2</sup>; 14-pole; 2,50 mm<sup>2</sup>; blue

[www.wago.com/2022-114/000-006](http://www.wago.com/2022-114/000-006)

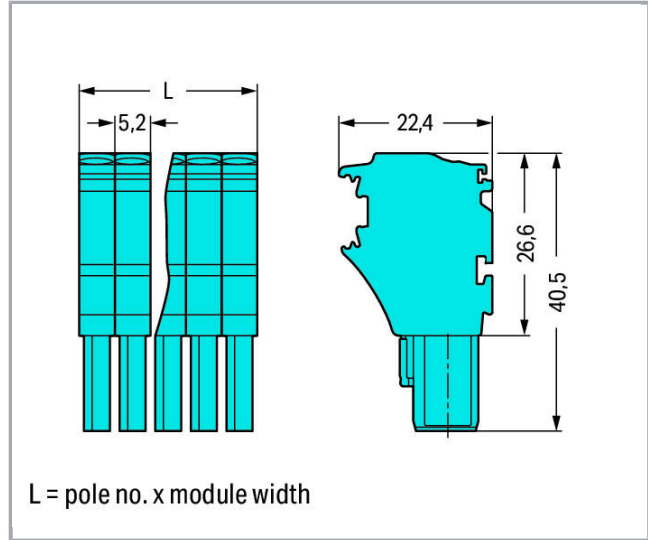

Subject to changes. Please also observe the further product documentation!

WAGO Kontakttechnik GmbH & Co. KG  
Hansastr. 27  
32423 Minden  
Phone: +49571 887-0 | Fax: +49571 887-169  
Email: [info.de@wago.com](mailto:info.de@wago.com) | Web: [www.wago.com](http://www.wago.com)

Do you have any questions about our products?  
We are always happy to take your call at +49 (571) 887-44222.



Subject to changes. Please also observe the further product documentation!

WAGO Kontakttechnik GmbH & Co. KG  
Hansastr. 27  
32423 Minden  
Phone: +49571 887-0 | Fax: +49571 887-169  
Email: [info.de@wago.com](mailto:info.de@wago.com) | Web: [www.wago.com](http://www.wago.com)

Do you have any questions about our products?  
We are always happy to take your call at +49 (571) 887-44222.

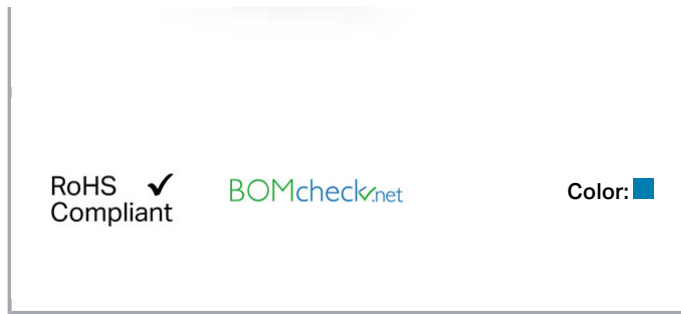

## Item description

### Safety information 1:

According to EN 61984, pluggable connectors without current interrupting capacity shall not be mated and unmated when live or under load.

## Data

### Electrical data

#### Ratings per IEC/EN 60664-1

Ratings per	IEC/EN 61984
Rated voltage (III / 3)	690 V
Rated impulse voltage (III / 3)	6 kV
Rated current	24 A
Rated current (2)	32 A
Legend (ratings)	(III / 3) ≙ Overvoltage category III / Pollution degree 3

### Connection data

Connection technology	Push-in CAGE CLAMP®
Actuation type	Open Tool Slot Push-in
Connectable conductor materials	Copper
Nominal cross section	2.5 mm <sup>2</sup>
Solid conductor	0.25 ... 4 mm <sup>2</sup> / 22 ... 12 AWG
Solid conductor, push-in termination	0.75 ... 4 mm <sup>2</sup> / 18 ... 12 AWG
Fine-stranded conductor	0.25 ... 4 mm <sup>2</sup> / 22 ... 12 AWG
Fine-stranded conductor with ferrule with plastic collar	1 ... 2.5 mm <sup>2</sup> / 18 ... 12 AWG
Fine-stranded conductor with ferrule, push-in termination, from	1 ... 2.5 mm <sup>2</sup> / 18 ... 12 AWG
Strip length	10 ... 12 mm / 0.39 ... 0.47 inch
No. of poles	14
Total number of connection points	14

Subject to changes. Please also observe the further product documentation!



Total number of potentials	14
Type of wiring	Front-entry wiring
Note (conductor cross-section)	Depending on the conductor characteristic, a conductor with a smaller cross section can also be inserted via push-in termination.

### Geometrical Data

Width	72.8 mm / 2.866 inch
Height	40.5 mm / 1.594 inch
Depth	22.4 mm / 0.882 inch
Module width	5.2 mm / 0.205 inch

### Mechanical data

Marking level	Side marking
---------------	--------------

### Plug connection

Contact type (pluggable connector)	Female connector/socket
Connector connection type	for conductors

### Material Data

Color	blue
Insulating material	Polyamide 66 (PA 66)
Fire load	0.749 MJ
Weight	46 g

### Commercial data

Product Group	18 (X-COM-System)
Packaging type	BOX
Country of origin	DE
GTIN	4045454705558
Customs Tariff No.	85366990990

### Counterpart

### Compatible products

Subject to changes. Please also observe the further product documentation!

WAGO Kontakttechnik GmbH & Co. KG  
 Hansastr. 27  
 32423 Minden  
 Phone: +49571 887-0 | Fax: +49571 887-169  
 Email: [info.de@wago.com](mailto:info.de@wago.com) | Web: [www.wago.com](http://www.wago.com)

Do you have any questions about our products?  
 We are always happy to take your call at +49 (571) 887-44222.

## Strain relief plate



**Item no.: 734-430**  
Strain relief plate; gray

[www.wago.com/734-430](http://www.wago.com/734-430)

## Protective Warning Marker



**Item no.: 2002-115**  
Protective warning marker; with high-voltage symbol, black; for 5 terminal blocks; yellow

[www.wago.com/2002-115](http://www.wago.com/2002-115)

## Locking lever



**Item no.: 2022-151**  
Locking lever; can be snapped on 1-conductor female plugs; 2 poles and more; gray

[www.wago.com/2022-151](http://www.wago.com/2022-151)



**Item no.: 2022-152**  
Locking lever; can be snapped on 1-conductor female plugs; 2 poles and more; orange

[www.wago.com/2022-152](http://www.wago.com/2022-152)

## ferrule

**Item no.: 216-241**  
Ferrule; Sleeve for 0.5 mm<sup>2</sup> / 20 AWG; insulated; electro-tin plated; electrolytic copper; gastight crimped; acc. to DIN 46228, Part 4/09.90; white

[www.wago.com/216-241](http://www.wago.com/216-241)



**Item no.: 216-242**  
Ferrule; Sleeve for 0.75 mm<sup>2</sup> / 18 AWG; insulated; electro-tin plated; electrolytic copper; gastight crimped; acc. to DIN 46228, Part 4/09.90; gray

[www.wago.com/216-242](http://www.wago.com/216-242)



**Item no.: 216-243**  
Ferrule; Sleeve for 1 mm<sup>2</sup> / AWG 18; insulated; electro-tin plated; electrolytic copper; gastight crimped; acc. to DIN 46228, Part 4/09.90; red

[www.wago.com/216-243](http://www.wago.com/216-243)



**Item no.: 216-244**  
Ferrule; Sleeve for 1.5 mm<sup>2</sup> / AWG 16; insulated; electro-tin plated; electrolytic copper; gastight crimped; acc. to DIN 46228, Part 4/09.90; black

[www.wago.com/216-244](http://www.wago.com/216-244)



**Item no.: 216-246**  
Ferrule; Sleeve for 2.5 mm<sup>2</sup> / AWG 14; insulated; electro-tin plated; electrolytic copper; gastight crimped; acc. to DIN 46228, Part 4/09.90; blue

[www.wago.com/216-246](http://www.wago.com/216-246)



**Item no.: 216-262**  
Ferrule; Sleeve for 0.75 mm<sup>2</sup> / 18 AWG; insulated; electro-tin plated; electrolytic copper; gastight crimped; acc. to DIN 46228, Part 4/09.90; gray

[www.wago.com/216-262](http://www.wago.com/216-262)

**Item no.: 216-263**  
Ferrule; Sleeve for 1 mm<sup>2</sup> / AWG 18; insulated; electro-tin plated; electrolytic copper; gastight crimped; acc. to DIN 46228, Part 4/09.90; red

[www.wago.com/216-263](http://www.wago.com/216-263)







**Item no.: 216-264**  
Ferrule; Sleeve for 1.5 mm<sup>2</sup> / AWG 16; insulated; electro-tin plated; electrolytic copper; gastight crimped; acc. to DIN 46228, Part 4/09.90; black

[www.wago.com/216-264](http://www.wago.com/216-264)

**Item no.: 216-266**  
Ferrule; Sleeve for 2.5 mm<sup>2</sup> / AWG 14; insulated; electro-tin plated; electrolytic copper; gastight crimped; acc. to DIN 46228, Part 4/09.90; blue

[www.wago.com/216-266](http://www.wago.com/216-266)

Subject to changes. Please also observe the further product documentation!

	<b>Item no.: 216-284</b> Ferrule; Sleeve for 1.5 mm <sup>2</sup> / AWG 16; insulated; electro-tin plated; electrolytic copper; gastight crimped; acc. to DIN 46228, Part 4/09.90; black	<a href="http://www.wago.com/216-284">www.wago.com/216-284</a>
	<b>Item no.: 216-286</b> Ferrule; Sleeve for 2.5 mm <sup>2</sup> / AWG 14; insulated; electro-tin plated; electrolytic copper; gastight crimped; acc. to DIN 46228, Part 4/09.90; blue	<a href="http://www.wago.com/216-286">www.wago.com/216-286</a>
<b>tools</b>		
	<b>Item no.: 210-720</b> Operating tool; Blade: 3.5 x 0.5 mm; with a partially insulated shaft	<a href="http://www.wago.com/210-720">www.wago.com/210-720</a>
<b>Insulation stop</b>		
	<b>Item no.: 2002-171</b> Insulation stop; 0.25 - 0.5 mm <sup>2</sup> ; 5 pieces/strip; light gray	<a href="http://www.wago.com/2002-171">www.wago.com/2002-171</a>
	<b>Item no.: 2002-172</b> Insulation stop; 0.75 - 1 mm <sup>2</sup> ; 5 pieces/strip; dark gray	<a href="http://www.wago.com/2002-172">www.wago.com/2002-172</a>
<b>Marking accessories</b>		
	<b>Item no.: 2009-110</b> Marking strips; on reel; not stretchable; plain; snap-on type; white	<a href="http://www.wago.com/2009-110">www.wago.com/2009-110</a>
	<b>Item no.: 2009-115</b> WMB-Inline; for Smart Printer; 1500 pieces on roll; stretchable 5 - 5.2 mm; plain; snap-on type; white	<a href="http://www.wago.com/2009-115">www.wago.com/2009-115</a>
	<b>Item no.: 2009-115/000-002</b> WMB-Inline; for Smart Printer; 1500 pieces on roll; stretchable 5 - 5.2 mm; plain; snap-on type; yellow	<a href="http://www.wago.com/2009-115/000-002">www.wago.com/2009-115/000-002</a>
	<b>Item no.: 2009-115/000-006</b> WMB-Inline; for Smart Printer; 1500 pieces on roll; stretchable 5 - 5.2 mm; plain; snap-on type; white	<a href="http://www.wago.com/2009-115/000-006">www.wago.com/2009-115/000-006</a>
	<b>Item no.: 2009-115/000-007</b> WMB-Inline; for Smart Printer; 1500 pieces on roll; stretchable 5 - 5.2 mm; plain; snap-on type; gray	<a href="http://www.wago.com/2009-115/000-007">www.wago.com/2009-115/000-007</a>
	<b>Item no.: 2009-115/000-012</b> WMB-Inline; for Smart Printer; 1500 pieces on roll; stretchable 5 - 5.2 mm; plain; snap-on type; white	<a href="http://www.wago.com/2009-115/000-012">www.wago.com/2009-115/000-012</a>
	<b>Item no.: 2009-115/000-017</b> WMB-Inline; for Smart Printer; 1500 pieces on roll; stretchable 5 - 5.2 mm; plain; snap-on type; white	<a href="http://www.wago.com/2009-115/000-017">www.wago.com/2009-115/000-017</a>
	<b>Item no.: 2009-115/000-023</b> WMB-Inline; for Smart Printer; 1500 pieces on roll; stretchable 5 - 5.2 mm; plain; snap-on type; green	<a href="http://www.wago.com/2009-115/000-023">www.wago.com/2009-115/000-023</a>
	<b>Item no.: 2009-115/000-024</b> WMB-Inline; for Smart Printer; 1500 pieces on roll; stretchable 5 - 5.2 mm; plain; snap-on type; white	<a href="http://www.wago.com/2009-115/000-024">www.wago.com/2009-115/000-024</a>

Subject to changes. Please also observe the further product documentation!



**Item no.: 2009-135**

WMB-Inline; for Smart Printer; on reel; stretchable 5 - 5.2 mm; plain; snap-on type; white

[www.wago.com/2009-135](http://www.wago.com/2009-135)



**Item no.: 210-805**

Labels; for Smart Printer; permanent adhesive; 6 x 15 mm; white

[www.wago.com/210-805](http://www.wago.com/210-805)



**Item no.: 210-805/000-002**

Labels; for Smart Printer; permanent adhesive; 6 x 15 mm; yellow

[www.wago.com/210-805/000-002](http://www.wago.com/210-805/000-002)



**Item no.: 210-831**

Marking strips; on reel; 2.3 mm wide; plain; Self-adhesive; white

[www.wago.com/210-831](http://www.wago.com/210-831)



**Item no.: 210-832**

Marking strips; on reel; 3 mm wide; plain; Self-adhesive; white

[www.wago.com/210-832](http://www.wago.com/210-832)



**Item no.: 210-833**

Marking strips; on reel; 6 mm wide; plain; Self-adhesive; white

[www.wago.com/210-833](http://www.wago.com/210-833)

**Item no.: 210-834**

Marking strips; on reel; 5 mm wide; plain; Self-adhesive; white

[www.wago.com/210-834](http://www.wago.com/210-834)



**Item no.: 793-5501**

WMB marking card; as card; for terminal block width 5 - 17.5 mm; stretchable 5 - 5.2 mm; plain; snap-on type; white

[www.wago.com/793-5501](http://www.wago.com/793-5501)



**Item no.: 793-5501/000-002**

WMB marking card; as card; for terminal block width 5 - 17.5 mm; stretchable 5 - 5.2 mm; plain; snap-on type; yellow

[www.wago.com/793-5501/000-002](http://www.wago.com/793-5501/000-002)

**Item no.: 793-5501/000-005**

WMB marking card; as card; for terminal block width 5 - 17.5 mm; stretchable 5 - 5.2 mm; plain; snap-on type; red

[www.wago.com/793-5501/000-005](http://www.wago.com/793-5501/000-005)



**Item no.: 793-5501/000-006**

WMB marking card; as card; for terminal block width 5 - 17.5 mm; stretchable 5 - 5.2 mm; plain; snap-on type; blue

[www.wago.com/793-5501/000-006](http://www.wago.com/793-5501/000-006)



**Item no.: 793-5501/000-007**

WMB marking card; as card; for terminal block width 5 - 17.5 mm; stretchable 5 - 5.2 mm; plain; snap-on type; gray

[www.wago.com/793-5501/000-007](http://www.wago.com/793-5501/000-007)



**Item no.: 793-5501/000-012**

WMB marking card; as card; for terminal block width 5 - 17.5 mm; stretchable 5 - 5.2 mm; plain; snap-on type; orange

[www.wago.com/793-5501/000-012](http://www.wago.com/793-5501/000-012)



**Item no.: 793-5501/000-017**

WMB marking card; as card; for terminal block width 5 - 17.5 mm; stretchable 5 - 5.2 mm; plain; snap-on type; green

[www.wago.com/793-5501/000-017](http://www.wago.com/793-5501/000-017)



**Item no.: 793-5501/000-023**

WMB marking card; as card; for terminal block width 5 - 17.5 mm; stretchable 5 - 5.2 mm; plain; snap-on type; light green

[www.wago.com/793-5501/000-023](http://www.wago.com/793-5501/000-023)

Subject to changes. Please also observe the further product documentation!

WAGO Kontakttechnik GmbH & Co. KG

Hansastr. 27

32423 Minden

Phone: +49571 887-0 | Fax: +49571 887-169

Email: [info.de@wago.com](mailto:info.de@wago.com) | Web: [www.wago.com](http://www.wago.com)

Do you have any questions about our products?

We are always happy to take your call at +49 (571) 887-44222.

Item no.: 793-5501/000-024

WMB marking card; as card; for terminal block width 5 - 17.5 mm; stretchable 5 - 5.2 mm; plain; snap- /000-024 on type; violet

[www.wago.com/793-5501](http://www.wago.com/793-5501)

## Downloads

### Documentation

#### Additional Information

Technical explanations	Apr 3, 2019	pdf 2.1 MB	Download
------------------------	-------------	---------------	----------

## CAD/CAE-Data

### CAD data

2D/3D Models 2022-114/000-006	URL	Download
-------------------------------	-----	----------

### CAE data

EPLAN Data Portal 2022-114/000-006	URL	Download
------------------------------------	-----	----------

WSCAD Universe 2022-114/000-006	URL	Download
---------------------------------	-----	----------

## Installation Notes

### Coding

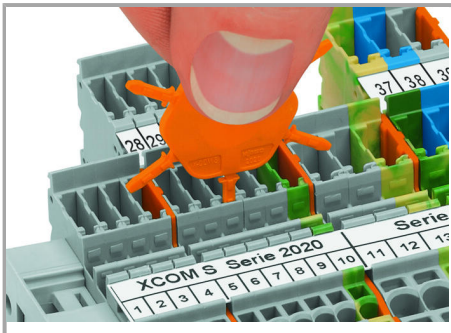

Insert coding pin into the corresponding slot and twist it off.



Coding a female plug: remove coding finger using a suitable tool.

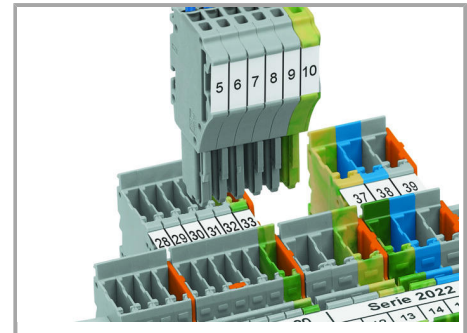

Insert coded female connector into X-COM®S-SYSTEM terminal block assembly.

### Locking lever

Subject to changes. Please also observe the further product documentation!



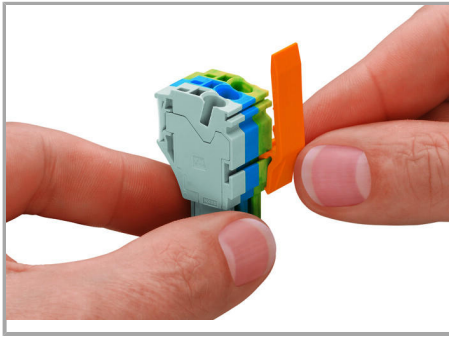

Slide the locking lever into position.

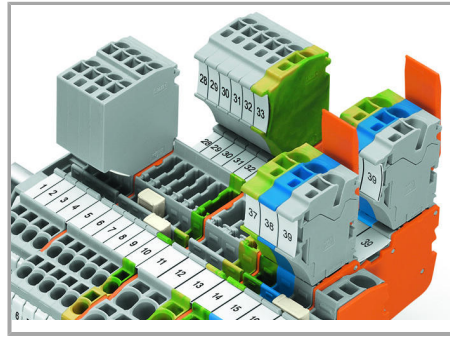

Female plugs can be individually locked.

## Product family

### X-COM S

[Show all products from the family](#)

Subject to changes. Please also observe the further product documentation!