

Data sheet | Item number: 2020-213

2-conductor female connector; 1.5 mm²; 13-pole; 1,50 mm²; gray

www.wago.com/2020-213

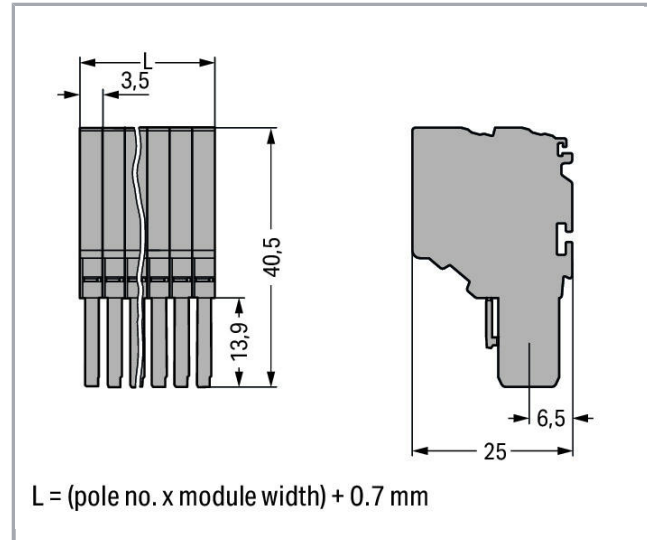
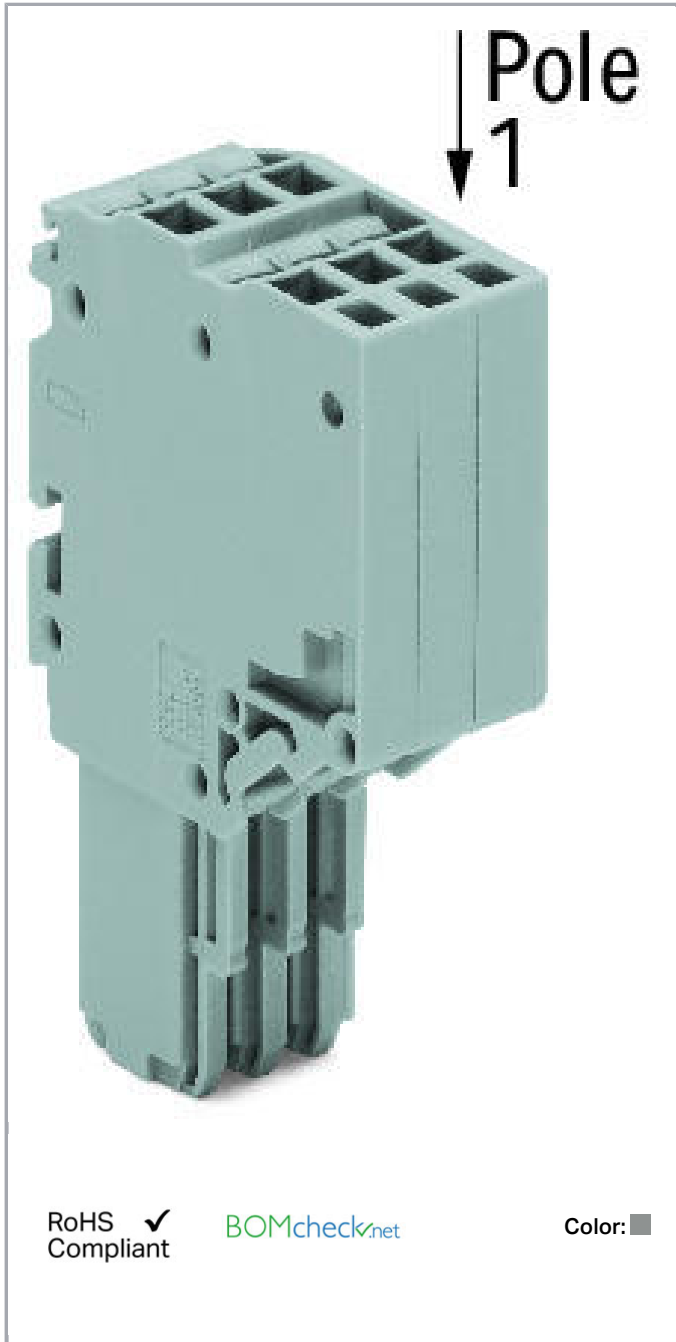

Subject to changes. Please also observe the further product documentation!

WAGO Kontakttechnik GmbH & Co. KG
Hansastr. 27
32423 Minden
Phone: +49571 887-0 | Fax: +49571 887-169
Email: info.de@wago.com | Web: www.wago.com

Do you have any questions about our products?
We are always happy to take your call at +49 (571) 887-44222.



Item description

Safety information 1:

According to EN 61984, pluggable connectors without current interrupting capacity shall not be mated and unmated when live or under load.

Safety information 2:

Notice: An appropriate end plate must be applied to the carrier terminal blocks after each female plug.

Data

Electrical data

Ratings per IEC/EN 60664-1

Ratings per	IEC/EN 61984
Rated voltage (III / 3)	500 V
Rated impulse voltage (III / 3)	6 kV
Rated current	13.5 A
Legend (ratings)	(III / 3) $\hat{=}$ Overvoltage category III / Pollution degree 3

Approvals per UL 1059

Rated voltage UL (Use Group B)	300 V
Rated current UL (Use Group B)	15 A
Rated voltage UL (Use Group C)	300 V
Rated current UL (Use Group C)	15 A
Rated voltage UL (Use Group D)	300 V
Rated current UL (Use Group D)	15 A
Approvals per	UL 1059

Approvals per CSA

Rated voltage CSA (Use Group B)	300 V
Rated current CSA (Use Group B)	10 A
Rated voltage CSA (Use Group C)	300 V
Rated current CSA (Use Group C)	10 A

Connection data

Connection technology	Push-in CAGE CLAMP®
Actuation type	Open Tool Slot Push-in
Connectable conductor materials	Copper

Subject to changes. Please also observe the further product documentation!



Nominal cross section	1 mm ²
Solid conductor	0,14 ... 1,5 mm ² / 24 ... 16 AWG
Solid conductor, push-in termination	0,5 ... 1,5 mm ² / 20 ... 16 AWG
Fine-stranded conductor	0,14 ... 1,5 mm ² / 24 ... 16 AWG
Fine-stranded conductor with ferrule with plastic collar	0,5 ... 0,75 mm ² / 20 ... 18 AWG
Fine-stranded conductor with ferrule, push-in termination, from	0,5 ... 0,75 mm ² / 20 ... 18 AWG
Strip length	9 ... 11 mm / 0.35 ... 0.43 inch
No. of poles	13
Total number of connection points	26
Total number of potentials	13
Type of wiring	Front-entry wiring
Note (conductor cross-section)	Depending on the conductor characteristic, a conductor with a smaller cross section can also be inserted via push-in termination.

Geometrical Data

Width	46,2 mm / 1.819 inch
Height	40,5 mm / 1.594 inch
Depth	25 mm / 0.984 inch
Module width	3,5 mm / 0.138 inch

Mechanical data

Marking level	Side marking
---------------	--------------

Plug connection

Contact type (pluggable connector)	Female connector/socket
Connector connection type	for conductors

Material Data

Color	gray
Insulating material	Polyamide 66 (PA 66)
Fire load	0.588 MJ
Weight	35.7 g

Commercial data

Product Group	18 (X-COM-System)
Packaging type	BOX

Subject to changes. Please also observe the further product documentation!



WAGO Kontakttechnik GmbH & Co. KG
 Hansastr. 27
 32423 Minden
 Phone: +49571 887-0 | Fax: +49571 887-169
 Email: info.de@wago.com | Web: www.wago.com

Do you have any questions about our products?
 We are always happy to take your call at +49 (571) 887-44222.



Country of origin	DE
GTIN	4045454855352
Customs Tariff No.	85366990990

Approvals / Certificates

Country specific Approvals

Logo	Approval	Additional Approval Text	Certificate name
	CCA DEKRA Certification B.V.	EN 60947	NTR NL 7617
	CSA DEKRA Certification B.V.	C22.2 No. 158	2516073

Ship Approvals

Logo	Approval	Additional Approval Text	Certificate name
	ABS American Bureau of Shipping	EN 60947	20- HG1941090- PDA
	BV Bureau Veritas S.A.	EN 60947	38586/A0 BV
	DNV GL Det Norske Veritas, Germanischer Lloyd	-	TAE00001V2
	LR Lloyds Register	EN 60947	91/20112 (E9)

UL-Approvals

Logo	Approval	Additional Approval Text	Certificate name
	UL UL International Germany GmbH	UL 1059	E45172



Subject to changes. Please also observe the further product documentation!





Counterpart

Compatible products

Strain relief plate

	Item no.: 734-326 Strain relief plate; gray	www.wago.com/734-326
	Item no.: 734-430 Strain relief plate; gray	www.wago.com/734-430
	Item no.: 734-431 Strain relief plate; gray	www.wago.com/734-431

ferrule

	Item no.: 216-241 Ferrule; Sleeve for 0.5 mm ² / 20 AWG; insulated; electro-tin plated; electrolytic copper; gastight crimped; acc. to DIN 46228, Part 4/09.90; white	www.wago.com/216-241
	Item no.: 216-242 Ferrule; Sleeve for 0.75 mm ² / 18 AWG; insulated; electro-tin plated; electrolytic copper; gastight crimped; acc. to DIN 46228, Part 4/09.90; gray	www.wago.com/216-242
	Item no.: 216-243 Ferrule; Sleeve for 1 mm ² / AWG 18; insulated; electro-tin plated; electrolytic copper; gastight crimped; acc. to DIN 46228, Part 4/09.90; red	www.wago.com/216-243

Locking lever







	Item no.: 2022-151 Locking lever; can be snapped on 1-conductor female plugs; 2 poles and more; gray	www.wago.com/2022-151
	Item no.: 2022-152 Locking lever; can be snapped on 1-conductor female plugs; 2 poles and more; orange	www.wago.com/2022-152

Protective Warning Marker

	Item no.: 2000-115 Protective warning marker; with high-voltage symbol, black; for 5 terminal blocks; yellow	www.wago.com/2000-115
--	--	--

Marking accessories

Subject to changes. Please also observe the further product documentation!

	<p>Item no.: 2009-113 WMB-Inline; for Smart Printer; 2300 pieces on roll; plain; snap-on type; white</p>	www.wago.com/2009-113
	<p>Item no.: 2009-113/000-002 WMB-Inline; for Smart Printer; 2300 pieces on roll; plain; snap-on type; yellow</p>	www.wago.com/2009-113/000-002
	<p>Item no.: 2009-113/000-005 WMB-Inline; for Smart Printer; 2300 pieces on roll; plain; snap-on type; red</p>	www.wago.com/2009-113/000-005
	<p>Item no.: 2009-113/000-006 WMB-Inline; for Smart Printer; 2300 pieces on roll; plain; snap-on type; blue</p>	www.wago.com/2009-113/000-006
	<p>Item no.: 2009-113/000-007 WMB-Inline; for Smart Printer; 2300 pieces on roll; plain; snap-on type; gray</p>	www.wago.com/2009-113/000-007
	<p>Item no.: 2009-113/000-012 WMB-Inline; for Smart Printer; 2300 pieces on roll; plain; snap-on type; orange</p>	www.wago.com/2009-113/000-012
	<p>Item no.: 2009-113/000-017 WMB-Inline; for Smart Printer; 2300 pieces on roll; plain; snap-on type; light green</p>	www.wago.com/2009-113/000-017
	<p>Item no.: 2009-113/000-023 WMB-Inline; for Smart Printer; 2300 pieces on roll; plain; snap-on type; green</p>	www.wago.com/2009-113/000-023
	<p>Item no.: 2009-113/000-024 WMB-Inline; for Smart Printer; 2300 pieces on roll; plain; snap-on type; violet</p>	www.wago.com/2009-113/000-024
	<p>Item no.: 793-3501 WMB marking card; as card; plain; snap-on type; white</p>	www.wago.com/793-3501
tools		
	<p>Item no.: 210-647 Operating tool; Blade: 2.5 x 0.4 mm; with a partially insulated shaft</p>	www.wago.com/210-647
	<p>Item no.: 210-648 Operating tool; Blade: 2.5 x 0.4 mm; with a partially insulated shaft; angled; short</p>	www.wago.com/210-648
	<p>Item no.: 210-719 Operating tool; Blade: 2.5 x 0.4 mm; with a partially insulated shaft</p>	www.wago.com/210-719

Downloads

Documentation

Additional Information

Subject to changes. Please also observe the further product documentation!

Technical explanations

Apr 3, 2019

pdf
2.1 MB

Download

CAD/CAE-Data

CAD data

2D/3D Models 2020-213

URL

Download

CAE data

EPLAN Data Portal 2020-213

URL

Download

WSCAD Universe 2020-213

URL

Download

Installation Notes

Coding

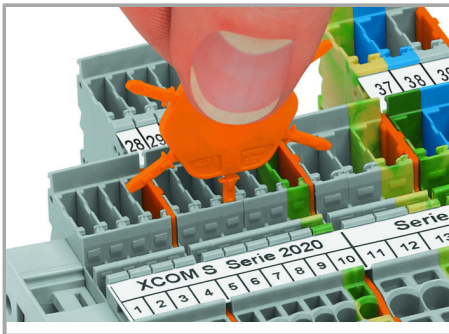

Insert coding pin into the corresponding slot and twist it off.



Coding a female plug: remove coding finger using a suitable tool.

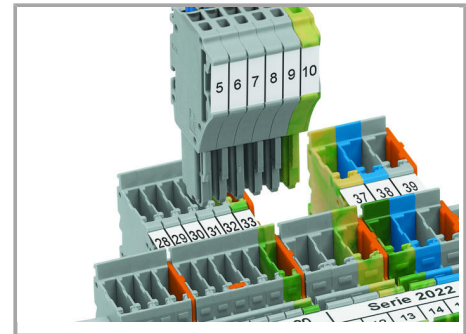

Insert coded female connector into X-COM®S-SYSTEM terminal block assembly.

Locking lever

Subject to changes. Please also observe the further product documentation!

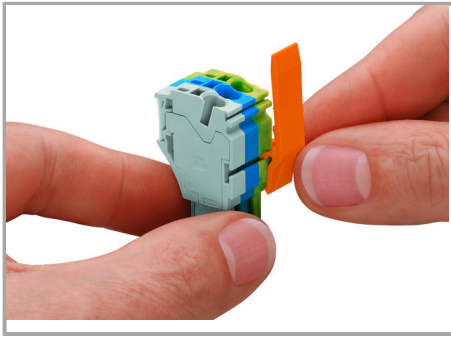

Slide the locking lever into position.

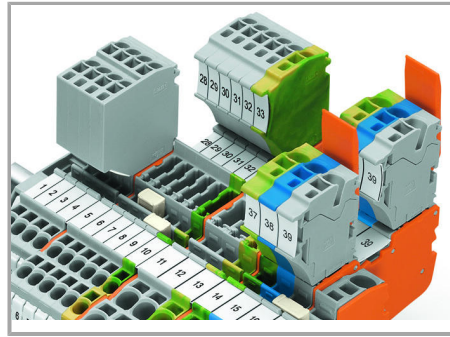

Female plugs can be individually locked.

Product family

X-COM S-Mini

[Show all products from the family](#)

Subject to changes. Please also observe the further product documentation!