

Data sheet | Item number: 2020-209

2-conductor female connector; 1.5 mm<sup>2</sup>; 9-pole; 1,50 mm<sup>2</sup>; gray

[www.wago.com/2020-209](http://www.wago.com/2020-209)

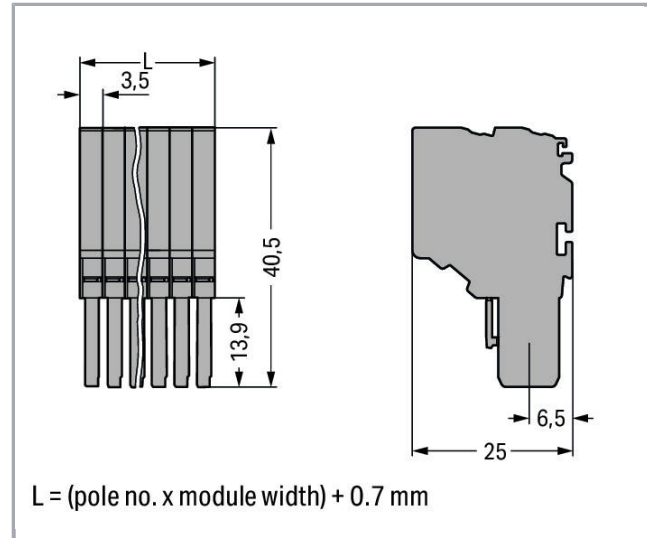
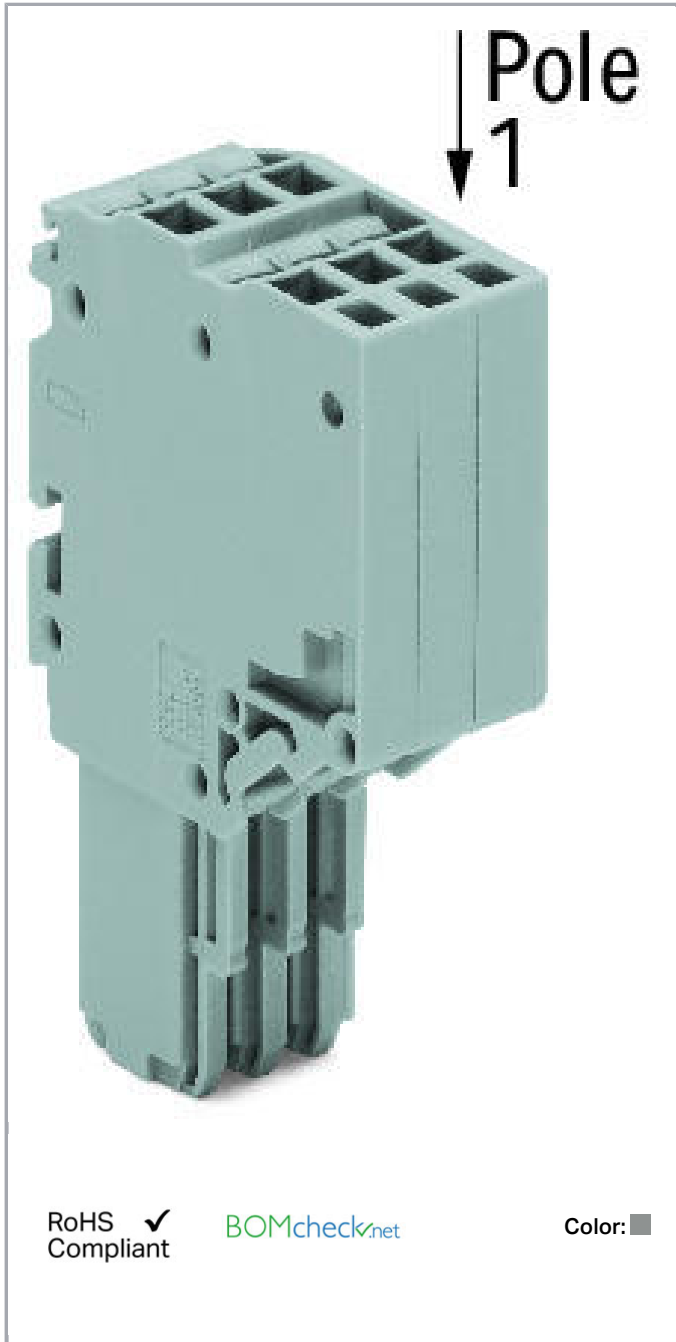

Subject to changes. Please also observe the further product documentation!

WAGO Kontakttechnik GmbH & Co. KG  
Hansastr. 27  
32423 Minden  
Phone: +49571 887-0 | Fax: +49571 887-169  
Email: [info.de@wago.com](mailto:info.de@wago.com) | Web: [www.wago.com](http://www.wago.com)

Do you have any questions about our products?  
We are always happy to take your call at +49 (571) 887-44222.



## Item description

### Safety information 1:

According to EN 61984, pluggable connectors without current interrupting capacity shall not be mated and unmated when live or under load.

### Safety information 2:

Notice: An appropriate end plate must be applied to the carrier terminal blocks after each female plug.

## Data

### Electrical data

#### Ratings per IEC/EN 60664-1

| Ratings per                     | IEC/EN 61984   |
|---------------------------------|--|
| Rated voltage (III / 3)         | 500 V  |
| Rated impulse voltage (III / 3) | 6 kV   |
| Rated current                   | 13.5 A   |
| Legend (ratings)                | (III / 3) $\triangleq$ Overvoltage category III / Pollution degree 3 |

#### Approvals per UL 1059

|                                |         |
|--------------------------------|---------|
| Rated voltage UL (Use Group B) | 300 V   |
| Rated current UL (Use Group B) | 15 A    |
| Rated voltage UL (Use Group C) | 300 V   |
| Rated current UL (Use Group C) | 15 A    |
| Rated voltage UL (Use Group D) | 300 V   |
| Rated current UL (Use Group D) | 15 A    |
| Approvals per                  | UL 1059 |

#### Approvals per CSA

|                                 |       |
|---------------------------------|-------|
| Rated voltage CSA (Use Group B) | 300 V |
| Rated current CSA (Use Group B) | 10 A  |
| Rated voltage CSA (Use Group C) | 300 V |
| Rated current CSA (Use Group C) | 10 A  |

## Connection data

|                                 |                           |
|---------------------------------|---------------------------|
| Connection technology           | Push-in CAGE CLAMP®       |
| Actuation type                  | Open Tool Slot<br>Push-in |
| Connectable conductor materials | Copper                    |

Subject to changes. Please also observe the further product documentation!



|   |   |
|---|---|
| Nominal cross section   | 1 mm <sup>2</sup>   |
| Solid conductor   | 0.14 ... 1.5 mm <sup>2</sup> / 24 ... 16 AWG  |
| Solid conductor, push-in termination                            | 0.5 ... 1.5 mm <sup>2</sup> / 20 ... 16 AWG   |
| Fine-stranded conductor   | 0.14 ... 1.5 mm <sup>2</sup> / 24 ... 16 AWG  |
| Fine-stranded conductor with ferrule with plastic collar        | 0.5 ... 0.75 mm <sup>2</sup> / 20 ... 18 AWG  |
| Fine-stranded conductor with ferrule, push-in termination, from | 0.5 ... 0.75 mm <sup>2</sup> / 20 ... 18 AWG  |
| Strip length  | 9 ... 11 mm / 0.35 ... 0.43 inch  |
| No. of poles  | 9   |
| Total number of connection points                               | 18  |
| Total number of potentials                                      | 9   |
| Type of wiring  | Front-entry wiring  |
| Note (conductor cross-section)                                  | Depending on the conductor characteristic, a conductor with a smaller cross section can also be inserted via push-in termination. |

### Geometrical Data

|              |                      |
|--------------|----------------------|
| Width        | 32.2 mm / 1.268 inch |
| Height       | 40.5 mm / 1.594 inch |
| Depth        | 25 mm / 0.984 inch   |
| Module width | 3.5 mm / 0.138 inch  |

### Mechanical data

|               |              |
|---------------|--------------|
| Marking level | Side marking |
|---------------|--------------|

### Plug connection

|                                    |                         |
|------------------------------------|-------------------------|
| Contact type (pluggable connector) | Female connector/socket |
| Connector connection type          | for conductors          |

### Material Data

|                     |                      |
|---------------------|----------------------|
| Color               | gray                 |
| Insulating material | Polyamide 66 (PA 66) |
| Fire load           | 0.412 MJ             |
| Weight              | 24.7 g               |

### Commercial data

|                |                   |
|----------------|-------------------|
| Product Group  | 18 (X-COM-System) |
| Packaging type | BOX               |

Subject to changes. Please also observe the further product documentation!



WAGO Kontakttechnik GmbH & Co. KG  
 Hansastr. 27  
 32423 Minden  
 Phone: +49571 887-0 | Fax: +49571 887-169  
 Email: [info.de@wago.com](mailto:info.de@wago.com) | Web: [www.wago.com](http://www.wago.com)

Do you have any questions about our products?  
 We are always happy to take your call at +49 (571) 887-44222.



|                    |               |
|--------------------|---------------|
| Country of origin  | DE            |
| GTIN               | 4045454855314 |
| Customs Tariff No. | 85366990990   |

## Approvals / Certificates

### Country specific Approvals

| Logo   | Approval                               | Additional Approval Text | Certificate name |
|--|--|--------------------------|------------------|
|  | <b>CCA</b><br>DEKRA Certification B.V. | EN 60947                 | NTR NL<br>7617   |
|  | <b>CSA</b><br>DEKRA Certification B.V. | C22.2 No. 158            | 2516073          |

### Ship Approvals

| Logo  | Approval  | Additional Approval Text | Certificate name         |
|---|---|--------------------------|--------------------------|
|    | <b>ABS</b><br>American Bureau of Shipping               | EN 60947                 | 20-<br>HG1941090-<br>PDA |
|  | <b>BV</b><br>Bureau Veritas S.A.                        | EN 60947                 | 38586/A0 BV              |
|   | <b>DNV GL</b><br>Det Norske Veritas, Germanischer Lloyd | -                        | TAE00001V2               |
|  | <b>LR</b><br>Lloyds Register                            | EN 60947                 | 91/20112<br>(E9)         |

### UL-Approvals

| Logo | Approval                                   | Additional Approval Text | Certificate name |
|------|--|--------------------------|------------------|
|      | <b>UL</b><br>UL International Germany GmbH | UL 1059                  | E45172           |

Subject to changes. Please also observe the further product documentation!



## Counterpart

## Compatible products

### Locking lever

|  |  |
|--|--|
| <b>Item no.: 2022-151</b><br>Locking lever; can be snapped on 1-conductor female plugs; 2 poles and more; gray | <a href="http://www.wago.com/2022-151">www.wago.com/2022-151</a> |
|--|--|



|  |  |
|--|--|
| <b>Item no.: 2022-152</b><br>Locking lever; can be snapped on 1-conductor female plugs; 2 poles and more; orange | <a href="http://www.wago.com/2022-152">www.wago.com/2022-152</a> |
|--|--|

### ferrule

|  |  |
|--|--|
| <b>Item no.: 216-241</b><br>Ferrule; Sleeve for 0.5 mm <sup>2</sup> / 20 AWG; insulated; electro-tin plated; electrolytic copper; gastight crimped; acc. to DIN 46228, Part 4/09.90; white | <a href="http://www.wago.com/216-241">www.wago.com/216-241</a> |
|--|--|



|  |  |
|--|--|
| <b>Item no.: 216-242</b><br>Ferrule; Sleeve for 0.75 mm <sup>2</sup> / 18 AWG; insulated; electro-tin plated; electrolytic copper; gastight crimped; acc. to DIN 46228, Part 4/09.90; gray | <a href="http://www.wago.com/216-242">www.wago.com/216-242</a> |
|--|--|



|  |  |
|--|--|
| <b>Item no.: 216-243</b><br>Ferrule; Sleeve for 1 mm <sup>2</sup> / AWG 18; insulated; electro-tin plated; electrolytic copper; gastight crimped; acc. to DIN 46228, Part 4/09.90; red | <a href="http://www.wago.com/216-243">www.wago.com/216-243</a> |
|--|--|

### tools

|   |  |
|---|--|
| <b>Item no.: 210-647</b><br>Operating tool; Blade: 2.5 x 0.4 mm; with a partially insulated shaft | <a href="http://www.wago.com/210-647">www.wago.com/210-647</a> |
|---|--|



|  |  |
|--|--|
| <b>Item no.: 210-648</b><br>Operating tool; Blade: 2.5 x 0.4 mm; with a partially insulated shaft; angled; short | <a href="http://www.wago.com/210-648">www.wago.com/210-648</a> |
|--|--|







|   |  |
|---|--|
| <b>Item no.: 210-719</b><br>Operating tool; Blade: 2.5 x 0.4 mm; with a partially insulated shaft | <a href="http://www.wago.com/210-719">www.wago.com/210-719</a> |
|---|--|

### Marking accessories



|   |  |
|---|--|
| <b>Item no.: 2009-113</b><br>WMB-Inline; for Smart Printer; 2300 pieces on roll; plain; snap-on type; white | <a href="http://www.wago.com/2009-113">www.wago.com/2009-113</a> |
|---|--|

Subject to changes. Please also observe the further product documentation!

|  |   |  |
|--|---|--|
|   | <b>Item no.: 2009-113/000-002</b><br>WMB-Inline; for Smart Printer; 2300 pieces on roll; plain; snap-on type; yellow      | <a href="http://www.wago.com/2009-113/000-002">www.wago.com/2009-113/000-002</a> |
|   | <b>Item no.: 2009-113/000-005</b><br>WMB-Inline; for Smart Printer; 2300 pieces on roll; plain; snap-on type; red         | <a href="http://www.wago.com/2009-113/000-005">www.wago.com/2009-113/000-005</a> |
|  | <b>Item no.: 2009-113/000-006</b><br>WMB-Inline; for Smart Printer; 2300 pieces on roll; plain; snap-on type; blue        | <a href="http://www.wago.com/2009-113/000-006">www.wago.com/2009-113/000-006</a> |
|   | <b>Item no.: 2009-113/000-007</b><br>WMB-Inline; for Smart Printer; 2300 pieces on roll; plain; snap-on type; gray        | <a href="http://www.wago.com/2009-113/000-007">www.wago.com/2009-113/000-007</a> |
|  | <b>Item no.: 2009-113/000-012</b><br>WMB-Inline; for Smart Printer; 2300 pieces on roll; plain; snap-on type; orange      | <a href="http://www.wago.com/2009-113/000-012">www.wago.com/2009-113/000-012</a> |
|   | <b>Item no.: 2009-113/000-017</b><br>WMB-Inline; for Smart Printer; 2300 pieces on roll; plain; snap-on type; light green | <a href="http://www.wago.com/2009-113/000-017">www.wago.com/2009-113/000-017</a> |
|   | <b>Item no.: 2009-113/000-023</b><br>WMB-Inline; for Smart Printer; 2300 pieces on roll; plain; snap-on type; green       | <a href="http://www.wago.com/2009-113/000-023">www.wago.com/2009-113/000-023</a> |
|  | <b>Item no.: 2009-113/000-024</b><br>WMB-Inline; for Smart Printer; 2300 pieces on roll; plain; snap-on type; violet      | <a href="http://www.wago.com/2009-113/000-024">www.wago.com/2009-113/000-024</a> |
|  | <b>Item no.: 793-3501</b><br>WMB marking card; as card; plain; snap-on type; white  | <a href="http://www.wago.com/793-3501">www.wago.com/793-3501</a>                 |

**Strain relief plate**

|   |  |
|---|--|
| <b>Item no.: 734-329</b><br>Strain relief plate; gray | <a href="http://www.wago.com/734-329">www.wago.com/734-329</a> |
|---|--|

**Protective Warning Marker**

|  |  |
|--|--|
| <b>Item no.: 2000-115</b><br>Protective warning marker; with high-voltage symbol, black; for 5 terminal blocks; yellow | <a href="http://www.wago.com/2000-115">www.wago.com/2000-115</a> |
|--|--|

**Downloads**

**Documentation**

**Additional Information**

|                        |             |               |          |
|------------------------|-------------|---------------|----------|
| Technical explanations | Apr 3, 2019 | pdf<br>2.1 MB | Download |
|------------------------|-------------|---------------|----------|

Subject to changes. Please also observe the further product documentation!

## CAD/CAE-Data

### CAD data

2D/3D Models 2020-209

[URL](#)

[Download](#)

### CAE data

EPLAN Data Portal 2020-209

[URL](#)

[Download](#)

WSCAD Universe 2020-209

[URL](#)

[Download](#)

## Installation Notes

### Coding

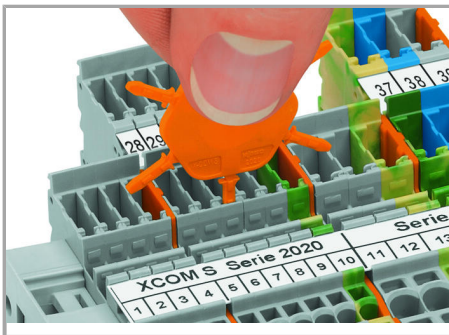

Insert coding pin into the corresponding slot and twist it off.



Coding a female plug: remove coding finger using a suitable tool.

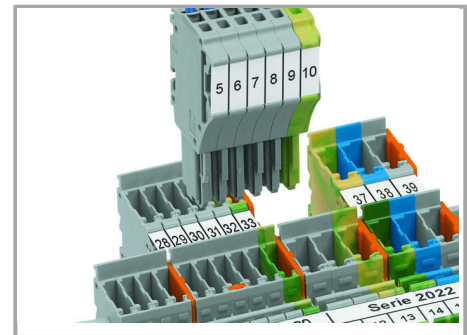

Insert coded female connector into X-COM®S-SYSTEM terminal block assembly.

### Locking lever

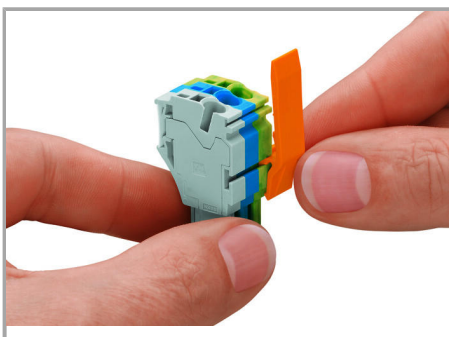

Slide the locking lever into position.

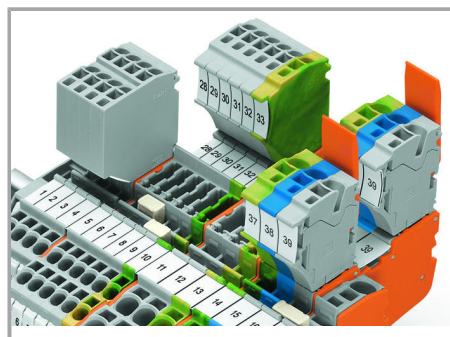

Female plugs can be individually locked.

## Product family

Subject to changes. Please also observe the further product documentation!



**X-COM S-Mini**

[Show all products from the family](#)

Subject to changes. Please also observe the further product documentation!

---

WAGO Kontakttechnik GmbH & Co. KG  
Hansastr. 27  
32423 Minden  
Phone: +49571 887-0 | Fax: +49571 887-169  
Email: [info.de@wago.com](mailto:info.de@wago.com) | Web: [www.wago.com](http://www.wago.com)

Do you have any questions about our products?  
We are always happy to take your call at +49 (571) 887-44222.