

Data sheet | Item number: 2020-1401

2-conductor/2-pin carrier terminal block; for DIN-rail 35 x 15 and 35 x 7.5;
Push-in CAGE CLAMP®; 1,00 mm²; gray

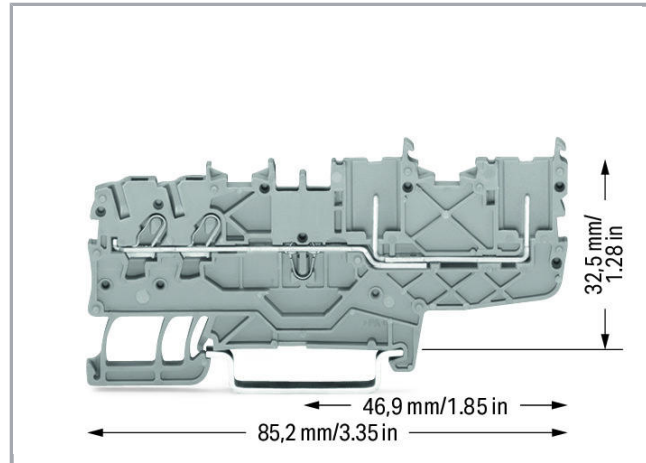

www.wago.com/2020-1401

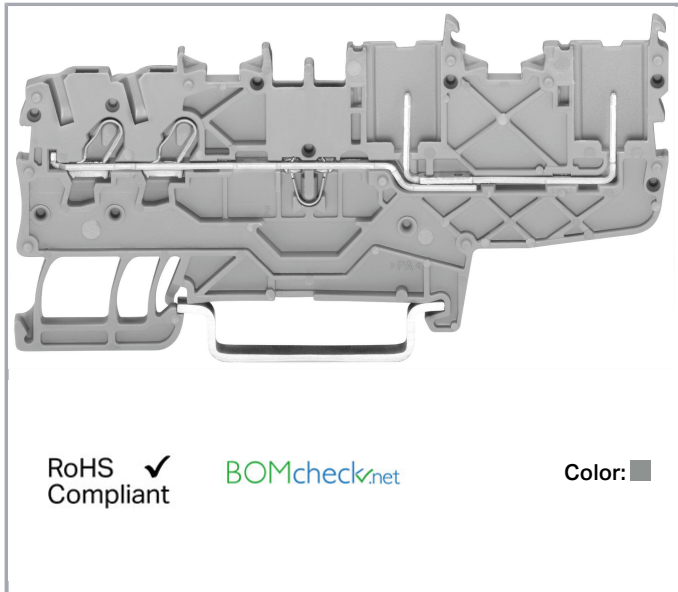

Data

Electrical data

Ratings per IEC/EN 60664-1

Ratings per	IEC/EN 60947-7-1
Rated voltage (III / 3)	500 V
Rated impulse voltage (III / 3)	6 kV
Rated current	13.5 A
Legend (ratings)	(III / 3) ≙ Overvoltage category III / Pollution degree 3

Approvals per UL 1059

Rated voltage UL (Use Group B)	300 V
Rated current UL (Use Group B)	15 A
Rated voltage UL (Use Group C)	300 V
Rated current UL (Use Group C)	15 A
Rated voltage UL (Use Group D)	300 V
Rated current UL (Use Group D)	15 A
Approvals per	UL 1059

Subject to changes. Please also observe the further product documentation!

WAGO Kontakttechnik GmbH & Co. KG
Hansastr. 27
32423 Minden
Phone: +49571 887-0 | Fax: +49571 887-169
Email: info.de@wago.com | Web: www.wago.com

Do you have any questions about our products?
We are always happy to take your call at +49 (571) 887-44222.



Approvals per CSA

Rated voltage CSA (Use Group B)	300 V
Rated current CSA (Use Group B)	10 A
Rated voltage CSA (Use Group C)	300 V
Rated current CSA (Use Group C)	10 A

Connection data

Connection technology	Push-in CAGE CLAMP®
Actuation type	Open Tool Slot Push-in
Connectable conductor materials	Copper
Nominal cross section	1 mm ²
Solid conductor	0,14 ... 1,5 mm ² / 24 ... 16 AWG
Solid conductor, push-in termination	0,5 ... 1,5 mm ² / 20 ... 16 AWG
Fine-stranded conductor	0,14 ... 1,5 mm ² / 24 ... 16 AWG
Fine-stranded conductor with ferrule with plastic collar	0,5 ... 0,75 mm ² / 20 ... 18 AWG
Fine-stranded conductor with ferrule, push-in termination, from	0,5 ... 0,75 mm ² / 20 ... 18 AWG
Strip length	9 ... 11 mm / 0.35 ... 0.43 inch
Total number of connection points	2
Total number of potentials	1
Number of levels	1
Type of wiring	Front-entry wiring
Note (conductor cross-section)	Depending on the conductor characteristic, a conductor with a smaller cross section can also be inserted via push-in termination.

Geometrical Data

Width	3,5 mm / 0.138 inch
Height from upper-edge of DIN-35 rail	32,5 mm / 1.28 inch
Depth	85,2 mm / 3.354 inch

Mechanical data

Design	horizontal
Type of mounting	DIN-35 rail
Marking level	Center/side marking

Subject to changes. Please also observe the further product documentation!

WAGO Kontakttechnik GmbH & Co. KG
 Hansastr. 27
 32423 Minden
 Phone: +49571 887-0 | Fax: +49571 887-169
 Email: info.de@wago.com | Web: www.wago.com

Do you have any questions about our products?
 We are always happy to take your call at +49 (571) 887-44222.

Material Data



Color	gray
Insulating material	Polyamide 66 (PA 66)
Fire load	0.136 MJ
Weight	6.6 g

Commercial data

Product Group	18 (X-COM-System)
Packaging type	BOX
Country of origin	CN
GTIN	4050821145301
Customs Tariff No.	85366990990

Approvals / Certificates

Country specific Approvals

Logo	Approval	Additional Approval Text	Certificate name
	CCA DEKRA Certification B.V.	EN 60947	NTR NL 7617
	CSA DEKRA Certification B.V.	C22.2 No. 158	2516073
	KEMA/KEUR DEKRA Certification B.V.	EN 60947	71- 100670

Ship Approvals

Logo	Approval	Additional Approval Text	Certificate name
	ABS American Bureau of Shipping	EN 60947	20- HG1941090- PDA
	BV Bureau Veritas S.A.	EN 60947	38586/A0 BV

Subject to changes. Please also observe the further product documentation!



BUREAU
VERITAS

DNV GL

Det Norske Veritas, Germanischer Lloyd

-

TAE00001V2



LR

Lloyds Register

EN 60947

91/20112
(E9)

UL-Approvals

Logo	Approval	Additional Approval Text	Certificate name
	UL UL International Germany GmbH	UL 1059	E45172

Counterpart

Compatible products

Coding



Item no.: 2020-100

Carrier with 6 coding pins; for coding of female plugs; for carrier terminal blocks; orange

www.wago.com/2020-100

Carrier rail

Item no.: 210-112

Steel carrier rail; 35 x 7.5 mm; 1 mm thick; 2 m long; slotted; according to EN 60715; "Hole width 25 mm

www.wago.com/210-112

Subject to changes. Please also observe the further product documentation!

WAGO Kontakttechnik GmbH & Co. KG

Hansastr. 27









32423 Minden

Phone: +49571 887-0 | Fax: +49571 887-169













Email: info.de@wago.com | Web: www.wago.com

Do you have any questions about our products?















We are always happy to take your call at +49 (571) 887-44222.

	Item no.: 210-113 Steel carrier rail; 35 x 7.5 mm; 1 mm thick; 2 m long; unslotted; according to EN 60715	www.wago.com/210-113
	Item no.: 210-114 Steel carrier rail; 35 x 15 mm; 1.5 mm thick; 2 m long; unslotted; similar to EN 60715	www.wago.com/210-114
	Item no.: 210-115 Steel carrier rail; 35 x 7.5 mm; 1 mm thick; 2 m long; slotted; according to EN 60715; "Hole width 18 mm	www.wago.com/210-115
	Item no.: 210-118 Steel carrier rail; 35 x 15 mm; 2.3 mm thick; 2 m long; unslotted; according to EN 60715	www.wago.com/210-118
	Item no.: 210-196 Aluminum carrier rail; 35 x 8.2 mm; 1.6 mm thick; 2 m long; unslotted; similar to EN 60715; silver-colored	www.wago.com/210-196
	Item no.: 210-197 Steel carrier rail; 35 x 15 mm; 1.5 mm thick; 2 m long; slotted; similar to EN 60715	www.wago.com/210-197
	Item no.: 210-198 Copper carrier rail; 35 x 15 mm; 2.3 mm thick; 2 m long; unslotted; according to EN 60715; copper-colored	www.wago.com/210-198
Marking accessories		
	Item no.: 2009-110 Marking strips; on reel; not stretchable; plain; snap-on type; white	www.wago.com/2009-110
	Item no.: 2009-113 WMB-Inline; for Smart Printer; 2300 pieces on roll; plain; snap-on type; white	www.wago.com/2009-113
	Item no.: 2009-113/000-002 WMB-Inline; for Smart Printer; 2300 pieces on roll; plain; snap-on type; yellow	www.wago.com/2009-113/000-002
	Item no.: 2009-113/000-005 WMB-Inline; for Smart Printer; 2300 pieces on roll; plain; snap-on type; red	www.wago.com/2009-113/000-005
	Item no.: 2009-113/000-006 WMB-Inline; for Smart Printer; 2300 pieces on roll; plain; snap-on type; blue	www.wago.com/2009-113/000-006
	Item no.: 2009-113/000-007 WMB-Inline; for Smart Printer; 2300 pieces on roll; plain; snap-on type; gray	www.wago.com/2009-113/000-007
	Item no.: 2009-113/000-012 WMB-Inline; for Smart Printer; 2300 pieces on roll; plain; snap-on type; orange	www.wago.com/2009-113/000-012
	Item no.: 2009-113/000-017 WMB-Inline; for Smart Printer; 2300 pieces on roll; plain; snap-on type; light green	www.wago.com/2009-113/000-017















Subject to changes. Please also observe the further product documentation!

	<p>Item no.: 2009-113/000-023 WMB-Inline; for Smart Printer; 2300 pieces on roll; plain; snap-on type; green</p>	www.wago.com/2009-113/000-023
	<p>Item no.: 2009-113/000-024 WMB-Inline; for Smart Printer; 2300 pieces on roll; plain; snap-on type; violet</p>	www.wago.com/2009-113/000-024
	<p>Item no.: 793-3501 WMB marking card; as card; plain; snap-on type; white</p>	www.wago.com/793-3501
Jumper		
	<p>Item no.: 2000-402 Push-in type jumper bar; insulated; 2-way; Nominal current 14 A; light gray</p>	www.wago.com/2000-402
	<p>Item no.: 2000-402/000-005 Push-in type jumper bar; insulated; 2-way; Nominal current 14 A; red</p>	www.wago.com/2000-402/000-005
	<p>Item no.: 2000-402/000-006 Push-in type jumper bar; insulated; 2-way; Nominal current 14 A; blue</p>	www.wago.com/2000-402/000-006
	<p>Item no.: 2000-402/000-018 Push-in type jumper bar; insulated; 2-way; Nominal current 14 A; yellow-green</p>	www.wago.com/2000-402/000-018
	<p>Item no.: 2000-403 Push-in type jumper bar; insulated; 3-way; Nominal current 14 A; light gray</p>	www.wago.com/2000-403
	<p>Item no.: 2000-403/000-005 Push-in type jumper bar; insulated; 3-way; Nominal current 14 A; red</p>	www.wago.com/2000-403/000-005
	<p>Item no.: 2000-403/000-006 Push-in type jumper bar; insulated; 3-way; Nominal current 14 A; blue</p>	www.wago.com/2000-403/000-006
	<p>Item no.: 2000-404 Push-in type jumper bar; insulated; 4-way; Nominal current 14 A; light gray</p>	www.wago.com/2000-404
	<p>Item no.: 2000-404/000-005 Push-in type jumper bar; insulated; 4-way; Nominal current 14 A; red</p>	www.wago.com/2000-404/000-005
	<p>Item no.: 2000-404/000-006 Push-in type jumper bar; insulated; 4-way; Nominal current 14 A; blue</p>	www.wago.com/2000-404/000-006
	<p>Item no.: 2000-405 Push-in type jumper bar; insulated; 5-way; Nominal current 14 A; light gray</p>	www.wago.com/2000-405

Subject to changes. Please also observe the further product documentation!

	<p>Item no.: 2000-405/000-005 Push-in type jumper bar; insulated; 5-way; Nominal current 14 A; red</p>	www.wago.com/2000-405/000-005
	<p>Item no.: 2000-405/000-006 Push-in type jumper bar; insulated; 5-way; Nominal current 14 A; blue</p>	www.wago.com/2000-405/000-006
	<p>Item no.: 2000-405/011-000 Star point jumper; insulated; 3-way (1-3-5); IN = IN terminal block; light gray</p>	www.wago.com/2000-405/011-000
	<p>Item no.: 2000-406 Push-in type jumper bar; insulated; 6-way; Nominal current 14 A; light gray</p>	www.wago.com/2000-406
	<p>Item no.: 2000-406/000-005 Push-in type jumper bar; insulated; 6-way; Nominal current 14 A; red</p>	www.wago.com/2000-406/000-005
	<p>Item no.: 2000-406/000-006 Push-in type jumper bar; insulated; 6-way; Nominal current 14 A; blue</p>	www.wago.com/2000-406/000-006
	<p>Item no.: 2000-406/020-000 Delta jumper; insulated; 1-2 3-4 5-6; IN = IN terminal block; light gray</p>	www.wago.com/2000-406/020-000
	<p>Item no.: 2000-407 Push-in type jumper bar; insulated; 7-way; Nominal current 14 A; light gray</p>	www.wago.com/2000-407
	<p>Item no.: 2000-407/000-005 Push-in type jumper bar; insulated; 7-way; Nominal current 14 A; red</p>	www.wago.com/2000-407/000-005
	<p>Item no.: 2000-407/000-006 Push-in type jumper bar; insulated; 7-way; Nominal current 14 A; blue</p>	www.wago.com/2000-407/000-006
	<p>Item no.: 2000-408 Push-in type jumper bar; insulated; 8-way; Nominal current 14 A; light gray</p>	www.wago.com/2000-408
	<p>Item no.: 2000-408/000-005 Push-in type jumper bar; insulated; 8-way; Nominal current 14 A; red</p>	www.wago.com/2000-408/000-005
	<p>Item no.: 2000-408/000-006 Push-in type jumper bar; insulated; 8-way; Nominal current 14 A; blue</p>	www.wago.com/2000-408/000-006
	<p>Item no.: 2000-409 Push-in type jumper bar; insulated; 9-way; Nominal current 14 A; light gray</p>	www.wago.com/2000-409

Subject to changes. Please also observe the further product documentation!

	<p>Item no.: 2000-409/000-005 Push-in type jumper bar; insulated; 9-way; Nominal current 14 A; red</p>	www.wago.com/2000-409/000-005
	<p>Item no.: 2000-409/000-006 Push-in type jumper bar; insulated; 9-way; Nominal current 14 A; blue</p>	www.wago.com/2000-409/000-006
	<p>Item no.: 2000-410 Push-in type jumper bar; insulated; 10-way; Nominal current 14 A; light gray</p>	www.wago.com/2000-410
	<p>Item no.: 2000-410/000-005 Push-in type jumper bar; insulated; 10-way; Nominal current 14 A; red</p>	www.wago.com/2000-410/000-005
	<p>Item no.: 2000-410/000-006 Push-in type jumper bar; insulated; 10-way; Nominal current 14 A; blue</p>	www.wago.com/2000-410/000-006
	<p>Item no.: 2000-433 Push-in type jumper bar; insulated; from 1 to 3; Nominal current 14 A; light gray</p>	www.wago.com/2000-433
	<p>Item no.: 2000-433/000-005 Push-in type jumper bar; insulated; from 1 to 3; Nominal current 14 A; red</p>	www.wago.com/2000-433/000-005
	<p>Item no.: 2000-433/000-006 Push-in type jumper bar; insulated; from 1 to 3; Nominal current 14 A; blue</p>	www.wago.com/2000-433/000-006
	<p>Item no.: 2000-434 Push-in type jumper bar; insulated; from 1 to 4; Nominal current 14 A; light gray</p>	www.wago.com/2000-434
	<p>Item no.: 2000-435 Push-in type jumper bar; insulated; from 1 to 5; Nominal current 14 A; light gray</p>	www.wago.com/2000-435
	<p>Item no.: 2000-436 Push-in type jumper bar; insulated; from 1 to 6; Nominal current 14 A; light gray</p>	www.wago.com/2000-436
	<p>Item no.: 2000-437 Push-in type jumper bar; insulated; from 1 to 7; Nominal current 14 A; light gray</p>	www.wago.com/2000-437
	<p>Item no.: 2000-438 Push-in type jumper bar; insulated; from 1 to 8; Nominal current 14 A; light gray</p>	www.wago.com/2000-438
	<p>Item no.: 2000-439 Push-in type jumper bar; insulated; from 1 to 9; Nominal current 14 A; light gray</p>	www.wago.com/2000-439
	<p>Item no.: 2000-440 Push-in type jumper bar; insulated; from 1 to 10; Nominal current 14 A; light gray</p>	www.wago.com/2000-440
	<p>Item no.: 210-103 Wire commoning chain; insulated; 50 connections; black</p>	www.wago.com/210-103

Subject to changes. Please also observe the further product documentation!

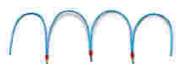

Item no.: 210-123
Wire commoning chain; insulated; 50 connections

www.wago.com/210-123

Protective Warning Marker

Item no.: 2000-115
Protective warning marker; with high-voltage symbol, black; for 5 terminal blocks; yellow

www.wago.com/2000-115

tools

Item no.: 210-647
Operating tool; Blade: 2.5 x 0.4 mm; with a partially insulated shaft

www.wago.com/210-647

Item no.: 210-648
Operating tool; Blade: 2.5 x 0.4 mm; with a partially insulated shaft; angled; short

www.wago.com/210-648



Item no.: 210-719
Operating tool; Blade: 2.5 x 0.4 mm; with a partially insulated shaft

www.wago.com/210-719

General accessories



Item no.: 2020-161
Start module for 1-conductor female connector; with integrated end plate; 1.5 mm²; 1-pole; 1,50 mm²; gray

www.wago.com/2020-161



Item no.: 2020-164
Start module for 1-conductor female connector; with integrated end plate; 1.5 mm²; 1-pole; 1,50 mm²; blue

www.wago.com/2020-164



Item no.: 2020-167
Start module for 1-conductor female connector; 1.5 mm²; 1-pole; 1,50 mm²; green-yellow

www.wago.com/2020-167



Item no.: 2020-181
End module for 1-conductor female connector; 1.5 mm²; 1-pole; 1,50 mm²; gray

www.wago.com/2020-181



Item no.: 2020-184
End module for 1-conductor female connector; 1.5 mm²; 1-pole; 1,50 mm²; blue

www.wago.com/2020-184



Item no.: 2020-187
End module for 1-conductor female connector; 1.5 mm²; 1-pole; 1,50 mm²; green-yellow

www.wago.com/2020-187



Item no.: 2020-261
Start module for 2-conductor female connector; with integrated end plate; 1.5 mm²; 1-pole; 1,50 mm²; gray

www.wago.com/2020-261



Item no.: 2020-264
Start module for 2-conductor female connector; with integrated end plate; 1.5 mm²; 1-pole; 1,50 mm²; blue

www.wago.com/2020-264



Item no.: 2020-267
Start module for 2-conductor female connector; 1.5 mm²; 1-pole; 1,50 mm²; green-yellow

www.wago.com/2020-267



Item no.: 2020-281
End module for 2-conductor female connector; 1.5 mm²; 1-pole; 1,50 mm²; gray

www.wago.com/2020-281



Item no.: 2020-284
End module for 2-conductor female connector; 1.5 mm²; 1-pole; 1,50 mm²; blue

www.wago.com/2020-284

Subject to changes. Please also observe the further product documentation!



Item no.: 2020-287

End module for 2-conductor female connector; 1.5 mm²; 1-pole; 1,50 mm²; green-yellowwww.wago.com/2020-287

Test Accessories



Item no.: 2009-174

Test plug adapter; for 4 mm Ø test plugs; for testing TOPJOB®S rail-mounted terminal blocks; gray

www.wago.com/2009-174

Item no.: 2009-182

Testing tap; for max. 2.5 mm²; tool-free connection for individual test wires 0.08 - 2.5 mm; graywww.wago.com/2009-182

Item no.: 859-500

Test pin; 1 mm Ø; with solder connection for test wire

www.wago.com/859-500

ferrule

Item no.: 216-241

Ferrule; Sleeve for 0.5 mm² / 20 AWG; insulated; electro-tin plated; electrolytic copper; gastight crimped; acc. to DIN 46228, Part 4/09.90; whitewww.wago.com/216-241

Item no.: 216-242

Ferrule; Sleeve for 0.75 mm² / 18 AWG; insulated; electro-tin plated; electrolytic copper; gastight crimped; acc. to DIN 46228, Part 4/09.90; graywww.wago.com/216-242

Item no.: 216-243

Ferrule; Sleeve for 1 mm² / AWG 18; insulated; electro-tin plated; electrolytic copper; gastight crimped; acc. to DIN 46228, Part 4/09.90; redwww.wago.com/216-243

Push-In type wire jumper



Item no.: 2009-402

Push-in type wire jumper; insulated; wire length 60 mm; Conductor cross section 0.75 mm²; suitable for 2000 and 2020 Series rail-mounted terminal blocks; graywww.wago.com/2009-402

Item no.: 2009-404

Push-in type wire jumper; insulated; wire length 110 mm; Conductor cross section 0.75 mm²; suitable for 2000 and 2020 Series rail-mounted terminal blocks; graywww.wago.com/2009-404

Item no.: 2009-406

Push-in type wire jumper; insulated; wire length 250 mm; Conductor cross section 0.75 mm²; suitable for 2000 and 2020 Series rail-mounted terminal blocks; graywww.wago.com/2009-406

End plate



Item no.: 2020-1491

End and intermediate plate; 1 mm thick; gray

www.wago.com/2020-1491

Item no.: 2020-1492

End and intermediate plate; 1 mm thick; orange

www.wago.com/2020-1492

Female plug



Item no.: 2020-102

1-conductor female plug; 1.5 mm²; 2-pole; 1,50 mm²; graywww.wago.com/2020-102

Item no.: 2020-102/122-000

1-conductor female plug; Locking lever; 1.5 mm²; 2-pole; 1,50 mm²; graywww.wago.com/2020-102/122-000

Subject to changes. Please also observe the further product documentation!

WAGO Kontakttechnik GmbH & Co. KG

Hansastr. 27









32423 Minden

Phone: +49571 887-0 | Fax: +49571 887-169











Email: info.de@wago.com | Web: www.wago.com

Do you have any questions about our products?

We are always happy to take your call at +49 (571) 887-44222.

	<p>Item no.: 2020-102/132-000 1-conductor female plug; Strain relief plate; 1.5 mm²; 2-pole; 1,50 mm²; gray</p>	<p>www.wago.com/2020-102/132-000</p>
	<p>Item no.: 2020-102/142-000 1-conductor female plug; Strain relief plate; 1.5 mm²; 2-pole; 1,50 mm²; gray</p>	<p>www.wago.com/2020-102/142-000</p>
	<p>Item no.: 2020-103 1-conductor female plug; 1.5 mm²; 3-pole; 1,50 mm²; gray</p>	<p>www.wago.com/2020-103</p>
	<p>Item no.: 2020-103/000-036 1-conductor female plug; 1.5 mm²; 3-pole; 1,50 mm²; gray, green-yellow</p>	<p>www.wago.com/2020-103/000-036</p>
	<p>Item no.: 2020-103/000-037 1-conductor female plug; 1.5 mm²; 3-pole; 1,50 mm²; green-yellow, gray</p>	<p>www.wago.com/2020-103/000-037</p>
	<p>Item no.: 2020-103/000-038 1-conductor female plug; 1.5 mm²; 3-pole; 1,50 mm²; gray, blue, green-yellow</p>	<p>www.wago.com/2020-103/000-038</p>
	<p>Item no.: 2020-103/000-039 1-conductor female plug; 1.5 mm²; 3-pole; 1,50 mm²; green-yellow, blue, gray</p>	<p>www.wago.com/2020-103/000-039</p>
	<p>Item no.: 2020-103/122-000 1-conductor female plug; Locking lever; 1.5 mm²; 3-pole; 1,50 mm²; gray</p>	<p>www.wago.com/2020-103/122-000</p>
	<p>Item no.: 2020-103/132-000 1-conductor female plug; Strain relief plate; 1.5 mm²; 3-pole; 1,50 mm²; gray</p>	<p>www.wago.com/2020-103/132-000</p>
	<p>Item no.: 2020-103/142-000 1-conductor female plug; Strain relief plate; 1.5 mm²; 3-pole; 1,50 mm²; gray</p>	<p>www.wago.com/2020-103/142-000</p>
	<p>Item no.: 2020-104 1-conductor female plug; 1.5 mm²; 4-pole; 1,50 mm²; gray</p>	<p>www.wago.com/2020-104</p>
	<p>Item no.: 2020-104/000-036 1-conductor female plug; 1.5 mm²; 4-pole; 1,50 mm²; gray, green-yellow</p>	<p>www.wago.com/2020-104/000-036</p>
	<p>Item no.: 2020-104/000-037 1-conductor female plug; 1.5 mm²; 4-pole; 1,50 mm²; green-yellow, gray</p>	<p>www.wago.com/2020-104/000-037</p>
	<p>Item no.: 2020-104/000-038 1-conductor female plug; 1.5 mm²; 4-pole; 1,50 mm²; gray, blue, green-yellow</p>	<p>www.wago.com/2020-104/000-038</p>

Subject to changes. Please also observe the further product documentation!

	<p>Item no.: 2020-104/000-039 1-conductor female plug; 1.5 mm²; 4-pole; 1,50 mm²; green-yellow, blue, gray</p>	www.wago.com/2020-104/000-039
	<p>Item no.: 2020-104/124-000 1-conductor female plug; Locking lever; 1.5 mm²; 4-pole; 1,50 mm²; gray</p>	www.wago.com/2020-104/124-000
	<p>Item no.: 2020-104/133-000 1-conductor female plug; Strain relief plate; 1.5 mm²; 4-pole; 1,50 mm²; gray</p>	www.wago.com/2020-104/133-000
	<p>Item no.: 2020-104/143-000 1-conductor female plug; Strain relief plate; 1.5 mm²; 4-pole; 1,50 mm²; gray</p>	www.wago.com/2020-104/143-000
	<p>Item no.: 2020-105 1-conductor female plug; 1.5 mm²; 5-pole; 1,50 mm²; gray</p>	www.wago.com/2020-105
	<p>Item no.: 2020-105/000-036 1-conductor female plug; 1.5 mm²; 5-pole; 1,50 mm²; gray, green-yellow</p>	www.wago.com/2020-105/000-036
	<p>Item no.: 2020-105/000-037 1-conductor female plug; 1.5 mm²; 5-pole; 1,50 mm²; green-yellow, gray</p>	www.wago.com/2020-105/000-037
	<p>Item no.: 2020-105/000-038 1-conductor female plug; 1.5 mm²; 5-pole; 1,50 mm²; gray, blue, green-yellow</p>	www.wago.com/2020-105/000-038
	<p>Item no.: 2020-105/000-039 1-conductor female plug; 1.5 mm²; 5-pole; 1,50 mm²; green-yellow, blue, gray</p>	www.wago.com/2020-105/000-039
	<p>Item no.: 2020-105/124-000 1-conductor female plug; Locking lever; 1.5 mm²; 5-pole; 1,50 mm²; gray</p>	www.wago.com/2020-105/124-000
	<p>Item no.: 2020-105/133-000 1-conductor female plug; Strain relief plate; 1.5 mm²; 5-pole; 1,50 mm²; gray</p>	www.wago.com/2020-105/133-000
	<p>Item no.: 2020-105/143-000 1-conductor female plug; Strain relief plate; 1.5 mm²; 5-pole; 1,50 mm²; gray</p>	www.wago.com/2020-105/143-000
	<p>Item no.: 2020-106 1-conductor female plug; 1.5 mm²; 6-pole; 1,50 mm²; gray</p>	www.wago.com/2020-106
	<p>Item no.: 2020-106/000-036 1-conductor female plug; 1.5 mm²; 6-pole; 1,50 mm²; gray, green-yellow</p>	www.wago.com/2020-106/000-036

Subject to changes. Please also observe the further product documentation!



Item no.: 2020-106/000-037
1-conductor female plug; 1.5 mm²; 6-pole; 1,50 mm²; green-yellow, gray

www.wago.com/2020-106/000-037



Item no.: 2020-106/000-038
1-conductor female plug; 1.5 mm²; 6-pole; 1,50 mm²; gray, blue, green-yellow

www.wago.com/2020-106/000-038



Item no.: 2020-106/000-039
1-conductor female plug; 1.5 mm²; 6-pole; 1,50 mm²; green-yellow, blue, gray

www.wago.com/2020-106/000-039

Item no.: 2020-106/124-000
1-conductor female plug; Locking lever; 1.5 mm²; 6-pole; 1,50 mm²; gray

www.wago.com/2020-106/124-000

Item no.: 2020-106/133-000
1-conductor female plug; Strain relief plate; 1.5 mm²; 6-pole; 1,50 mm²; gray

www.wago.com/2020-106/133-000

Item no.: 2020-106/143-000
1-conductor female plug; Strain relief plate; 1.5 mm²; 6-pole; 1,50 mm²; gray

www.wago.com/2020-106/143-000



Item no.: 2020-107
1-conductor female plug; 1.5 mm²; 7-pole; 1,50 mm²; gray

www.wago.com/2020-107



Item no.: 2020-107/000-036
1-conductor female plug; 1.5 mm²; 7-pole; 1,50 mm²; gray, green-yellow

www.wago.com/2020-107/000-036



Item no.: 2020-107/000-037
1-conductor female plug; 1.5 mm²; 7-pole; 1,50 mm²; green-yellow, gray

www.wago.com/2020-107/000-037



Item no.: 2020-107/000-038
1-conductor female plug; 1.5 mm²; 7-pole; 1,50 mm²; gray, blue, green-yellow

www.wago.com/2020-107/000-038



Item no.: 2020-107/000-039
1-conductor female plug; 1.5 mm²; 7-pole; 1,50 mm²; green-yellow, blue, gray

www.wago.com/2020-107/000-039

Item no.: 2020-107/124-000
1-conductor female plug; Locking lever; 1.5 mm²; 7-pole; 1,50 mm²; gray

www.wago.com/2020-107/124-000











Item no.: 2020-107/134-000
1-conductor female plug; Strain relief plate; 1.5 mm²; 7-pole; 1,50 mm²; gray

www.wago.com/2020-107/134-000









Item no.: 2020-107/144-000
1-conductor female plug; Strain relief plate; 1.5 mm²; 7-pole; 1,50 mm²; gray

www.wago.com/2020-107/144-000









Subject to changes. Please also observe the further product documentation!

	Item no.: 2020-108 1-conductor female plug; 1.5 mm ² ; 8-pole; 1,50 mm ² ; gray	www.wago.com/2020-108
	Item no.: 2020-108/000-036 1-conductor female plug; 1.5 mm ² ; 8-pole; 1,50 mm ² ; gray, green-yellow	www.wago.com/2020-108/000-036
	Item no.: 2020-108/000-037 1-conductor female plug; 1.5 mm ² ; 8-pole; 1,50 mm ² ; green-yellow, gray	www.wago.com/2020-108/000-037
	Item no.: 2020-108/000-038 1-conductor female plug; 1.5 mm ² ; 8-pole; 1,50 mm ² ; gray, blue, green-yellow	www.wago.com/2020-108/000-038
	Item no.: 2020-108/000-039 1-conductor female plug; 1.5 mm ² ; 8-pole; 1,50 mm ² ; green-yellow, blue, gray	www.wago.com/2020-108/000-039
	Item no.: 2020-108/124-000 1-conductor female plug; Locking lever; 1.5 mm ² ; 8-pole; 1,50 mm ² ; gray	www.wago.com/2020-108/124-000
	Item no.: 2020-108/134-000 1-conductor female plug; Strain relief plate; 1.5 mm ² ; 8-pole; 1,50 mm ² ; gray	www.wago.com/2020-108/134-000
	Item no.: 2020-108/144-000 1-conductor female plug; Strain relief plate; 1.5 mm ² ; 8-pole; 1,50 mm ² ; gray	www.wago.com/2020-108/144-000
	Item no.: 2020-109 1-conductor female plug; 1.5 mm ² ; 9-pole; 1,50 mm ² ; gray	www.wago.com/2020-109
	Item no.: 2020-109/000-036 1-conductor female plug; 1.5 mm ² ; 9-pole; 1,50 mm ² ; gray, green-yellow	www.wago.com/2020-109/000-036
	Item no.: 2020-109/000-037 1-conductor female plug; 1.5 mm ² ; 9-pole; 1,50 mm ² ; green-yellow, gray	www.wago.com/2020-109/000-037
	Item no.: 2020-109/000-038 1-conductor female plug; 1.5 mm ² ; 9-pole; 1,50 mm ² ; gray, blue, green-yellow	www.wago.com/2020-109/000-038
	Item no.: 2020-109/000-039 1-conductor female plug; 1.5 mm ² ; 9-pole; 1,50 mm ² ; green-yellow, blue, gray	www.wago.com/2020-109/000-039
	Item no.: 2020-109/124-000 1-conductor female plug; Locking lever; 1.5 mm ² ; 9-pole; 1,50 mm ² ; gray	www.wago.com/2020-109/124-000









Subject to changes. Please also observe the further product documentation!

	Item no.: 2020-109/134-000 1-conductor female plug; Strain relief plate; 1.5 mm ² ; 9-pole; 1,50 mm ² ; gray	www.wago.com/2020-109/134-000
	Item no.: 2020-109/144-000 1-conductor female plug; Strain relief plate; 1.5 mm ² ; 9-pole; 1,50 mm ² ; gray	www.wago.com/2020-109/144-000
	Item no.: 2020-110 1-conductor female plug; 1.5 mm ² ; 10-pole; 1,50 mm ² ; gray	www.wago.com/2020-110
	Item no.: 2020-110/000-036 1-conductor female plug; 1.5 mm ² ; 10-pole; 1,50 mm ² ; gray, green-yellow	www.wago.com/2020-110/000-036
	Item no.: 2020-110/000-037 1-conductor female plug; 1.5 mm ² ; 10-pole; 1,50 mm ² ; green-yellow, gray	www.wago.com/2020-110/000-037
	Item no.: 2020-110/000-038 1-conductor female plug; 1.5 mm ² ; 10-pole; 1,50 mm ² ; gray, blue, green-yellow	www.wago.com/2020-110/000-038
	Item no.: 2020-110/000-039 1-conductor female plug; 1.5 mm ² ; 10-pole; 1,50 mm ² ; green-yellow, blue, gray	www.wago.com/2020-110/000-039
	Item no.: 2020-110/125-000 1-conductor female plug; Locking lever; 1.5 mm ² ; 10-pole; 1,50 mm ² ; gray	www.wago.com/2020-110/125-000
	Item no.: 2020-110/135-000 1-conductor female plug; Strain relief plate; 1.5 mm ² ; 10-pole; 1,50 mm ² ; gray	www.wago.com/2020-110/135-000
	Item no.: 2020-110/145-000 1-conductor female plug; Strain relief plate; 1.5 mm ² ; 10-pole; 1,50 mm ² ; gray	www.wago.com/2020-110/145-000
	Item no.: 2020-111 1-conductor female plug; 1.5 mm ² ; 11-pole; 1,50 mm ² ; gray	www.wago.com/2020-111
	Item no.: 2020-111/000-036 1-conductor female plug; 1.5 mm ² ; 11-pole; 1,50 mm ² ; gray, green-yellow	www.wago.com/2020-111/000-036
	Item no.: 2020-111/000-037 1-conductor female plug; 1.5 mm ² ; 11-pole; 1,50 mm ² ; green-yellow, gray	www.wago.com/2020-111/000-037
	Item no.: 2020-111/000-038 1-conductor female plug; 1.5 mm ² ; 11-pole; 1,50 mm ² ; gray, blue, green-yellow	www.wago.com/2020-111/000-038







Subject to changes. Please also observe the further product documentation!

	Item no.: 2020-111/000-039 1-conductor female plug; 1.5 mm ² ; 11-pole; 1,50 mm ² ; green-yellow, blue, gray	www.wago.com/2020-111/000-039
	Item no.: 2020-111/125-000 1-conductor female plug; Locking lever; 1.5 mm ² ; 11-pole; 1,50 mm ² ; gray	www.wago.com/2020-111/125-000
	Item no.: 2020-111/135-000 1-conductor female plug; Strain relief plate; 1.5 mm ² ; 11-pole; 1,50 mm ² ; gray	www.wago.com/2020-111/135-000
	Item no.: 2020-111/145-000 1-conductor female plug; Strain relief plate; 1.5 mm ² ; 11-pole; 1,50 mm ² ; gray	www.wago.com/2020-111/145-000
	Item no.: 2020-112 1-conductor female plug; 1.5 mm ² ; 12-pole; 1,50 mm ² ; gray	www.wago.com/2020-112
	Item no.: 2020-112/000-036 1-conductor female plug; 1.5 mm ² ; 12-pole; 1,50 mm ² ; gray, green-yellow	www.wago.com/2020-112/000-036
	Item no.: 2020-112/000-037 1-conductor female plug; 1.5 mm ² ; 12-pole; 1,50 mm ² ; green-yellow, gray	www.wago.com/2020-112/000-037
	Item no.: 2020-112/000-038 1-conductor female plug; 1.5 mm ² ; 12-pole; 1,50 mm ² ; gray, blue, green-yellow	www.wago.com/2020-112/000-038
	Item no.: 2020-112/000-039 1-conductor female plug; 1.5 mm ² ; 12-pole; 1,50 mm ² ; green-yellow, blue, gray	www.wago.com/2020-112/000-039
	Item no.: 2020-112/125-000 1-conductor female plug; Locking lever; 1.5 mm ² ; 12-pole; 1,50 mm ² ; gray	www.wago.com/2020-112/125-000
	Item no.: 2020-112/135-000 1-conductor female plug; Strain relief plate; 1.5 mm ² ; 12-pole; 1,50 mm ² ; gray	www.wago.com/2020-112/135-000
	Item no.: 2020-112/145-000 1-conductor female plug; Strain relief plate; 1.5 mm ² ; 12-pole; 1,50 mm ² ; gray	www.wago.com/2020-112/145-000
	Item no.: 2020-113 1-conductor female plug; 1.5 mm ² ; 13-pole; 1,50 mm ² ; gray	www.wago.com/2020-113
	Item no.: 2020-113/000-036 1-conductor female plug; 1.5 mm ² ; 13-pole; 1,50 mm ² ; gray, green-yellow	www.wago.com/2020-113/000-036









Subject to changes. Please also observe the further product documentation!

	<p>Item no.: 2020-113/000-037 1-conductor female plug; 1.5 mm²; 13-pole; 1,50 mm²; green-yellow, gray</p>	www.wago.com/2020-113/000-037
	<p>Item no.: 2020-113/000-038 1-conductor female plug; 1.5 mm²; 13-pole; 1,50 mm²; gray, blue, green-yellow</p>	www.wago.com/2020-113/000-038
	<p>Item no.: 2020-113/000-039 1-conductor female plug; 1.5 mm²; 13-pole; 1,50 mm²; green-yellow, blue, gray</p>	www.wago.com/2020-113/000-039
	<p>Item no.: 2020-113/125-000 1-conductor female plug; Locking lever; 1.5 mm²; 13-pole; 1,50 mm²; gray</p>	www.wago.com/2020-113/125-000
	<p>Item no.: 2020-113/135-000 1-conductor female plug; Strain relief plate; 1.5 mm²; 13-pole; 1,50 mm²; gray</p>	www.wago.com/2020-113/135-000
	<p>Item no.: 2020-113/145-000 1-conductor female plug; Strain relief plate; 1.5 mm²; 13-pole; 1,50 mm²; gray</p>	www.wago.com/2020-113/145-000
	<p>Item no.: 2020-114 1-conductor female plug; 1.5 mm²; 14-pole; 1,50 mm²; gray</p>	www.wago.com/2020-114
	<p>Item no.: 2020-114/000-036 1-conductor female plug; 1.5 mm²; 14-pole; 1,50 mm²; gray, green-yellow</p>	www.wago.com/2020-114/000-036
	<p>Item no.: 2020-114/000-037 1-conductor female plug; 1.5 mm²; 14-pole; 1,50 mm²; green-yellow, gray</p>	www.wago.com/2020-114/000-037
	<p>Item no.: 2020-114/000-038 1-conductor female plug; 1.5 mm²; 14-pole; 1,50 mm²; gray, blue, green-yellow</p>	www.wago.com/2020-114/000-038
	<p>Item no.: 2020-114/000-039 1-conductor female plug; 1.5 mm²; 14-pole; 1,50 mm²; green-yellow, blue, gray</p>	www.wago.com/2020-114/000-039
	<p>Item no.: 2020-114/125-000 1-conductor female plug; Locking lever; 1.5 mm²; 14-pole; 1,50 mm²; gray</p>	www.wago.com/2020-114/125-000
	<p>Item no.: 2020-114/135-000 1-conductor female plug; Strain relief plate; 1.5 mm²; 14-pole; 1,50 mm²; gray</p>	www.wago.com/2020-114/135-000













Subject to changes. Please also observe the further product documentation!

	Item no.: 2020-114/145-000 1-conductor female plug; Strain relief plate; 1.5 mm ² ; 14-pole; 1,50 mm ² ; gray	www.wago.com/2020-114/145-000
	Item no.: 2020-115 1-conductor female plug; 1.5 mm ² ; 15-pole; 1,50 mm ² ; gray	www.wago.com/2020-115
	Item no.: 2020-115/000-036 1-conductor female plug; 1.5 mm ² ; 15-pole; 1,50 mm ² ; gray, green-yellow	www.wago.com/2020-115/000-036
	Item no.: 2020-115/000-037 1-conductor female plug; 1.5 mm ² ; 15-pole; 1,50 mm ² ; green-yellow, gray	www.wago.com/2020-115/000-037
	Item no.: 2020-115/000-038 1-conductor female plug; 1.5 mm ² ; 15-pole; 1,50 mm ² ; gray, blue, green-yellow	www.wago.com/2020-115/000-038
	Item no.: 2020-115/000-039 1-conductor female plug; 1.5 mm ² ; 15-pole; 1,50 mm ² ; green-yellow, blue, gray	www.wago.com/2020-115/000-039
	Item no.: 2020-115/125-000 1-conductor female plug; Locking lever; 1.5 mm ² ; 15-pole; 1,50 mm ² ; gray	www.wago.com/2020-115/125-000
	Item no.: 2020-115/135-000 1-conductor female plug; Strain relief plate; 1.5 mm ² ; 15-pole; 1,50 mm ² ; gray	www.wago.com/2020-115/135-000
	Item no.: 2020-115/145-000 1-conductor female plug; Strain relief plate; 1.5 mm ² ; 15-pole; 1,50 mm ² ; gray	www.wago.com/2020-115/145-000
	Item no.: 2020-202 2-conductor female connector; 1.5 mm ² ; 2-pole; 1,50 mm ² ; gray	www.wago.com/2020-202
	Item no.: 2020-202/122-000 2-conductor female connector; Locking lever; 1.5 mm ² ; 2-pole; 1,50 mm ² ; gray	www.wago.com/2020-202/122-000
	Item no.: 2020-202/132-000 2-conductor female connector; Strain relief plate; 1.5 mm ² ; 2-pole; 1,50 mm ² ; gray	www.wago.com/2020-202/132-000
	Item no.: 2020-202/142-000 2-conductor female connector; Strain relief plate; 1.5 mm ² ; 2-pole; 1,50 mm ² ; gray	www.wago.com/2020-202/142-000
	Item no.: 2020-203 2-conductor female connector; 1.5 mm ² ; 3-pole; 1,50 mm ² ; gray	www.wago.com/2020-203









Subject to changes. Please also observe the further product documentation!

	<p>Item no.: 2020-203/000-036 2-conductor female connector; 1.5 mm²; 3-pole; 1,50 mm²; gray, green-yellow</p>	www.wago.com/2020-203/000-036
	<p>Item no.: 2020-203/000-037 2-conductor female connector; 1.5 mm²; 3-pole; 1,50 mm²; green-yellow, gray</p>	www.wago.com/2020-203/000-037
	<p>Item no.: 2020-203/000-038 2-conductor female connector; 1.5 mm²; 3-pole; 1,50 mm²; gray, blue, green-yellow</p>	www.wago.com/2020-203/000-038
	<p>Item no.: 2020-203/000-039 2-conductor female connector; 1.5 mm²; 3-pole; 1,50 mm²; green-yellow, blue, gray</p>	www.wago.com/2020-203/000-039
	<p>Item no.: 2020-203/122-000 2-conductor female connector; Locking lever; 1.5 mm²; 3-pole; 1,50 mm²; gray</p>	www.wago.com/2020-203/122-000
	<p>Item no.: 2020-203/132-000 2-conductor female connector; Strain relief plate; 1.5 mm²; 3-pole; 1,50 mm²; gray</p>	www.wago.com/2020-203/132-000
	<p>Item no.: 2020-203/142-000 2-conductor female connector; Strain relief plate; 1.5 mm²; 3-pole; 1,50 mm²; gray</p>	www.wago.com/2020-203/142-000
	<p>Item no.: 2020-204 2-conductor female connector; 1.5 mm²; 4-pole; 1,50 mm²; gray</p>	www.wago.com/2020-204
	<p>Item no.: 2020-204/000-036 2-conductor female connector; 1.5 mm²; 4-pole; 1,50 mm²; gray, green-yellow</p>	www.wago.com/2020-204/000-036
	<p>Item no.: 2020-204/000-037 2-conductor female connector; 1.5 mm²; 4-pole; 1,50 mm²; green-yellow, gray</p>	www.wago.com/2020-204/000-037
	<p>Item no.: 2020-204/000-038 2-conductor female connector; 1.5 mm²; 4-pole; 1,50 mm²; gray, blue, green-yellow</p>	www.wago.com/2020-204/000-038
	<p>Item no.: 2020-204/000-039 2-conductor female connector; 1.5 mm²; 4-pole; 1,50 mm²; green-yellow, blue, gray</p>	www.wago.com/2020-204/000-039
	<p>Item no.: 2020-204/124-000 2-conductor female connector; Locking lever; 1.5 mm²; 4-pole; 1,50 mm²; gray</p>	www.wago.com/2020-204/124-000
	<p>Item no.: 2020-204/133-000 2-conductor female connector; Strain relief plate; 1.5 mm²; 4-pole; 1,50 mm²; gray</p>	www.wago.com/2020-204/133-000









Subject to changes. Please also observe the further product documentation!

	Item no.: 2020-204/143-000 2-conductor female connector; Strain relief plate; 1.5 mm ² ; 4-pole; 1,50 mm ² ; gray	www.wago.com/2020-204/143-000
	Item no.: 2020-205 2-conductor female connector; 1.5 mm ² ; 5-pole; 1,50 mm ² ; gray	www.wago.com/2020-205
	Item no.: 2020-205/000-036 2-conductor female connector; 1.5 mm ² ; 5-pole; 1,50 mm ² ; gray, green-yellow	www.wago.com/2020-205/000-036
	Item no.: 2020-205/000-037 2-conductor female connector; 1.5 mm ² ; 5-pole; 1,50 mm ² ; green-yellow, gray	www.wago.com/2020-205/000-037
	Item no.: 2020-205/000-038 2-conductor female connector; 1.5 mm ² ; 5-pole; 1,50 mm ² ; gray, blue, green-yellow	www.wago.com/2020-205/000-038
	Item no.: 2020-205/000-039 2-conductor female connector; 1.5 mm ² ; 5-pole; 1,50 mm ² ; green-yellow, blue, gray	www.wago.com/2020-205/000-039
	Item no.: 2020-205/124-000 2-conductor female connector; Locking lever; 1.5 mm ² ; 5-pole; 1,50 mm ² ; gray	www.wago.com/2020-205/124-000
	Item no.: 2020-205/133-000 2-conductor female connector; Strain relief plate; 1.5 mm ² ; 5-pole; 1,50 mm ² ; gray	www.wago.com/2020-205/133-000
	Item no.: 2020-205/143-000 2-conductor female connector; Strain relief plate; 1.5 mm ² ; 5-pole; 1,50 mm ² ; gray	www.wago.com/2020-205/143-000
	Item no.: 2020-206 2-conductor female connector; 1.5 mm ² ; 6-pole; 1,50 mm ² ; gray	www.wago.com/2020-206
	Item no.: 2020-206/000-036 2-conductor female connector; 1.5 mm ² ; 6-pole; 1,50 mm ² ; gray, green-yellow	www.wago.com/2020-206/000-036
	Item no.: 2020-206/000-037 2-conductor female connector; 1.5 mm ² ; 6-pole; 1,50 mm ² ; green-yellow, gray	www.wago.com/2020-206/000-037
	Item no.: 2020-206/000-038 2-conductor female connector; 1.5 mm ² ; 6-pole; 1,50 mm ² ; gray, blue, green-yellow	www.wago.com/2020-206/000-038
	Item no.: 2020-206/000-039 2-conductor female connector; 1.5 mm ² ; 6-pole; 1,50 mm ² ; green-yellow, blue, gray	www.wago.com/2020-206/000-039









Subject to changes. Please also observe the further product documentation!

	Item no.: 2020-206/124-000 2-conductor female connector; Locking lever; 1.5 mm ² ; 6-pole; 1,50 mm ² ; gray	www.wago.com/2020-206/124-000
	Item no.: 2020-206/133-000 2-conductor female connector; Strain relief plate; 1.5 mm ² ; 6-pole; 1,50 mm ² ; gray	www.wago.com/2020-206/133-000
	Item no.: 2020-206/143-000 2-conductor female connector; Strain relief plate; 1.5 mm ² ; 6-pole; 1,50 mm ² ; gray	www.wago.com/2020-206/143-000
	Item no.: 2020-207 2-conductor female connector; 1.5 mm ² ; 7-pole; 1,50 mm ² ; gray	www.wago.com/2020-207
	Item no.: 2020-207/000-036 2-conductor female connector; 1.5 mm ² ; 7-pole; 1,50 mm ² ; gray, green-yellow	www.wago.com/2020-207/000-036
	Item no.: 2020-207/000-037 2-conductor female connector; 1.5 mm ² ; 7-pole; 1,50 mm ² ; green-yellow, gray	www.wago.com/2020-207/000-037
	Item no.: 2020-207/000-038 2-conductor female connector; 1.5 mm ² ; 7-pole; 1,50 mm ² ; gray, blue, green-yellow	www.wago.com/2020-207/000-038
	Item no.: 2020-207/000-039 2-conductor female connector; 1.5 mm ² ; 7-pole; 1,50 mm ² ; green-yellow, blue, gray	www.wago.com/2020-207/000-039
	Item no.: 2020-207/124-000 2-conductor female connector; Locking lever; 1.5 mm ² ; 7-pole; 1,50 mm ² ; gray	www.wago.com/2020-207/124-000
	Item no.: 2020-207/134-000 2-conductor female connector; Strain relief plate; 1.5 mm ² ; 7-pole; 1,50 mm ² ; gray	www.wago.com/2020-207/134-000
	Item no.: 2020-207/144-000 2-conductor female connector; Strain relief plate; 1.5 mm ² ; 7-pole; 1,50 mm ² ; gray	www.wago.com/2020-207/144-000
	Item no.: 2020-208 2-conductor female connector; 1.5 mm ² ; 8-pole; 1,50 mm ² ; gray	www.wago.com/2020-208
	Item no.: 2020-208/000-036 2-conductor female connector; 1.5 mm ² ; 8-pole; 1,50 mm ² ; gray, green-yellow	www.wago.com/2020-208/000-036
	Item no.: 2020-208/000-037 2-conductor female connector; 1.5 mm ² ; 8-pole; 1,50 mm ² ; green-yellow, gray	www.wago.com/2020-208/000-037









Subject to changes. Please also observe the further product documentation!

	Item no.: 2020-208/000-038 2-conductor female connector; 1.5 mm ² ; 8-pole; 1,50 mm ² ; gray, blue, green-yellow	www.wago.com/2020-208/000-038
	Item no.: 2020-208/000-039 2-conductor female connector; 1.5 mm ² ; 8-pole; 1,50 mm ² ; green-yellow, blue, gray	www.wago.com/2020-208/000-039
	Item no.: 2020-208/124-000 2-conductor female connector; Locking lever; 1.5 mm ² ; 8-pole; 1,50 mm ² ; gray	www.wago.com/2020-208/124-000
	Item no.: 2020-208/134-000 2-conductor female connector; Strain relief plate; 1.5 mm ² ; 8-pole; 1,50 mm ² ; gray	www.wago.com/2020-208/134-000
	Item no.: 2020-208/144-000 2-conductor female connector; Strain relief plate; 1.5 mm ² ; 8-pole; 1,50 mm ² ; gray	www.wago.com/2020-208/144-000
	Item no.: 2020-209 2-conductor female connector; 1.5 mm ² ; 9-pole; 1,50 mm ² ; gray	www.wago.com/2020-209
	Item no.: 2020-209/000-036 2-conductor female connector; 1.5 mm ² ; 9-pole; 1,50 mm ² ; gray, green-yellow	www.wago.com/2020-209/000-036
	Item no.: 2020-209/000-037 2-conductor female connector; 1.5 mm ² ; 9-pole; 1,50 mm ² ; green-yellow, gray	www.wago.com/2020-209/000-037
	Item no.: 2020-209/000-038 2-conductor female connector; 1.5 mm ² ; 9-pole; 1,50 mm ² ; gray, blue, green-yellow	www.wago.com/2020-209/000-038
	Item no.: 2020-209/000-039 2-conductor female connector; 1.5 mm ² ; 9-pole; 1,50 mm ² ; green-yellow, blue, gray	www.wago.com/2020-209/000-039
	Item no.: 2020-209/124-000 2-conductor female connector; Locking lever; 1.5 mm ² ; 9-pole; 1,50 mm ² ; gray	www.wago.com/2020-209/124-000
	Item no.: 2020-209/134-000 2-conductor female connector; Strain relief plate; 1.5 mm ² ; 9-pole; 1,50 mm ² ; gray	www.wago.com/2020-209/134-000
	Item no.: 2020-209/144-000 2-conductor female connector; Strain relief plate; 1.5 mm ² ; 9-pole; 1,50 mm ² ; gray	www.wago.com/2020-209/144-000
	Item no.: 2020-210 2-conductor female connector; 1.5 mm ² ; 10-pole; 1,50 mm ² ; gray	www.wago.com/2020-210

Subject to changes. Please also observe the further product documentation!

	<p>Item no.: 2020-210/000-036 2-conductor female connector; 1.5 mm²; 10-pole; 1,50 mm²; gray, green-yellow</p>	www.wago.com/2020-210/000-036
	<p>Item no.: 2020-210/000-037 2-conductor female connector; 1.5 mm²; 10-pole; 1,50 mm²; green-yellow, gray</p>	www.wago.com/2020-210/000-037
	<p>Item no.: 2020-210/000-038 2-conductor female connector; 1.5 mm²; 10-pole; 1,50 mm²; gray, blue, green-yellow</p>	www.wago.com/2020-210/000-038
	<p>Item no.: 2020-210/000-039 2-conductor female connector; 1.5 mm²; 10-pole; 1,50 mm²; green-yellow, blue, gray</p>	www.wago.com/2020-210/000-039
	<p>Item no.: 2020-210/125-000 2-conductor female connector; Locking lever; 1.5 mm²; 10-pole; 1,50 mm²; gray</p>	www.wago.com/2020-210/125-000
	<p>Item no.: 2020-210/135-000 2-conductor female connector; Strain relief plate; 1.5 mm²; 10-pole; 1,50 mm²; gray</p>	www.wago.com/2020-210/135-000
	<p>Item no.: 2020-210/145-000 2-conductor female connector; Strain relief plate; 1.5 mm²; 10-pole; 1,50 mm²; gray</p>	www.wago.com/2020-210/145-000
	<p>Item no.: 2020-211 2-conductor female connector; 1.5 mm²; 11-pole; 1,50 mm²; gray</p>	www.wago.com/2020-211
	<p>Item no.: 2020-211/000-036 2-conductor female connector; 1.5 mm²; 11-pole; 1,50 mm²; gray, green-yellow</p>	www.wago.com/2020-211/000-036
	<p>Item no.: 2020-211/000-037 2-conductor female connector; 1.5 mm²; 11-pole; 1,50 mm²; green-yellow, gray</p>	www.wago.com/2020-211/000-037
	<p>Item no.: 2020-211/000-038 2-conductor female connector; 1.5 mm²; 11-pole; 1,50 mm²; gray, blue, green-yellow</p>	www.wago.com/2020-211/000-038
	<p>Item no.: 2020-211/000-039 2-conductor female connector; 1.5 mm²; 11-pole; 1,50 mm²; green-yellow, blue, gray</p>	www.wago.com/2020-211/000-039
	<p>Item no.: 2020-211/125-000 2-conductor female connector; Locking lever; 1.5 mm²; 11-pole; 1,50 mm²; gray</p>	www.wago.com/2020-211/125-000

Subject to changes. Please also observe the further product documentation!

	<p>Item no.: 2020-211/135-000 2-conductor female connector; Strain relief plate; 1.5 mm²; 11-pole; 1,50 mm²; gray</p>	<p>www.wago.com/2020-211/135-000</p>
	<p>Item no.: 2020-211/145-000 2-conductor female connector; Strain relief plate; 1.5 mm²; 11-pole; 1,50 mm²; gray</p>	<p>www.wago.com/2020-211/145-000</p>
	<p>Item no.: 2020-212 2-conductor female connector; 1.5 mm²; 12-pole; 1,50 mm²; gray</p>	<p>www.wago.com/2020-212</p>
	<p>Item no.: 2020-212/000-036 2-conductor female connector; 1.5 mm²; 12-pole; 1,50 mm²; gray, green-yellow</p>	<p>www.wago.com/2020-212/000-036</p>
	<p>Item no.: 2020-212/000-037 2-conductor female connector; 1.5 mm²; 12-pole; 1,50 mm²; green-yellow, gray</p>	<p>www.wago.com/2020-212/000-037</p>
	<p>Item no.: 2020-212/000-038 2-conductor female connector; 1.5 mm²; 12-pole; 1,50 mm²; gray, blue, green-yellow</p>	<p>www.wago.com/2020-212/000-038</p>
	<p>Item no.: 2020-212/000-039 2-conductor female connector; 1.5 mm²; 12-pole; 1,50 mm²; green-yellow, blue, gray</p>	<p>www.wago.com/2020-212/000-039</p>
	<p>Item no.: 2020-212/125-000 2-conductor female connector; Locking lever; 1.5 mm²; 12-pole; 1,50 mm²; gray</p>	<p>www.wago.com/2020-212/125-000</p>
	<p>Item no.: 2020-212/135-000 2-conductor female connector; Strain relief plate; 1.5 mm²; 12-pole; 1,50 mm²; gray</p>	<p>www.wago.com/2020-212/135-000</p>
	<p>Item no.: 2020-212/145-000 2-conductor female connector; Strain relief plate; 1.5 mm²; 12-pole; 1,50 mm²; gray</p>	<p>www.wago.com/2020-212/145-000</p>
	<p>Item no.: 2020-213 2-conductor female connector; 1.5 mm²; 13-pole; 1,50 mm²; gray</p>	<p>www.wago.com/2020-213</p>
	<p>Item no.: 2020-213/000-036 2-conductor female connector; 1.5 mm²; 13-pole; 1,50 mm²; gray, green-yellow</p>	<p>www.wago.com/2020-213/000-036</p>
	<p>Item no.: 2020-213/000-037 2-conductor female connector; 1.5 mm²; 13-pole; 1,50 mm²; green-yellow, gray</p>	<p>www.wago.com/2020-213/000-037</p>
	<p>Item no.: 2020-213/000-038 2-conductor female connector; 1.5 mm²; 13-pole; 1,50 mm²; gray, blue, green-yellow</p>	<p>www.wago.com/2020-213/000-038</p>

Subject to changes. Please also observe the further product documentation!



Item no.: 2020-213/000-039

2-conductor female connector; 1.5 mm²; 13-pole; 1,50 mm²; green-yellow, blue, gray

www.wago.com/2020-213/000-039

Item no.: 2020-213/125-000

2-conductor female connector; Locking lever; 1.5 mm²; 13-pole; 1,50 mm²; gray

www.wago.com/2020-213/125-000

Item no.: 2020-213/135-000

2-conductor female connector; Strain relief plate; 1.5 mm²; 13-pole; 1,50 mm²; gray

www.wago.com/2020-213/135-000

Item no.: 2020-213/145-000

2-conductor female connector; Strain relief plate; 1.5 mm²; 13-pole; 1,50 mm²; gray

www.wago.com/2020-213/145-000



Item no.: 2020-214

2-conductor female connector; 1.5 mm²; 14-pole; 1,50 mm²; gray

www.wago.com/2020-214



Item no.: 2020-214/000-036

2-conductor female connector; 1.5 mm²; 14-pole; 1,50 mm²; gray, green-yellow

www.wago.com/2020-214/000-036



Item no.: 2020-214/000-037

2-conductor female connector; 1.5 mm²; 14-pole; 1,50 mm²; green-yellow, gray

www.wago.com/2020-214/000-037



Item no.: 2020-214/000-038

2-conductor female connector; 1.5 mm²; 14-pole; 1,50 mm²; gray, blue, green-yellow

www.wago.com/2020-214/000-038



Item no.: 2020-214/000-039

2-conductor female connector; 1.5 mm²; 14-pole; 1,50 mm²; green-yellow, blue, gray

www.wago.com/2020-214/000-039

Item no.: 2020-214/125-000

2-conductor female connector; Locking lever; 1.5 mm²; 14-pole; 1,50 mm²; gray

www.wago.com/2020-214/125-000

Item no.: 2020-214/135-000

2-conductor female connector; Strain relief plate; 1.5 mm²; 14-pole; 1,50 mm²; gray

www.wago.com/2020-214/135-000

Item no.: 2020-214/145-000

2-conductor female connector; Strain relief plate; 1.5 mm²; 14-pole; 1,50 mm²; gray

www.wago.com/2020-214/145-000



Item no.: 2020-215

2-conductor female connector; 1.5 mm²; 15-pole; 1,50 mm²; gray

www.wago.com/2020-215



Item no.: 2020-215/000-036

2-conductor female connector; 1.5 mm²; 15-pole; 1,50 mm²; gray, green-yellow

www.wago.com/2020-215/000-036

Subject to changes. Please also observe the further product documentation!

WAGO Kontakttechnik GmbH & Co. KG

Hansastr. 27

32423 Minden

Phone: +49571 887-0 | Fax: +49571 887-169

Email: info.de@wago.com | Web: www.wago.com

Do you have any questions about our products?

We are always happy to take your call at +49 (571) 887-44222.



Item no.: 2020-215/000-037
2-conductor female connector; 1.5 mm²; 15-pole; 1,50 mm²; green-yellow, gray

www.wago.com/2020-215/000-037



Item no.: 2020-215/000-038
2-conductor female connector; 1.5 mm²; 15-pole; 1,50 mm²; gray, blue, green-yellow

www.wago.com/2020-215/000-038



Item no.: 2020-215/000-039
2-conductor female connector; 1.5 mm²; 15-pole; 1,50 mm²; green-yellow, blue, gray

www.wago.com/2020-215/000-039

Item no.: 2020-215/125-000
2-conductor female connector; Locking lever; 1.5 mm²; 15-pole; 1,50 mm²; gray

www.wago.com/2020-215/125-000

Item no.: 2020-215/135-000
2-conductor female connector; Strain relief plate; 1.5 mm²; 15-pole; 1,50 mm²; gray

www.wago.com/2020-215/135-000

Item no.: 2020-215/145-000
2-conductor female connector; Strain relief plate; 1.5 mm²; 15-pole; 1,50 mm²; gray

www.wago.com/2020-215/145-000

Downloads

Documentation

Additional Information

Technical explanations	Apr 3, 2019	pdf 2.1 MB	Download
------------------------	-------------	---------------	----------

CAD/CAE-Data

CAD data

2D/3D Models 2020-1401	URL	Download
------------------------	-----	----------

CAE data

EPLAN Data Portal 2020-1401	URL	Download
-----------------------------	-----	----------

WSCAD Universe 2020-1401	URL	Download
--------------------------	-----	----------

Installation Notes

Installation

Subject to changes. Please also observe the further product documentation!

WAGO Kontakttechnik GmbH & Co. KG
Hansastr. 27
32423 Minden
Phone: +49571 887-0 | Fax: +49571 887-169
Email: info.de@wago.com | Web: www.wago.com

Do you have any questions about our products?
We are always happy to take your call at +49 (571) 887-44222.

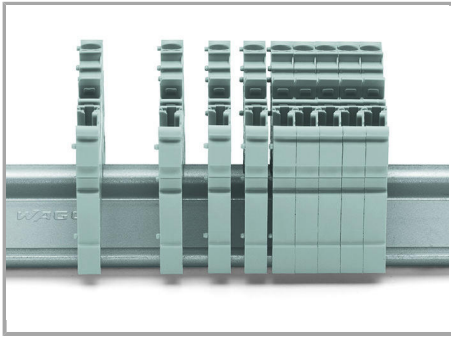

Snap individual carrier terminal blocks onto the carrier rail and slide together.

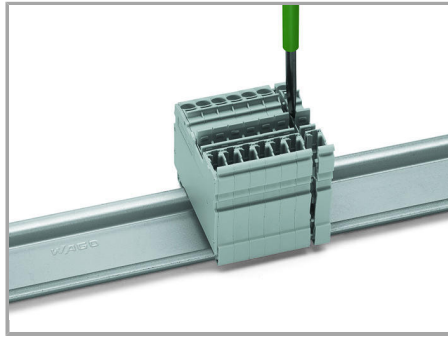

Open the assembly by laterally sliding a block via operating tool (3.5 x 0.5 mm blade).

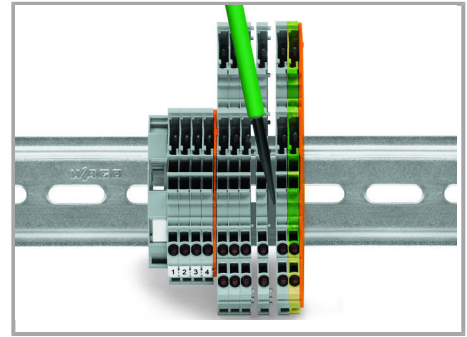

Separate terminal block assembly and slide individual terminal blocks laterally using an operating tool.

Inserting a conductor

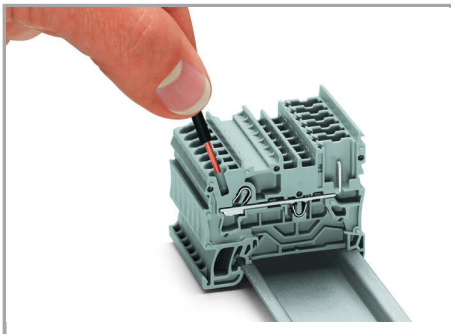

Push-in CAGE CLAMP® enables solid conductors and fine-stranded conductors with ferrules to be connected by simply pushing them into the unit.

Commoning

Subject to changes. Please also observe the further product documentation!

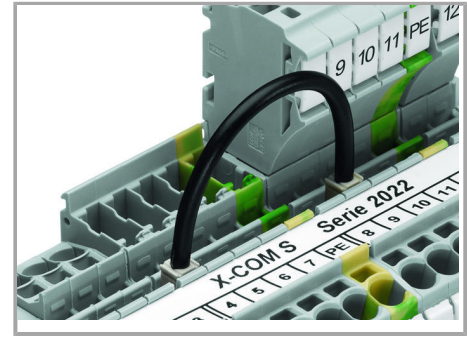
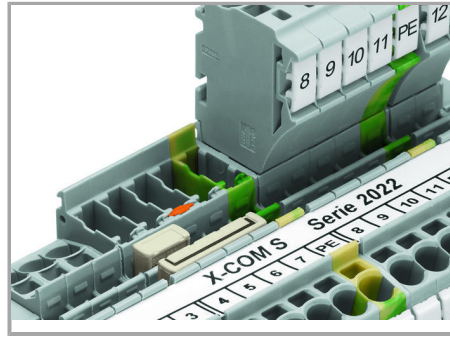
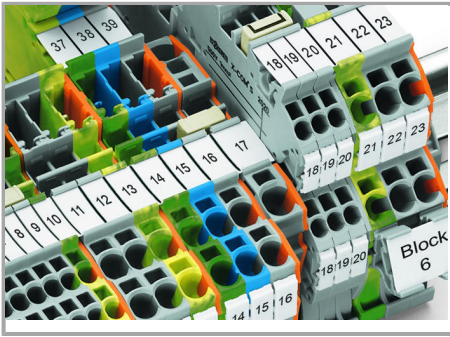

Commoning X-COM®S-SYSTEM Terminal Blocks using jumpers for TOPJOB® S Terminal Blocks. An end plate provides connection to TOPJOB® S Terminal Blocks. 2020 and 2022 Series Terminal Blocks are combinable. Jumper slots are on the same level for both series.

Pairing push-in comb style jumpers.

Commoning with push-in type wire jumper.

Testing

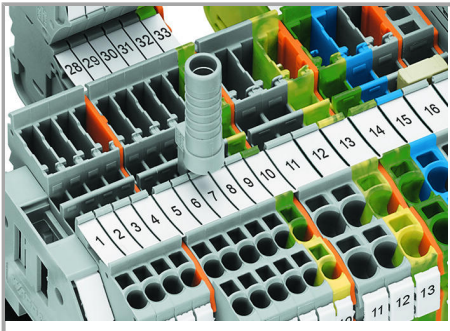

Test plug adapter (2009-174) for 4 mm test plugs or banana plugs – also suitable for X-COM®S-SYSTEM-MINI Terminal Blocks.

Coding

Subject to changes. Please also observe the further product documentation!

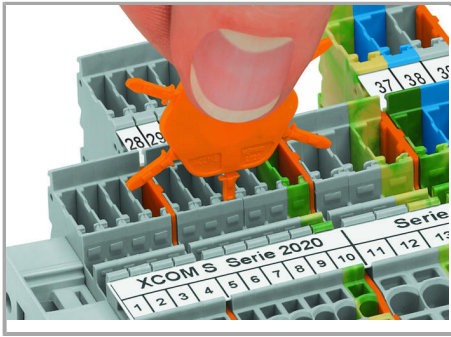

Insert coding pin into the corresponding slot and twist it off.



Coding a female plug: remove coding finger using a suitable tool.

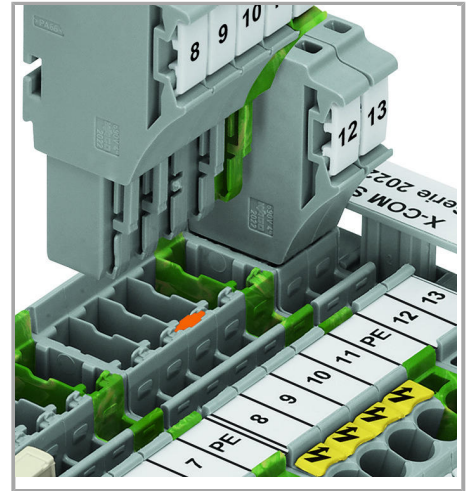

Insert a coding pin (2022-100) into the corresponding location of the carrier terminal block.

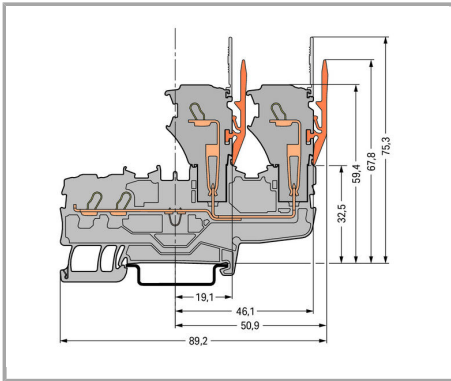

Carrier terminal block

Subject to changes. Please also observe the further product documentation!

WAGO Kontakttechnik GmbH & Co. KG
Hansastr. 27
32423 Minden
Phone: +49571 887-0 | Fax: +49571 887-169
Email: info.de@wago.com | Web: www.wago.com

Do you have any questions about our products?
We are always happy to take your call at +49 (571) 887-44222.

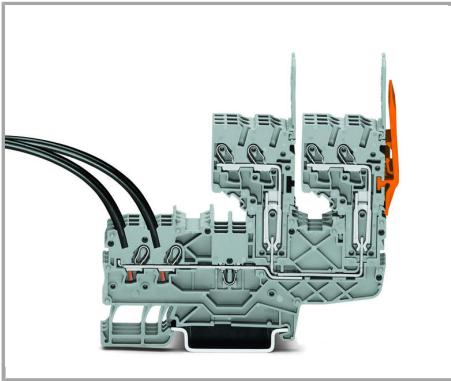

1-conductor female plug

Carrier terminal blocks can be commoned via 2000 Series Push-In Type Jumper Bars and tested via 859-500 Test Pin.

Marking

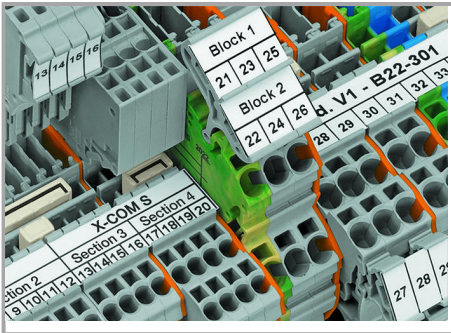

Clear marking via large marking area

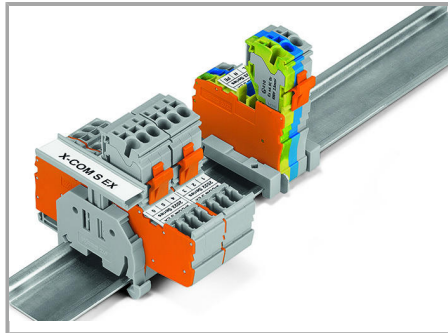

Group marking with height-adjustable group marker carrier (2009 163)

Safety

Subject to changes. Please also observe the further product documentation!

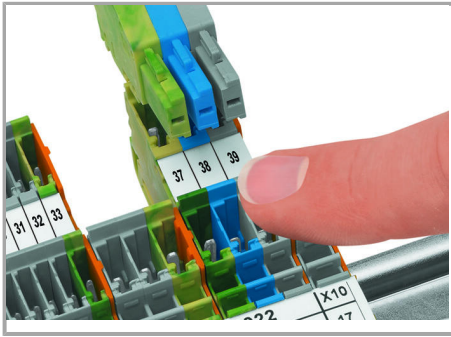

Carrier terminal blocks and female plugs are touch-proof.

Product family

X-COM S-Mini

[Show all products from the family](#)

Subject to changes. Please also observe the further product documentation!