

Data sheet | Item number: 2020-115

1-conductor female plug; 1.5 mm²; 15-pole; 1,50 mm²; gray

www.wago.com/2020-115

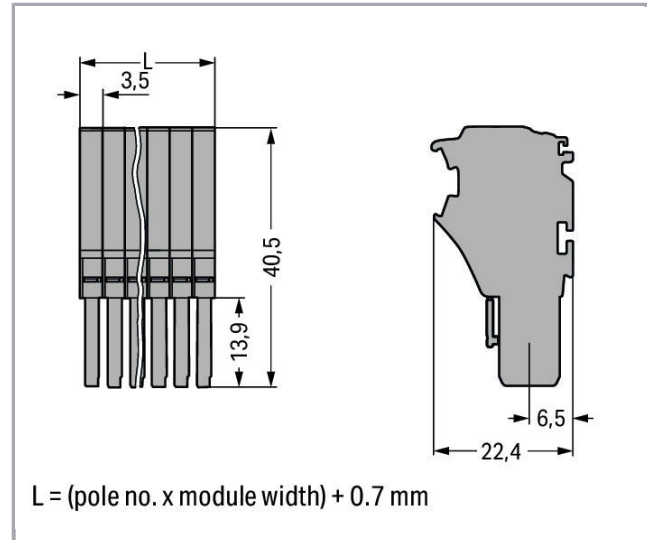
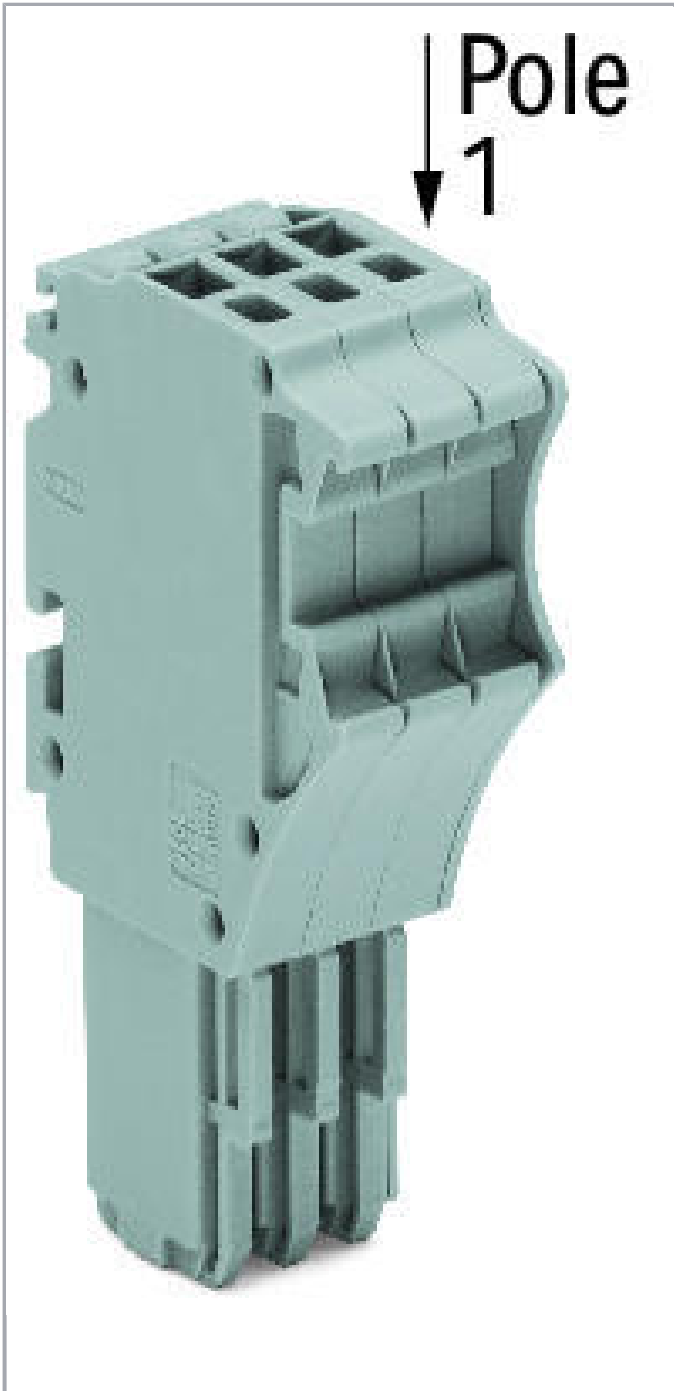

Subject to changes. Please also observe the further product documentation!

WAGO Kontakttechnik GmbH & Co. KG
Hansastr. 27
32423 Minden
Phone: +49571 887-0 | Fax: +49571 887-169
Email: info.de@wago.com | Web: www.wago.com

Do you have any questions about our products?
We are always happy to take your call at +49 (571) 887-44222.

RoHS 
Compliant

BOMcheck.net

Color: 

Item description

Safety information 1:

According to EN 61984, pluggable connectors without current interrupting capacity shall not be mated and unmated when live or under load.

Safety information 2:

Notice: An appropriate end plate must be applied to the carrier terminal blocks after each female plug.

Data

Electrical data

Ratings per IEC/EN 60664-1

Ratings per	IEC/EN 61984
Rated voltage (III / 3)	500 V
Rated impulse voltage (III / 3)	6 kV
Rated current	13.5 A
Legend (ratings)	(III / 3) $\hat{=}$ Overvoltage category III / Pollution degree 3

Approvals per UL 1059

Rated voltage UL (Use Group B)	300 V
Rated current UL (Use Group B)	15 A
Rated voltage UL (Use Group C)	300 V
Rated current UL (Use Group C)	15 A
Rated voltage UL (Use Group D)	300 V
Rated current UL (Use Group D)	15 A
Approvals per	UL 1059

Approvals per CSA

Rated voltage CSA (Use Group B)	300 V
Rated current CSA (Use Group B)	10 A
Rated voltage CSA (Use Group C)	300 V
Rated current CSA (Use Group C)	10 A

Subject to changes. Please also observe the further product documentation!



Connection data

Connection technology	Push-in CAGE CLAMP®
Actuation type	Open Tool Slot Push-in
Connectable conductor materials	Copper
Nominal cross section	1 mm ²
Solid conductor	0.14 ... 1.5 mm ² / 24 ... 16 AWG
Solid conductor, push-in termination	0.5 ... 1.5 mm ² / 20 ... 16 AWG
Fine-stranded conductor	0.14 ... 1.5 mm ² / 24 ... 16 AWG
Fine-stranded conductor with ferrule with plastic collar	0.5 ... 0.75 mm ² / 20 ... 18 AWG
Fine-stranded conductor with ferrule, push-in termination, from	0.5 ... 0.75 mm ² / 20 ... 18 AWG
Strip length	9 ... 11 mm / 0.35 ... 0.43 inch
No. of poles	15
Total number of connection points	15
Total number of potentials	15
Type of wiring	Front-entry wiring
Note (conductor cross-section)	Depending on the conductor characteristic, a conductor with a smaller cross section can also be inserted via push-in termination.

Geometrical Data

Width	53.2 mm / 2.094 inch
Height	40.5 mm / 1.594 inch
Depth	22.4 mm / 0.882 inch
Module width	3.5 mm / 0.138 inch

Mechanical data

Marking level	Side marking
---------------	--------------

Plug connection

Contact type (pluggable connector)	Female connector/socket
Connector connection type	for conductors

Material Data

Color	gray
Insulating material	Polyamide 66 (PA 66)
Fire load	0.598 MJ

Subject to changes. Please also observe the further product documentation!



Weight	33.8g
--------	-------

Commercial data



Packaging type	BOX
Country of origin	CN
GTIN	4050821245124
Customs Tariff No.	85366990990

Approvals / Certificates

Country specific Approvals

Logo	Approval	Additional Approval Text	Certificate name
	CCA DEKRA Certification B.V.	EN 60947	NTR NL 7617
	CSA DEKRA Certification B.V.	C22.2 No. 158	2516073

Ship Approvals

Logo	Approval	Additional Approval Text	Certificate name
	ABS American Bureau of Shipping	EN 60947	20- HG1941090- PDA
	BV Bureau Veritas S.A.	EN 60947	38586/A0 BV
	LR Lloyds Register	EN 60947	91/20112 (E9)

UL-Approvals

Logo	Approval	Additional Approval Text	Certificate name
	UL UL International Germany GmbH	UL 1059	E45172



Subject to changes. Please also observe the further product documentation!





Counterpart

Compatible products



Locking lever

	Item no.: 2022-141 Locking lever; can be snapped on 1-conductor female plugs; for 1-pole female plugs; gray	www.wago.com/2022-141
	Item no.: 2022-142 Locking lever; can be snapped on 1-conductor female plugs; for 1-pole female plugs; orange	www.wago.com/2022-142
	Item no.: 2022-151 Locking lever; can be snapped on 1-conductor female plugs; 2 poles and more; gray	www.wago.com/2022-151
	Item no.: 2022-152 Locking lever; can be snapped on 1-conductor female plugs; 2 poles and more; orange	www.wago.com/2022-152

ferrule

	Item no.: 216-241 Ferrule; Sleeve for 0.5 mm ² / 20 AWG; insulated; electro-tin plated; electrolytic copper; gastight crimped; acc. to DIN 46228, Part 4/09.90; white	www.wago.com/216-241
	Item no.: 216-242 Ferrule; Sleeve for 0.75 mm ² / 18 AWG; insulated; electro-tin plated; electrolytic copper; gastight crimped; acc. to DIN 46228, Part 4/09.90; gray	www.wago.com/216-242
	Item no.: 216-243 Ferrule; Sleeve for 1 mm ² / AWG 18; insulated; electro-tin plated; electrolytic copper; gastight crimped; acc. to DIN 46228, Part 4/09.90; red	www.wago.com/216-243

Marking accessories

	Item no.: 2009-110 Marking strips; on reel; not stretchable; plain; snap-on type; white	www.wago.com/2009-110
	Item no.: 2009-113 WMB-Inline; for Smart Printer; 2300 pieces on roll; plain; snap-on type; white	www.wago.com/2009-113
	Item no.: 2009-113/000-002 WMB-Inline; for Smart Printer; 2300 pieces on roll; plain; snap-on type; yellow	www.wago.com/2009-113/000-002

Subject to changes. Please also observe the further product documentation!

	Item no.: 2009-113/000-005 WMB-Inline; for Smart Printer; 2300 pieces on roll; plain; snap-on type; red	www.wago.com/2009-113/000-005
----------------------------------------------------------------------------------	-------------------------------------------------------------------------------------------------------------------	----------------------------------------------------------------------------------

	Item no.: 2009-113/000-006 WMB-Inline; for Smart Printer; 2300 pieces on roll; plain; snap-on type; blue	www.wago.com/2009-113/000-006
--	--------------------------------------------------------------------------------------------------------------------	----------------------------------------------------------------------------------

	Item no.: 2009-113/000-007 WMB-Inline; for Smart Printer; 2300 pieces on roll; plain; snap-on type; gray	www.wago.com/2009-113/000-007
--	--------------------------------------------------------------------------------------------------------------------	----------------------------------------------------------------------------------

	Item no.: 2009-113/000-012 WMB-Inline; for Smart Printer; 2300 pieces on roll; plain; snap-on type; orange	www.wago.com/2009-113/000-012
----------------------------------------------------------------------------------	----------------------------------------------------------------------------------------------------------------------	----------------------------------------------------------------------------------

	Item no.: 2009-113/000-017 WMB-Inline; for Smart Printer; 2300 pieces on roll; plain; snap-on type; light green	www.wago.com/2009-113/000-017
--	---------------------------------------------------------------------------------------------------------------------------	----------------------------------------------------------------------------------

	Item no.: 2009-113/000-023 WMB-Inline; for Smart Printer; 2300 pieces on roll; plain; snap-on type; green	www.wago.com/2009-113/000-023
--	---------------------------------------------------------------------------------------------------------------------	----------------------------------------------------------------------------------

	Item no.: 2009-113/000-024 WMB-Inline; for Smart Printer; 2300 pieces on roll; plain; snap-on type; violet	www.wago.com/2009-113/000-024
-----------------------------------------------------------------------------------	----------------------------------------------------------------------------------------------------------------------	----------------------------------------------------------------------------------

	Item no.: 210-831 Marking strips; on reel; 2.3 mm wide; plain; Self-adhesive; white	www.wago.com/210-831
------------------------------------------------------------------------------------	-----------------------------------------------------------------------------------------------	----------------------------------------------------------------

	Item no.: 210-832 Marking strips; on reel; 3 mm wide; plain; Self-adhesive; white	www.wago.com/210-832
------------------------------------------------------------------------------------	---------------------------------------------------------------------------------------------	----------------------------------------------------------------

	Item no.: 210-833 Marking strips; on reel; 6 mm wide; plain; Self-adhesive; white	www.wago.com/210-833
------------------------------------------------------------------------------------	---------------------------------------------------------------------------------------------	----------------------------------------------------------------

	Item no.: 210-834 Marking strips; on reel; 5 mm wide; plain; Self-adhesive; white	www.wago.com/210-834
--	---------------------------------------------------------------------------------------------	----------------------------------------------------------------

	Item no.: 793-3501 WMB marking card; as card; plain; snap-on type; white	www.wago.com/793-3501
------------------------------------------------------------------------------------	------------------------------------------------------------------------------------	------------------------------------------------------------------

Protective Warning Marker

	Item no.: 2000-115 Protective warning marker; with high-voltage symbol, black; for 5 terminal blocks; yellow	www.wago.com/2000-115
------------------------------------------------------------------------------------	------------------------------------------------------------------------------------------------------------------------	------------------------------------------------------------------

tools

	Item no.: 210-647 Operating tool; Blade: 2.5 x 0.4 mm; with a partially insulated shaft	www.wago.com/210-647
--	---------------------------------------------------------------------------------------------------	----------------------------------------------------------------

	Item no.: 210-648 Operating tool; Blade: 2.5 x 0.4 mm; with a partially insulated shaft; angled; short	www.wago.com/210-648
--	------------------------------------------------------------------------------------------------------------------	----------------------------------------------------------------

Subject to changes. Please also observe the further product documentation!



Item no.: 210-719

Operating tool; Blade: 2.5 x 0.4 mm; with a partially insulated shaft

www.wago.com/210-719

Strain relief plate



Item no.: 734-326

Strain relief plate; gray

www.wago.com/734-326



Item no.: 734-327

Strain relief plate; gray

www.wago.com/734-327



Item no.: 734-329

Strain relief plate; gray

www.wago.com/734-329

Downloads

Documentation

Additional Information

Technical explanations

Apr 3, 2019

pdf
2.1 MB

Download

CAD/CAE-Data

CAD data

2D/3D Models 2020-115

URL

Download

CAE data

EPLAN Data Portal 2020-115

URL

Download

WSCAD Universe 2020-115

URL

Download

Installation Notes

Coding

Subject to changes. Please also observe the further product documentation!

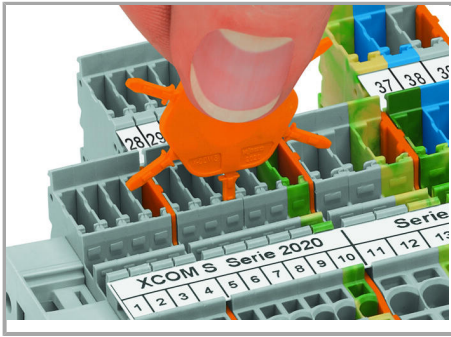

Insert coding pin into the corresponding slot and twist it off.



Coding a female plug: remove coding finger using a suitable tool.

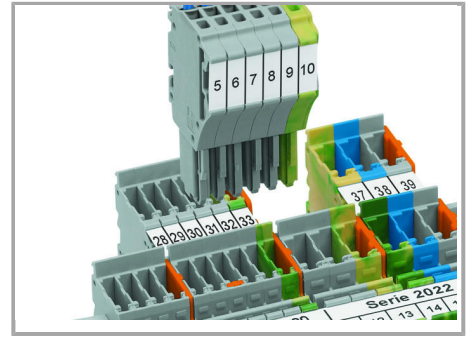

Insert coded female connector into X-COM®S-SYSTEM terminal block assembly.

Locking lever

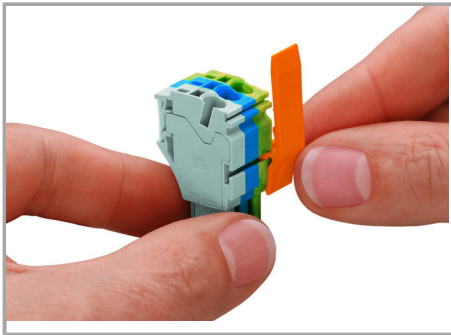

Slide the locking lever into position.

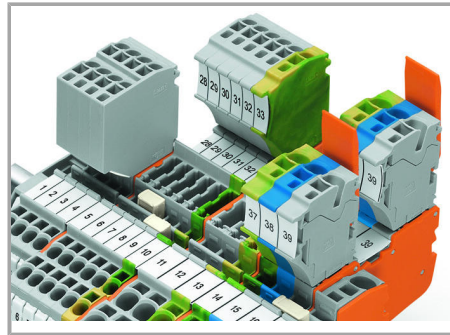

Female plugs can be individually locked.

Product family

X-COM S-Mini

[Show all products from the family](#)

Subject to changes. Please also observe the further product documentation!