

Data sheet | Item number: 2020-105

1-conductor female plug; 1.5 mm<sup>2</sup>; 5-pole; 1,50 mm<sup>2</sup>; gray

[www.wago.com/2020-105](http://www.wago.com/2020-105)

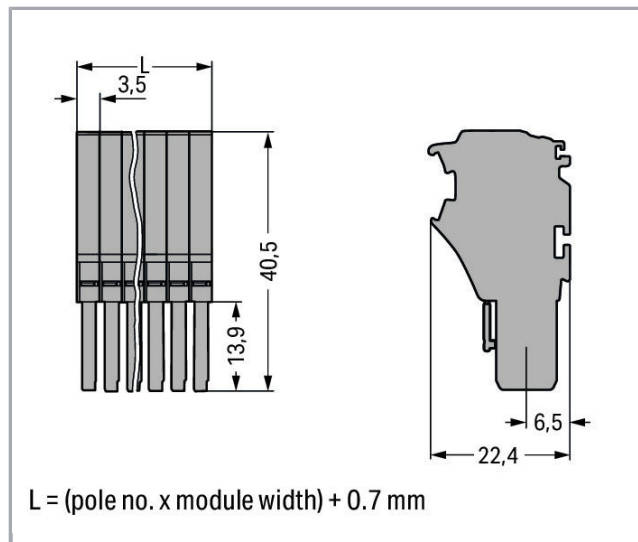
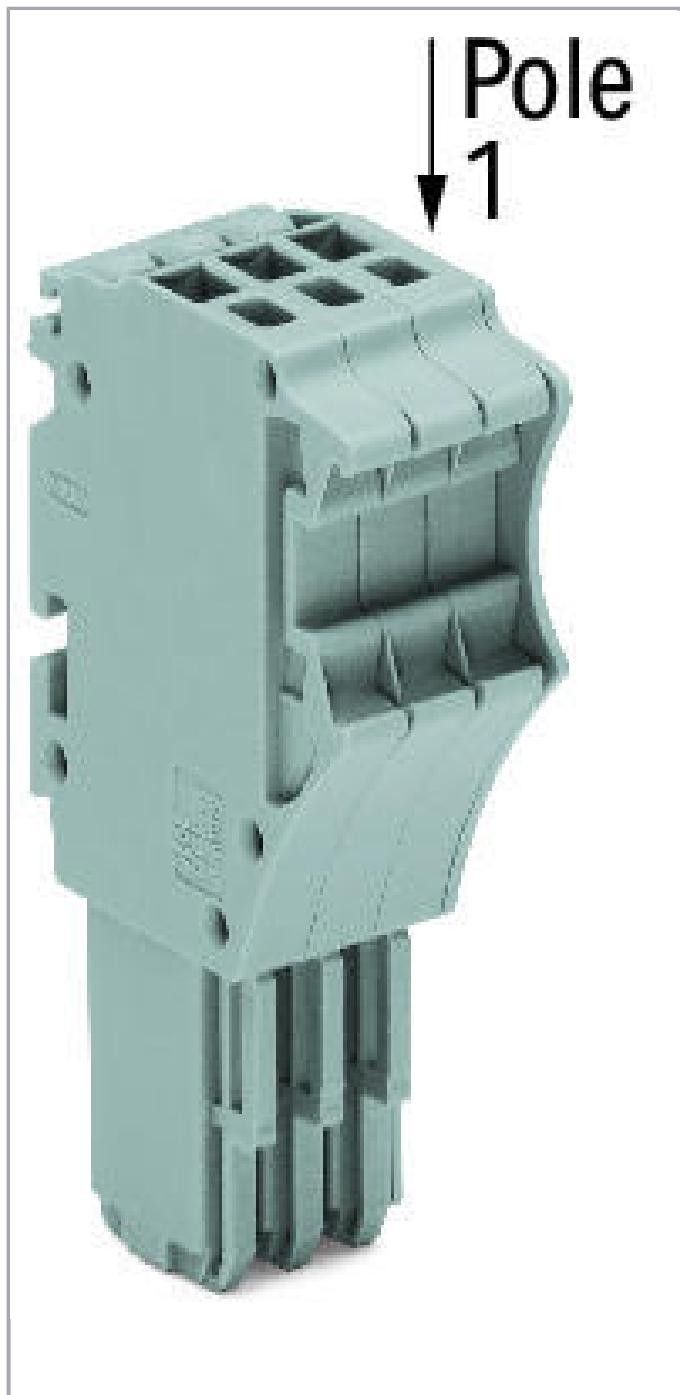

Subject to changes. Please also observe the further product documentation!

WAGO Kontakttechnik GmbH & Co. KG  
Hansastr. 27  
32423 Minden  
Phone: +49571 887-0 | Fax: +49571 887-169  
Email: [info.de@wago.com](mailto:info.de@wago.com) | Web: [www.wago.com](http://www.wago.com)

Do you have any questions about our products?  
We are always happy to take your call at +49 (571) 887-44222.

RoHS   
Compliant

BOMcheck.net

Color: 

## Item description

### Safety information 1:

According to EN 61984, pluggable connectors without current interrupting capacity shall not be mated and unmated when live or under load.

### Safety information 2:

Notice: An appropriate end plate must be applied to the carrier terminal blocks after each female plug.

## Data

### Electrical data

#### Ratings per IEC/EN 60664-1

Ratings per	IEC/EN 61984
Rated voltage (III / 3)	500 V
Rated impulse voltage (III / 3)	6 kV
Rated current	13.5 A
Legend (ratings)	(III / 3) $\hat{=}$ Overvoltage category III / Pollution degree 3

#### Approvals per UL 1059

Rated voltage UL (Use Group B)	300 V
Rated current UL (Use Group B)	15 A
Rated voltage UL (Use Group C)	300 V
Rated current UL (Use Group C)	15 A
Rated voltage UL (Use Group D)	300 V
Rated current UL (Use Group D)	15 A
Approvals per	UL 1059

#### Approvals per CSA

Rated voltage CSA (Use Group B)	300 V
Rated current CSA (Use Group B)	10 A
Rated voltage CSA (Use Group C)	300 V
Rated current CSA (Use Group C)	10 A

Subject to changes. Please also observe the further product documentation!



## Connection data

Connection technology	Push-in CAGE CLAMP®
Actuation type	Open Tool Slot Push-in
Connectable conductor materials	Copper
Nominal cross section	1 mm <sup>2</sup>
Solid conductor	0,14 ... 1,5 mm <sup>2</sup> / 24 ... 16 AWG
Solid conductor, push-in termination	0,5 ... 1,5 mm <sup>2</sup> / 20 ... 16 AWG
Fine-stranded conductor	0,14 ... 1,5 mm <sup>2</sup> / 24 ... 16 AWG
Fine-stranded conductor with ferrule with plastic collar	0,5 ... 0,75 mm <sup>2</sup> / 20 ... 18 AWG
Fine-stranded conductor with ferrule, push-in termination, from	0,5 ... 0,75 mm <sup>2</sup> / 20 ... 18 AWG
Strip length	9 ... 11 mm / 0.35 ... 0.43 inch
No. of poles	5
Total number of connection points	5
Total number of potentials	5
Type of wiring	Front-entry wiring
Note (conductor cross-section)	Depending on the conductor characteristic, a conductor with a smaller cross section can also be inserted via push-in termination.

## Geometrical Data

Width	18,2 mm / 0.717 inch
Height	40,5 mm / 1.594 inch
Depth	22,4 mm / 0.882 inch
Module width	3,5 mm / 0.138 inch

## Mechanical data

Marking level	Side marking
---------------	--------------

## Plug connection

Contact type (pluggable connector)	Female connector/socket
Connector connection type	for conductors

## Material Data

Color	gray
Insulating material	Polyamide 66 (PA 66)
Fire load	0.208 MJ

Subject to changes. Please also observe the further product documentation!



Weight	11.6 g
--------	--------

### Commercial data





Packaging type	BOX
Country of origin	CN
GTIN	4050821245063
Customs Tariff No.	85366990990

### Approvals / Certificates

#### Country specific Approvals

Logo	Approval	Additional Approval Text	Certificate name
	CCA DEKRA Certification B.V.	EN 60947	NTR NL 7617
	CSA DEKRA Certification B.V.	C22.2 No. 158	2516073

#### Ship Approvals

Logo	Approval	Additional Approval Text	Certificate name
	ABS American Bureau of Shipping	EN 60947	20- HG1941090- PDA
	BV Bureau Veritas S.A.	EN 60947	38586/A0 BV
	DNV GL Det Norske Veritas, Germanischer Lloyd	-	TAE00001V2
	LR Lloyds Register	EN 60947	91/20112 (E9)

#### UL-Approvals

Subject to changes. Please also observe the further product documentation!



WAGO Kontakttechnik GmbH & Co. KG  
 Hansastr. 27  
 32423 Minden  
 Phone: +49571 887-0 | Fax: +49571 887-169  
 Email: [info.de@wago.com](mailto:info.de@wago.com) | Web: [www.wago.com](http://www.wago.com)

Do you have any questions about our products?  
 We are always happy to take your call at +49 (571) 887-44222.







Logo	Approval	Additional Approval Text	Certificate name
	UL UL International Germany GmbH	UL 1059	E45172

## Counterpart

## Compatible products

<b>ferrule</b>			
	<b>Item no.: 216-241</b> Ferrule; Sleeve for 0.5 mm <sup>2</sup> / 20 AWG; insulated; electro-tin plated; electrolytic copper; gastight crimped; acc. to DIN 46228, Part 4/09.90; white		<a href="http://www.wago.com/216-241">www.wago.com/216-241</a>
	<b>Item no.: 216-242</b> Ferrule; Sleeve for 0.75 mm <sup>2</sup> / 18 AWG; insulated; electro-tin plated; electrolytic copper; gastight crimped; acc. to DIN 46228, Part 4/09.90; gray		<a href="http://www.wago.com/216-242">www.wago.com/216-242</a>
	<b>Item no.: 216-243</b> Ferrule; Sleeve for 1 mm <sup>2</sup> / AWG 18; insulated; electro-tin plated; electrolytic copper; gastight crimped; acc. to DIN 46228, Part 4/09.90; red		<a href="http://www.wago.com/216-243">www.wago.com/216-243</a>
<b>Locking lever</b>			
	<b>Item no.: 2022-141</b> Locking lever; can be snapped on 1-conductor female plugs; for 1-pole female plugs; gray		<a href="http://www.wago.com/2022-141">www.wago.com/2022-141</a>
	<b>Item no.: 2022-142</b> Locking lever; can be snapped on 1-conductor female plugs; for 1-pole female plugs; orange		<a href="http://www.wago.com/2022-142">www.wago.com/2022-142</a>
	<b>Item no.: 2022-151</b> Locking lever; can be snapped on 1-conductor female plugs; 2 poles and more; gray		<a href="http://www.wago.com/2022-151">www.wago.com/2022-151</a>
	<b>Item no.: 2022-152</b> Locking lever; can be snapped on 1-conductor female plugs; 2 poles and more; orange		<a href="http://www.wago.com/2022-152">www.wago.com/2022-152</a>
<b>Strain relief plate</b>			
	<b>Item no.: 734-328</b> Strain relief plate; gray		<a href="http://www.wago.com/734-328">www.wago.com/734-328</a>
<b>Marking accessories</b>			
	<b>Item no.: 2009-110</b> Marking strips; on reel; not stretchable; plain; snap-on type; white		<a href="http://www.wago.com/2009-110">www.wago.com/2009-110</a>

Subject to changes. Please also observe the further product documentation!

	<b>Item no.: 2009-113</b> WMB-Inline; for Smart Printer; 2300 pieces on roll; plain; snap-on type; white	<a href="http://www.wago.com/2009-113">www.wago.com/2009-113</a>
	<b>Item no.: 2009-113/000-002</b> WMB-Inline; for Smart Printer; 2300 pieces on roll; plain; snap-on type; yellow	<a href="http://www.wago.com/2009-113/000-002">www.wago.com/2009-113/000-002</a>
	<b>Item no.: 2009-113/000-005</b> WMB-Inline; for Smart Printer; 2300 pieces on roll; plain; snap-on type; red	<a href="http://www.wago.com/2009-113/000-005">www.wago.com/2009-113/000-005</a>
	<b>Item no.: 2009-113/000-006</b> WMB-Inline; for Smart Printer; 2300 pieces on roll; plain; snap-on type; blue	<a href="http://www.wago.com/2009-113/000-006">www.wago.com/2009-113/000-006</a>
	<b>Item no.: 2009-113/000-007</b> WMB-Inline; for Smart Printer; 2300 pieces on roll; plain; snap-on type; gray	<a href="http://www.wago.com/2009-113/000-007">www.wago.com/2009-113/000-007</a>
	<b>Item no.: 2009-113/000-012</b> WMB-Inline; for Smart Printer; 2300 pieces on roll; plain; snap-on type; orange	<a href="http://www.wago.com/2009-113/000-012">www.wago.com/2009-113/000-012</a>
	<b>Item no.: 2009-113/000-017</b> WMB-Inline; for Smart Printer; 2300 pieces on roll; plain; snap-on type; light green	<a href="http://www.wago.com/2009-113/000-017">www.wago.com/2009-113/000-017</a>
	<b>Item no.: 2009-113/000-023</b> WMB-Inline; for Smart Printer; 2300 pieces on roll; plain; snap-on type; green	<a href="http://www.wago.com/2009-113/000-023">www.wago.com/2009-113/000-023</a>
	<b>Item no.: 2009-113/000-024</b> WMB-Inline; for Smart Printer; 2300 pieces on roll; plain; snap-on type; violet	<a href="http://www.wago.com/2009-113/000-024">www.wago.com/2009-113/000-024</a>
	<b>Item no.: 210-831</b> Marking strips; on reel; 2.3 mm wide; plain; Self-adhesive; white	<a href="http://www.wago.com/210-831">www.wago.com/210-831</a>
	<b>Item no.: 210-832</b> Marking strips; on reel; 3 mm wide; plain; Self-adhesive; white	<a href="http://www.wago.com/210-832">www.wago.com/210-832</a>
	<b>Item no.: 210-833</b> Marking strips; on reel; 6 mm wide; plain; Self-adhesive; white	<a href="http://www.wago.com/210-833">www.wago.com/210-833</a>
	<b>Item no.: 210-834</b> Marking strips; on reel; 5 mm wide; plain; Self-adhesive; white	<a href="http://www.wago.com/210-834">www.wago.com/210-834</a>
	<b>Item no.: 793-3501</b> WMB marking card; as card; plain; snap-on type; white	<a href="http://www.wago.com/793-3501">www.wago.com/793-3501</a>
<b>Protective Warning Marker</b>		
	<b>Item no.: 2000-115</b> Protective warning marker; with high-voltage symbol, black; for 5 terminal blocks; yellow	<a href="http://www.wago.com/2000-115">www.wago.com/2000-115</a>

Subject to changes. Please also observe the further product documentation!

tools

	<p><b>Item no.: 210-647</b> Operating tool; Blade: 2.5 x 0.4 mm; with a partially insulated shaft</p>	<p><a href="http://www.wago.com/210-647">www.wago.com/210-647</a></p>
	<p><b>Item no.: 210-648</b> Operating tool; Blade: 2.5 x 0.4 mm; with a partially insulated shaft; angled; short</p>	<p><a href="http://www.wago.com/210-648">www.wago.com/210-648</a></p>
	<p><b>Item no.: 210-719</b> Operating tool; Blade: 2.5 x 0.4 mm; with a partially insulated shaft</p>	<p><a href="http://www.wago.com/210-719">www.wago.com/210-719</a></p>

Downloads

Documentation

Additional Information

<p>Technical explanations</p>	<p>Apr 3, 2019</p>	<p>pdf 2.1 MB</p>	<p>Download</p>
-------------------------------	--------------------	-----------------------	-----------------

CAD/CAE-Data

CAD data

<p>2D/3D Models 2020-105</p>	<p>URL</p>	<p>Download</p>
------------------------------	------------	-----------------

CAE data

<p>EPLAN Data Portal 2020-105</p>	<p>URL</p>	<p>Download</p>
-----------------------------------	------------	-----------------

<p>WSCAD Universe 2020-105</p>	<p>URL</p>	<p>Download</p>
--------------------------------	------------	-----------------

Installation Notes

Coding

Subject to changes. Please also observe the further product documentation!

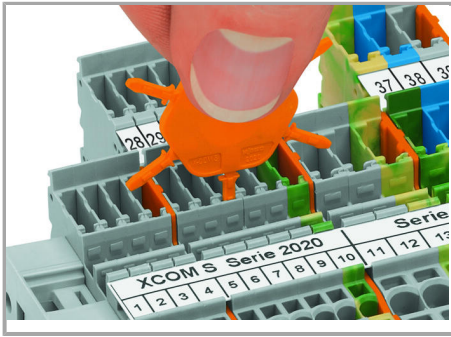

Insert coding pin into the corresponding slot and twist it off.



Coding a female plug: remove coding finger using a suitable tool.

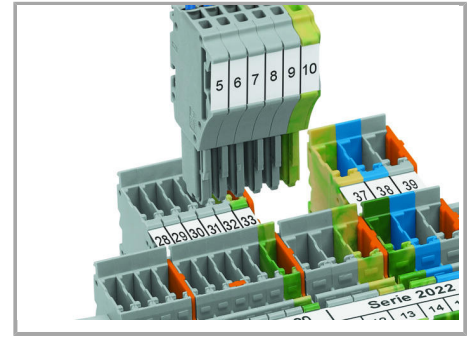

Insert coded female connector into X-COM®S-SYSTEM terminal block assembly.

### Locking lever

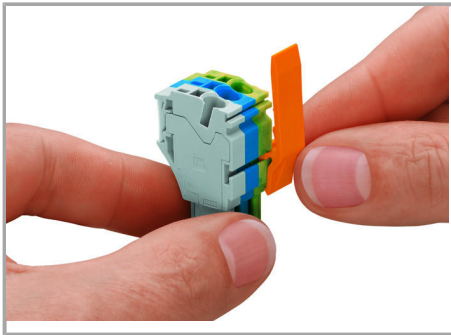

Slide the locking lever into position.

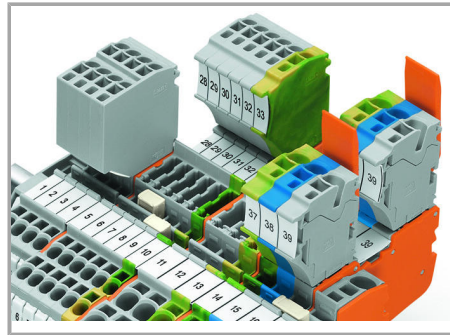

Female plugs can be individually locked.

### Product family

**X-COM S-Mini**

[Show all products from the family](#)

Subject to changes. Please also observe the further product documentation!