

Data sheet | Item number: 2004-433

Push-in type jumper bar; insulated; from 1 to 3; Nominal current 32 A; light gray

www.wago.com/2004-433



Data

Electrical data

Ratings per IEC/EN 60664-1

Rated voltage (III / 3)	800 V
Rated current	32 A

Subject to changes. Please also observe the further product documentation!

WAGO Kontakttechnik GmbH & Co. KG
Hansastr. 27
32423 Minden
Phone: +49571 887-0 | Fax: +49571 887-169
Email: info.de@wago.com | Web: www.wago.com

Do you have any questions about our products?
We are always happy to take your call at +49 (571) 887-44222.



Approvals Ex

Rated current (Ex e II)	30 A
-------------------------	------

Geometrical Data

Width	16,5 mm / 0.65 inch
Height	19 mm / 0.748 inch
Depth	4,1 mm / 0.161 inch

Material Data

Color	light gray
Fire load	0.01 MJ
Weight	1.8 g

Commercial data

Product Group	22 (TOPJOB S)
Packaging type	bag
Country of origin	DE
GTIN	4044918583077
Customs Tariff No.	85366990990

Counterpart

Downloads

Documentation

Additional Information

Technical explanations	Apr 3, 2019	pdf 2.1 MB	Download
------------------------	-------------	---------------	----------

CAD/CAE-Data

CAD data

2D/3D Models 2004-433	URL	Download
-----------------------	-----	----------

CAE data

EPLAN Data Portal 2004-433	URL	Download
----------------------------	-----	----------

Subject to changes. Please also observe the further product documentation!

Installation Notes

Jumpered

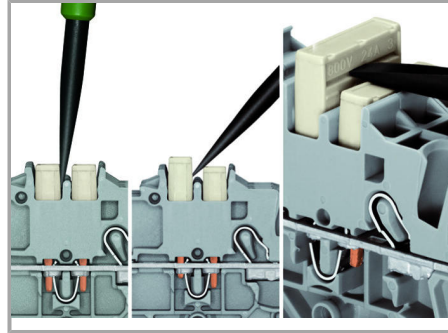
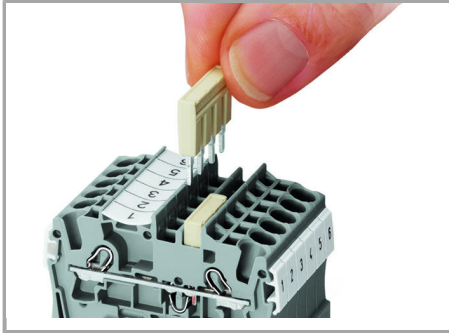

The push-in type jumper bar system is based on the common plug and socket principle. Each terminal block is spring-loaded with a double socket and a resilient CrNi steel spring. The jumper contact material is pure electrolytic copper, which allows for an extremely small design capable of carrying the full-rated current of the terminal block. Ground terminal blocks can also be commoned using the same jumper system. Custom jumpers are created by breaking and removing jumper contacts (2000, 2001, 2002, 2004 Series).

Removing a push-in type jumper bar.

Insert the operating tool between the jumper and the partition wall of the dual jumper slots, then lift up the jumper.

Place the operating tool in the center of jumpers up to five contacts (see above), or alternately on both sides for jumpers with more than five contacts.

Jumpered

Subject to changes. Please also observe the further product documentation!

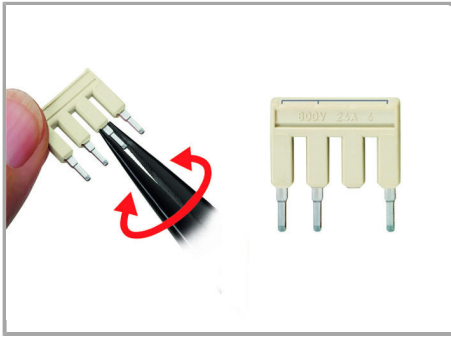

Custom push-in type jumper bars are created by breaking off jumper contacts.

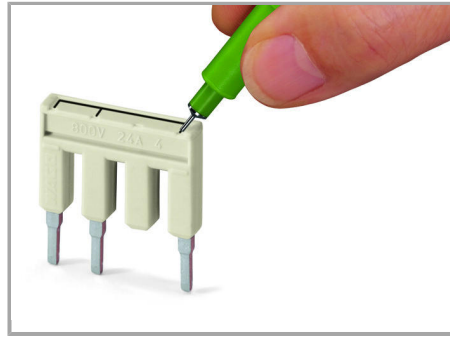

Marking a push-in type jumper bar using a felt-tip pen.

500 V

300 V

Jumpered

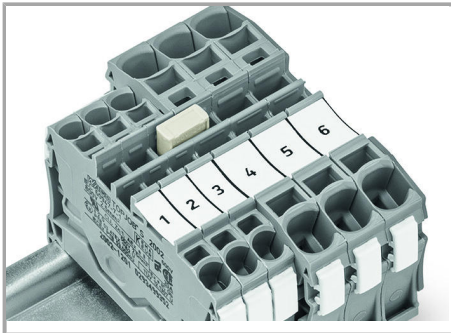

Stepping down via push-in type jumper bar.

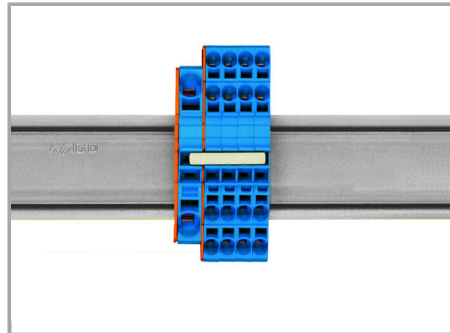

Stepping down via push-in type jumper bar.

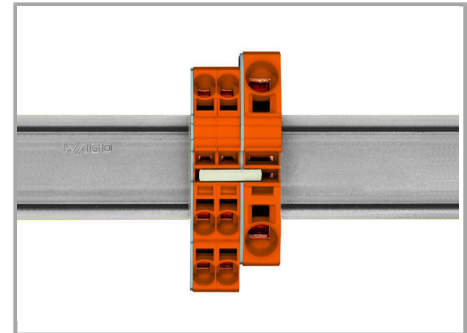

Stepping down via push-in type jumper bar.

Commoning via closed terminal side with end plate allows jumpering over two cross-section sizes, e.g., from 16 mm² (6 AWG) to 6 mm² (10 AWG) or from 6 mm² (10 AWG) to 2.5 mm² (14 AWG) (see illustration above).

Commoning via open terminal side with end plate allows jumpering over two cross-section sizes for 16 mm² (6 AWG) and 10 mm² (8 AWG) and one cross-section size for 6/4/2.5 mm² (10/12/14 AWG). An example: from 16 mm² (6 AWG) to 6 mm² (10 AWG) (see illustration above) or from 10 mm² (8 AWG) to 4 mm² (12 AWG).

Subject to changes. Please also observe the further product documentation!

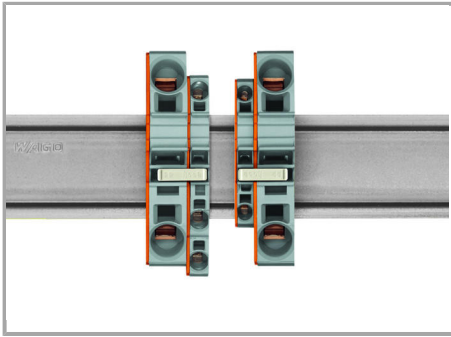

Note:

The total current of the outgoing circuits shall not exceed the nominal current of the step-down jumper/push-in type jumper bar.

Product family

TOPJOB® S

TOPJOB® S: In various industrial applications and modern building installations, WAGO's wide and versatile range of rail-mount terminal blocks provides more than just reliable electrical connections.

[Learn more about the product family.](#)

[Show all products from the family](#)

Subject to changes. Please also observe the further product documentation!