

Data sheet | Item number: 2003-911

Double fuse plug; for 5 x 20 mm miniature metric fuse; without blown fuse indication; 10.4 mm wide; gray

www.wago.com/2003-911

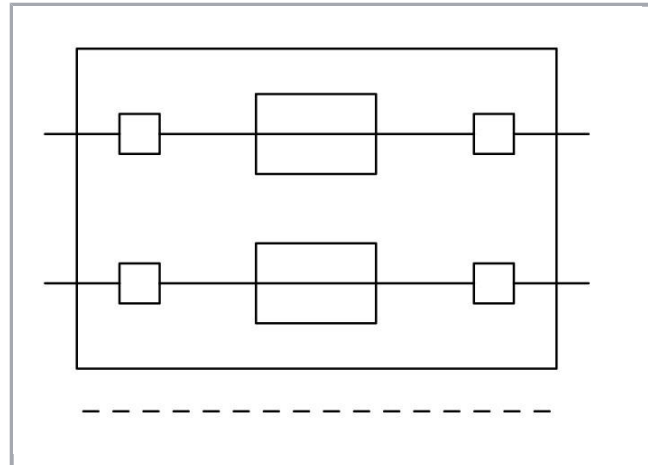
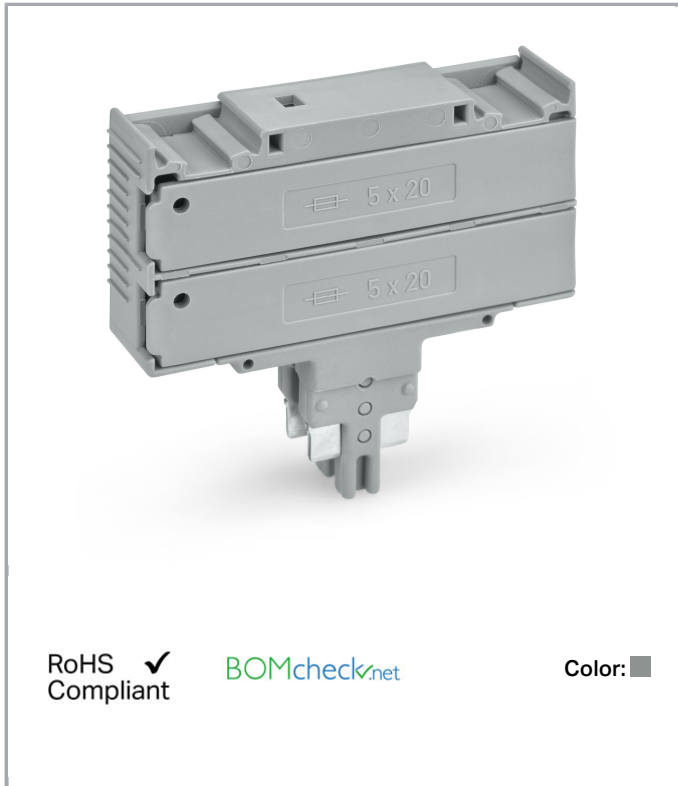

Item description

Safety information 1:

Electrical ratings are given by the fuse.

Data

Electrical data

Ratings per IEC/EN 60664-1

Rated voltage (III / 3)	250 V
Rated current	6.3 A

Subject to changes. Please also observe the further product documentation!

WAGO Kontakttechnik GmbH & Co. KG
Hansastr. 27
32423 Minden
Phone: +49571 887-0 | Fax: +49571 887-169
Email: info.de@wago.com | Web: www.wago.com

Do you have any questions about our products?
We are always happy to take your call at +49 (571) 887-44222.

Approvals per UL 1059

Rated voltage UL (Use Group B)	250 V
Rated current UL (Use Group B)	6.3 A
Rated voltage UL (Use Group C)	250 V
Rated current UL (Use Group C)	6.3 A
Approvals per	UL 1059

Geometrical Data

Width	10,4 mm / 0.409 inch
-------	----------------------

Mechanical data

Marking level	Center marking
---------------	----------------

Material Data

Color	gray
Fire load	0.171 MJ
Weight	12.1 g

Commercial data

Product Group	22 (TOPJOB S)
Packaging type	BOX
Country of origin	DE
GTIN	4050821270416
Customs Tariff No.	85366990990

Approvals / Certificates

UL-Approvals







Logo	Approval	Additional Approval Text	Certificate name
	UL Underwriters Laboratories Inc.	UL 1059	20190402- E45172

Subject to changes. Please also observe the further product documentation!

Counterpart

Compatible products

Marking accessories

	Item no.: 2009-110 Marking strips; on reel; not stretchable; plain; snap-on type; white	www.wago.com/2009-110
	Item no.: 2009-115 WMB-Inline; for Smart Printer; 1500 pieces on roll; stretchable 5 - 5.2 mm; plain; snap-on type; white	www.wago.com/2009-115
	Item no.: 2009-115/000-002 WMB-Inline; for Smart Printer; 1500 pieces on roll; stretchable 5 - 5.2 mm; plain; snap-on type; yellow	www.wago.com/2009-115/000-002
	Item no.: 2009-115/000-006 WMB-Inline; for Smart Printer; 1500 pieces on roll; stretchable 5 - 5.2 mm; plain; snap-on type; white	www.wago.com/2009-115/000-006
	Item no.: 2009-115/000-007 WMB-Inline; for Smart Printer; 1500 pieces on roll; stretchable 5 - 5.2 mm; plain; snap-on type; gray	www.wago.com/2009-115/000-007
	Item no.: 2009-115/000-012 WMB-Inline; for Smart Printer; 1500 pieces on roll; stretchable 5 - 5.2 mm; plain; snap-on type; white	www.wago.com/2009-115/000-012
	Item no.: 2009-115/000-017 WMB-Inline; for Smart Printer; 1500 pieces on roll; stretchable 5 - 5.2 mm; plain; snap-on type; white	www.wago.com/2009-115/000-017
	Item no.: 2009-115/000-023 WMB-Inline; for Smart Printer; 1500 pieces on roll; stretchable 5 - 5.2 mm; plain; snap-on type; green	www.wago.com/2009-115/000-023
	Item no.: 2009-115/000-024 WMB-Inline; for Smart Printer; 1500 pieces on roll; stretchable 5 - 5.2 mm; plain; snap-on type; white	www.wago.com/2009-115/000-024
	Item no.: 793-501 WMB marking card; as card; not stretchable; plain; snap-on type; white	www.wago.com/793-501
	Item no.: 793-501/000-002 WMB marking card; as card; not stretchable; plain; snap-on type; yellow	www.wago.com/793-501/000-002
	Item no.: 793-501/000-005 WMB marking card; as card; not stretchable; plain; snap-on type; red	www.wago.com/793-501/000-005

Subject to changes. Please also observe the further product documentation!



Item no.: 793-501/000-006
WMB marking card; as card; not stretchable; plain; snap-on type; blue

www.wago.com/793-501/000-006



Item no.: 793-501/000-007
WMB marking card; as card; not stretchable; plain; snap-on type; gray

www.wago.com/793-501/000-007



Item no.: 793-501/000-012
WMB marking card; as card; not stretchable; plain; snap-on type; orange

www.wago.com/793-501/000-012



Item no.: 793-501/000-017
WMB marking card; as card; not stretchable; plain; snap-on type; light green

www.wago.com/793-501/000-017



Item no.: 793-501/000-023
WMB marking card; as card; not stretchable; plain; snap-on type; green

www.wago.com/793-501/000-023



Item no.: 793-501/000-024
WMB marking card; as card; not stretchable; plain; snap-on type; violet

www.wago.com/793-501/000-024



Item no.: 793-5501
WMB marking card; as card; for terminal block width 5 - 17.5 mm; stretchable 5 - 5.2 mm; plain; snap-on type; white

www.wago.com/793-5501



Item no.: 793-5501/000-002
WMB marking card; as card; for terminal block width 5 - 17.5 mm; stretchable 5 - 5.2 mm; plain; snap-on type; yellow

www.wago.com/793-5501/000-002



Item no.: 793-5501/000-005
WMB marking card; as card; for terminal block width 5 - 17.5 mm; stretchable 5 - 5.2 mm; plain; snap-on type; red

www.wago.com/793-5501/000-005



Item no.: 793-5501/000-006
WMB marking card; as card; for terminal block width 5 - 17.5 mm; stretchable 5 - 5.2 mm; plain; snap-on type; blue

www.wago.com/793-5501/000-006

Item no.: 793-5501/000-007
WMB marking card; as card; for terminal block width 5 - 17.5 mm; stretchable 5 - 5.2 mm; plain; snap-on type; gray

www.wago.com/793-5501/000-007



Item no.: 793-5501/000-012
WMB marking card; as card; for terminal block width 5 - 17.5 mm; stretchable 5 - 5.2 mm; plain; snap-on type; orange

www.wago.com/793-5501/000-012

Item no.: 793-5501/000-014
WMB marking card; as card; for terminal block width 5 - 17.5 mm; stretchable 5 - 5.2 mm; plain; snap-on type; brown

www.wago.com/793-5501/000-014

Subject to changes. Please also observe the further product documentation!

**Item no.: 793-5501/000-017**

WMB marking card; as card; for terminal block width 5 - 17.5 mm; stretchable 5 - 5.2 mm; plain; snap-on type; green www.wago.com/793-5501/000-017

**Item no.: 793-5501/000-023**

WMB marking card; as card; for terminal block width 5 - 17.5 mm; stretchable 5 - 5.2 mm; plain; snap-on type; light green www.wago.com/793-5501/000-023

**Item no.: 793-5501/000-024**

WMB marking card; as card; for terminal block width 5 - 17.5 mm; stretchable 5 - 5.2 mm; plain; snap-on type; violet www.wago.com/793-5501/000-024

Terminal Block**Item no.: 2002-1661**

2-conductor carrier terminal block; for DIN-rail 35 x 15 and 35 x 7.5; 2.5 mm²; Push-in CAGE CLAMP®; 2,50 mm²; gray www.wago.com/2002-1661

**Item no.: 2002-1662**

2-conductor carrier terminal block; for DIN-rail 35 x 15 and 35 x 7.5; 2.5 mm²; Push-in CAGE CLAMP®; 2,50 mm²; orange www.wago.com/2002-1662

**Item no.: 2002-1761**

3-conductor carrier terminal block; for DIN-rail 35 x 15 and 35 x 7.5; 2.5 mm²; Push-in CAGE CLAMP®; 2,50 mm²; gray www.wago.com/2002-1761

**Item no.: 2002-1861**

4-conductor carrier terminal block; for DIN-rail 35 x 15 and 35 x 7.5; 2.5 mm²; Push-in CAGE CLAMP®; 2,50 mm²; gray www.wago.com/2002-1861

**Item no.: 2002-1961**

2-conductor carrier terminal block; with additional jumper position; for DIN-rail 35 x 15 and 35 x 7.5; 2.5 mm²; Push-in CAGE CLAMP®; 2,50 mm²; gray www.wago.com/2002-1961

Item no.: 2002-2941

Double-deck, double-disconnect terminal block; L/L; for DIN-rail 35 x 15 and 35 x 7.5; 2.5 mm²; Push-in CAGE CLAMP®; 2,50 mm²; gray www.wago.com/2002-2941

**Item no.: 2002-2961**

Double-deck carrier terminal block; L/L; for DIN-rail 35 x 15 and 35 x 7.5; 2.5 mm²; Push-in CAGE CLAMP®; 2,50 mm²; gray www.wago.com/2002-2961

**Item no.: 2002-2963**

Double-deck carrier terminal block; L/N; for DIN-rail 35 x 15 and 35 x 7.5; 2.5 mm²; Push-in CAGE CLAMP®; 2,50 mm²; gray www.wago.com/2002-2963

**Item no.: 2003-6640**

Multilevel installation terminal block; 4 mm²; Carrier terminal block without knife; N/L/PE; Push-in CAGE CLAMP®; 2,50 mm²; gray www.wago.com/2003-6640

**Item no.: 2003-6643**

Multilevel installation terminal block; 4 mm²; Carrier terminal block without knife; P2/P1/PE; black upper deck; brown middle deck; green-yellow lower deck; Push-in CAGE CLAMP®; 2,50 mm²; gray www.wago.com/2003-6643

**Item no.: 2003-6660**

Multilevel installation terminal block; 4 mm²; Carrier terminal block without knife; P1/P2/PE; brown upper-deck; black middle-deck; green-yellow lower deck; Push-in CAGE CLAMP®; 2,50 mm²; gray www.wago.com/2003-6660

**Item no.: 2202-1661**

2-conductor carrier terminal block; with push-button; for DIN-rail 35 x 15 and 35 x 7.5; 2.5 mm²; Push-in CAGE CLAMP®; 2,50 mm²; gray www.wago.com/2202-1661

Subject to changes. Please also observe the further product documentation!

WAGO Kontakttechnik GmbH & Co. KG

Hansastr. 27

32423 Minden

Phone: +49571 887-0 | Fax: +49571 887-169

Email: info.de@wago.com | Web: www.wago.com

Do you have any questions about our products?

We are always happy to take your call at +49 (571) 887-44222.



Item no.: 2202-1761

3-conductor carrier terminal block; with push-button; for DIN-rail 35 x 15 and 35 x 7.5; 2.5 mm²; Push-in CAGE CLAMP®; 2,50 mm²; gray www.wago.com/2202-1761



Item no.: 2202-1861

4-conductor carrier terminal block; with push-button; for DIN-rail 35 x 15 and 35 x 7.5; 2.5 mm²; Push-in CAGE CLAMP®; 2,50 mm²; gray www.wago.com/2202-1861



Item no.: 2202-1961

2-conductor carrier terminal block; with push-button; with additional jumper position; for DIN-rail 35 x 15 and 35 x 7.5; 2.5 mm²; Push-in CAGE CLAMP®; 2,50 mm²; gray www.wago.com/2202-1961

General accessories



Item no.: 281-503

Shorting link; 5 x 20 mm; if the fuse plug is used as disconnect plug

www.wago.com/281-503

Downloads

Documentation

Additional Information

Technical explanations

Apr 3, 2019

pdf
2.1 MB

Download

Installation Notes

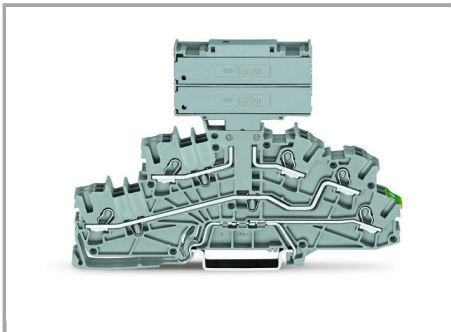

Double-fuse plugs with (5 x 25) mm miniature metric fuses can be used on carrier terminal blocks without N-knife disconnect in standard terminal block width.

Subject to changes. Please also observe the further product documentation!

Glass cartridge fuses 5 x 20				
Series Item No.	Overload and short circuit protection		Short circuit protection only	
	Individual argmt.	Group argmt.	Individual argmt.	Group argmt.
Fuse terminal blocks				
2003-911				
2003-911/.....	1.6 W	1.6 W	2.5 W	2.5 W

When selecting miniature metric fuses, make sure that the maximum power loss listed above is not exceeded. The power loss is determined according to IEC or EN 60947-7-3/VDE 0611-6 at 23 °C. The temperature rise of the terminal blocks must be checked according to their application and mounting. Higher ambient temperatures place additional strain on fuse cartridges. Therefore, in such applications, the rated current must be reduced if necessary. More details are available from the fuse manufacturers.

Product family

TOPJOB® S

TOPJOB® S: In various industrial applications and modern building installations, WAGO's wide and versatile range of rail-mount terminal blocks provides more than just reliable electrical connections.

[Learn more about the product family.](#)

[Show all products from the family](#)

Subject to changes. Please also observe the further product documentation!