

Data sheet | Item number: 2001-1406

4-conductor through terminal block; 1.5 mm²; suitable for Ex e II applications; side and center marking; for DIN-rail 35 x 15 and 35 x 7.5; Push-in CAGE CLAMP®; 1,50 mm²; yellow

www.wago.com/2001-1406

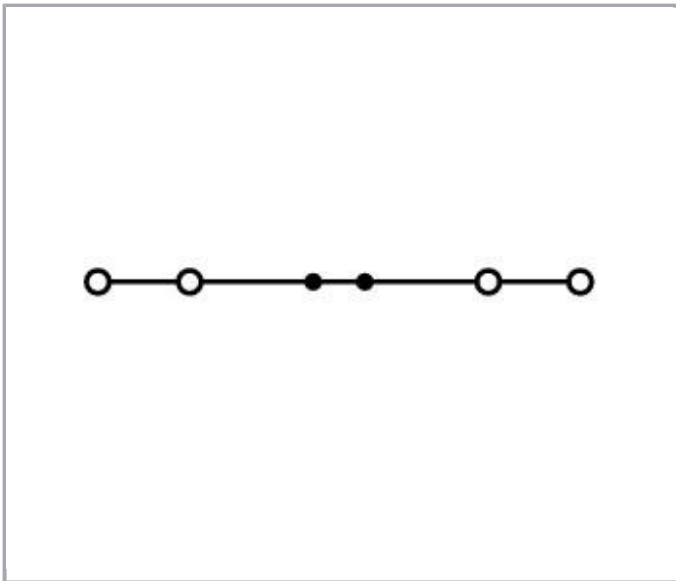
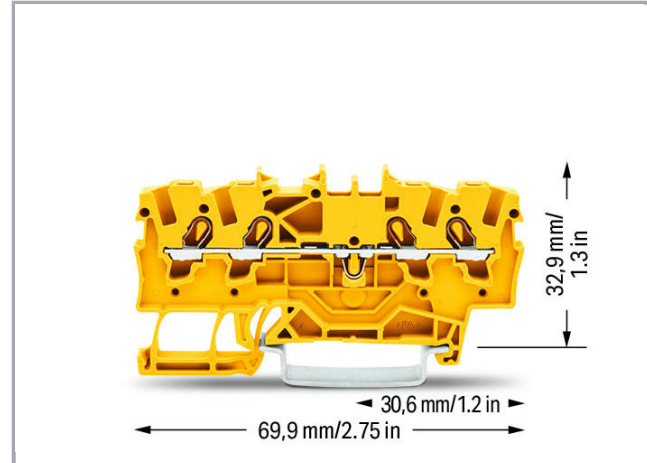
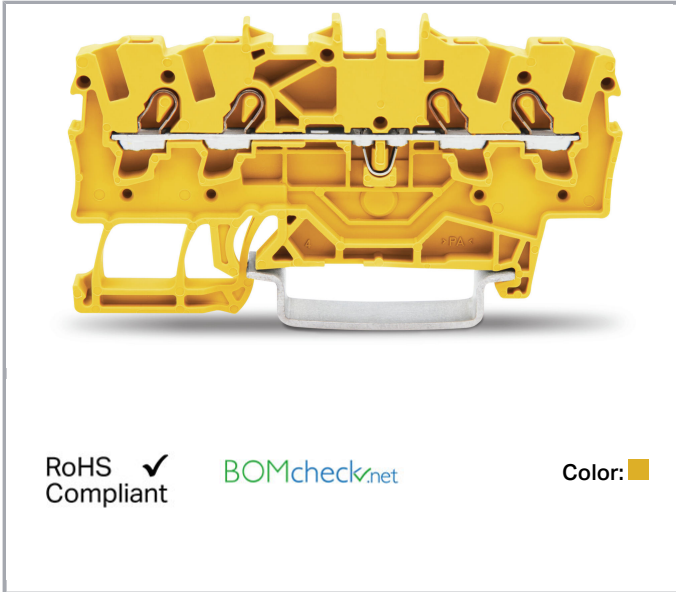

Data

Electrical data

Subject to changes. Please also observe the further product documentation!

WAGO Kontakttechnik GmbH & Co. KG
Hansastr. 27
32423 Minden
Phone: +49571 887-0 | Fax: +49571 887-169
Email: info.de@wago.com | Web: www.wago.com

Do you have any questions about our products?
We are always happy to take your call at +49 (571) 887-44222.



Ratings per IEC/EN 60664-1

Ratings per	IEC/EN 60947-7-1
Rated voltage (III / 3)	800 V
Rated impulse voltage (III / 3)	8 kV
Rated current	18 A
Rated current (2)	24 A
Legend (ratings)	(III / 3) $\hat{=}$ Overvoltage category III / Pollution degree 3

Approvals per UL 1059

Rated voltage UL (Use Group B)	600 V
Rated current UL (Use Group B)	15 A
Rated voltage UL (Use Group C)	600 V
Rated current UL (Use Group C)	15 A
Approvals per	UL 1059

Approvals per CSA

Rated voltage CSA (Use Group B)	600 V
Rated current CSA (Use Group B)	15 A
Rated voltage CSA (Use Group C)	600 V
Rated current CSA (Use Group C)	15 A

Approvals Ex

Rated voltage EN (Ex e II)	550 V
Rated current (Ex e II)	17 A
Rated current (Ex e II) with jumper	16 A

Connection data

Connection technology	Push-in CAGE CLAMP®
Actuation type	Push-in Open Tool Slot
Connectable conductor materials	Copper
Nominal cross section	1,5 mm ²
Solid conductor	0,25 ... 2,5 mm ² / 22 ... 14 AWG
Solid conductor, push-in termination	0,75 ... 2,5 mm ² / 18 ... 14 AWG
Fine-stranded conductor	0,25 ... 2,5 mm ² / 22 ... 14 AWG

Subject to changes. Please also observe the further product documentation!



Fine-stranded conductor with ferrule with plastic collar	0,75 ... 1,5 mm ² / 18 ... 16 AWG
Fine-stranded conductor with ferrule, push-in termination, from	0,75 ... 1,5 mm ² / 18 ... 16 AWG
Strip length	9 ... 11 mm / 0.35 ... 0.43 inch
Total number of connection points	4
Total number of potentials	1
Number of levels	1
Type of wiring	Front-entry wiring
Note (conductor cross-section)	Depending on the conductor characteristic, a conductor with a smaller cross section can also be inserted via push-in termination.
Number of jumper slots	2

Geometrical Data

Width	4,2 mm / 0.165 inch
Height from upper-edge of DIN-35 rail	32,9 mm / 1.295 inch
Depth	69,9 mm / 2.752 inch

Mechanical data

Design	horizontal
Type of mounting	DIN-35 rail
Marking level	Center/side marking

Material Data

Color	yellow
Insulating material	Polyamide 66 (PA 66)
Fire load	0.104 MJ
Weight	5.8 g

Commercial data

Product Group	22 (TOPJOB S)
Packaging type	BOX
Country of origin	DE
GTIN	4045454537432
Customs Tariff No.	85369010000

Approvals / Certificates



Ex-Approvals

Certificate



Subject to changes. Please also observe the further product documentation!

WAGO Kontakttechnik GmbH & Co. KG
 Hansastr. 27
 32423 Minden
 Phone: +49571 887-0 | Fax: +49571 887-169
 Email: info.de@wago.com | Web: www.wago.com



Do you have any questions about our products?
 We are always happy to take your call at +49 (571) 887-44222.

Logo	Approval	Additional Approval Text	name
	ATEX Physikalisch Technische Bundesanstalt (PTB)	EN 60079	PTB 05 ATEX 1094 U (II 2 G Ex e II bzw. I M 2 Ex e I)
	IECEX Physikalisch Technische Bundesanstalt (PTB)	IEC 60079	IECEX PTB 11.0093U (Ex e IIC Gb or Ex e I Mb)

Country specific Approvals

Logo	Approval	Additional Approval Text	Certificate name
	CCA DEKRA Certification B.V.	EN 60947	2160584.07
	CCA DEKRA Certification B.V.	EN 60947	NTR NL- 7084
	CSA DEKRA Certification B.V.	C22.2 No. 158	1645434

Ship Approvals

Logo	Approval	Additional Approval Text	Certificate name
	ABS American Bureau of Shipping	EN 60947	20- HG1941090- PDA
	DNV GL Det Norske Veritas, Germanischer Lloyd	-	TAE00001V2
	LR Lloyds Register	EN 60947	91/20112 (E9)

Subject to changes. Please also observe the further product documentation!



UL-Approvals

Logo	Approval	Additional Approval Text	Certificate name
	UL UL International Germany GmbH	UL 1059	20190731- E45172





Counterpart

Compatible products













Push-In type wire jumper

	Item no.: 2009-412 Push-in type wire jumper; insulated; wire length 60 mm; Conductor cross section 1.5 mm ² ; suitable for 2001, 2002, 2003 and 2022 Series rail-mounted terminal blocks; black	www.wago.com/2009-412
	Item no.: 2009-414 Push-in type wire jumper; insulated; wire length 110 mm; Conductor cross section 1.5 mm ² ; suitable for 2001, 2002, 2003 and 2022 Series rail-mounted terminal blocks; black	www.wago.com/2009-414
	Item no.: 2009-416 Push-in type wire jumper; insulated; wire length 250 mm; Conductor cross section 1.5 mm ² ; suitable for 2001, 2002, 2003 and 2022 Series rail-mounted terminal blocks; black	www.wago.com/2009-416

Test Accessories

	Item no.: 2001-511 Modular TOPJOB®S connector; modular; for jumper contact slot; 1-pole; 1,50 mm ² ; gray	www.wago.com/2001-511
	Item no.: 2001-549 Spacer module; modular; e.g., for bridging commoned terminal blocks; gray	www.wago.com/2001-549
	Item no.: 2001-552 Modular TOPJOB®S connector; modular; for jumper contact slot; 2-pole; 1,50 mm ² ; gray	www.wago.com/2001-552
	Item no.: 2001-553 Modular TOPJOB®S connector; modular; for jumper contact slot; 3-pole; 1,50 mm ² ; gray	www.wago.com/2001-553

Subject to changes. Please also observe the further product documentation!

	Item no.: 2001-554 Modular TOPJOB®S connector; modular; for jumper contact slot; 4-pole; 1,50 mm ² ; gray	www.wago.com/2001-554
	Item no.: 2001-555 Modular TOPJOB®S connector; modular; for jumper contact slot; 5-pole; 1,50 mm ² ; gray	www.wago.com/2001-555
	Item no.: 2001-556 Modular TOPJOB®S connector; modular; for jumper contact slot; 6-pole; 1,50 mm ² ; gray	www.wago.com/2001-556
	Item no.: 2001-557 Modular TOPJOB®S connector; modular; for jumper contact slot; 7-pole; 1,50 mm ² ; gray	www.wago.com/2001-557
	Item no.: 2001-558 Modular TOPJOB®S connector; modular; for jumper contact slot; 8-pole; 1,50 mm ² ; gray	www.wago.com/2001-558
	Item no.: 2001-559 Modular TOPJOB®S connector; modular; for jumper contact slot; 9-pole; 1,50 mm ² ; gray	www.wago.com/2001-559
	Item no.: 2001-560 Modular TOPJOB®S connector; modular; for jumper contact slot; 10-pole; 1,50 mm ² ; gray	www.wago.com/2001-560
	Item no.: 2009-174 Test plug adapter; for 4 mm Ø test plugs; for testing TOPJOB®S rail-mounted terminal blocks; gray	www.wago.com/2009-174
	Item no.: 2009-182 Testing tap; for max. 2.5 mm ² ; tool-free connection for individual test wires 0.08 - 2.5 mm; gray	www.wago.com/2009-182
tools		
	Item no.: 210-647 Operating tool; Blade: 2.5 x 0.4 mm; with a partially insulated shaft	www.wago.com/210-647
	Item no.: 210-648 Operating tool; Blade: 2.5 x 0.4 mm; with a partially insulated shaft; angled; short	www.wago.com/210-648
	Item no.: 210-719 Operating tool; Blade: 2.5 x 0.4 mm; with a partially insulated shaft	www.wago.com/210-719
Insulation stop		
	Item no.: 2001-171 Insulation stop; 0.25 - 0.5 mm ² ; 5 pieces/strip; light gray	www.wago.com/2001-171
ferrule		
	Item no.: 216-241 Ferrule; Sleeve for 0.5 mm ² / 20 AWG; insulated; electro-tin plated; electrolytic copper; gastight crimped; acc. to DIN 46228, Part 4/09.90; white	www.wago.com/216-241
	Item no.: 216-242 Ferrule; Sleeve for 0.75 mm ² / 18 AWG; insulated; electro-tin plated; electrolytic copper; gastight crimped; acc. to DIN 46228, Part 4/09.90; gray	www.wago.com/216-242
	Item no.: 216-243 Ferrule; Sleeve for 1 mm ² / AWG 18; insulated; electro-tin plated; electrolytic copper; gastight crimped; acc. to DIN 46228, Part 4/09.90; red	www.wago.com/216-243
	Item no.: 216-244	

Subject to changes. Please also observe the further product documentation!

Ferrule; Sleeve for 1.5 mm² / AWG 16; insulated; electro-tin plated; electrolytic copper; gastight crimped; acc. to DIN 46228, Part 4/09.90; black

www.wago.com/216-244

Protective Warning Marker



Item no.: 2001-115

Protective warning marker; with high-voltage symbol, black; for 5 terminal blocks; yellow

www.wago.com/2001-115

Marking accessories

Item no.: 2009-110

Marking strips; on reel; not stretchable; plain; snap-on type; white

www.wago.com/2009-110

Item no.: 2009-114

WMB-Inline; for Smart Printer; 2000 pieces on roll; stretchable 4 - 4.2 mm; plain; snap-on type; white

www.wago.com/2009-114



Item no.: 2009-114/000-002

WMB-Inline; for Smart Printer; 2000 pieces on roll; stretchable 4 - 4.2 mm; plain; snap-on type; yellow

www.wago.com/2009-114/000-002



Item no.: 2009-114/000-005

WMB-Inline; for Smart Printer; 2000 pieces on roll; stretchable 4 - 4.2 mm; plain; snap-on type; red

www.wago.com/2009-114/000-005

Item no.: 2009-114/000-006

WMB-Inline; for Smart Printer; 2000 pieces on roll; stretchable 4 - 4.2 mm; plain; snap-on type; blue

www.wago.com/2009-114/000-006



Item no.: 2009-114/000-007

WMB-Inline; for Smart Printer; 2000 pieces on roll; stretchable 4 - 4.2 mm; plain; snap-on type; gray

www.wago.com/2009-114/000-007



Item no.: 2009-114/000-012

WMB-Inline; for Smart Printer; 2000 pieces on roll; stretchable 4 - 4.2 mm; plain; snap-on type; orange

www.wago.com/2009-114/000-012



Item no.: 2009-114/000-023

WMB-Inline; for Smart Printer; 2000 pieces on roll; stretchable 4 - 4.2 mm; plain; snap-on type; green

www.wago.com/2009-114/000-023



Item no.: 2009-114/000-024

WMB-Inline; for Smart Printer; 2000 pieces on roll; stretchable 4 - 4.2 mm; plain; snap-on type; violet

www.wago.com/2009-114/000-024



Item no.: 793-4501

WMB marking card; as card; stretchable 4 - 4.2 mm; plain; snap-on type; white

www.wago.com/793-4501

Item no.: 793-4501/000-002

WMB marking card; as card; stretchable 4 - 4.2 mm; plain; snap-on type; yellow

www.wago.com/793-4501/000-002

Item no.: 793-4501/000-005

WMB marking card; as card; stretchable 4 - 4.2 mm; plain; snap-on type; red

www.wago.com/793-4501/000-005

Subject to changes. Please also observe the further product documentation!

WAGO Kontakttechnik GmbH & Co. KG

Hansastr. 27

32423 Minden

Phone: +49571 887-0 | Fax: +49571 887-169

Email: info.de@wago.com | Web: www.wago.com

Do you have any questions about our products?

We are always happy to take your call at +49 (571) 887-44222.



Item no.: 793-4501/000-006
WMB marking card; as card; stretchable 4 - 4.2 mm; plain; snap-on type; blue

www.wago.com/793-4501/000-006



Item no.: 793-4501/000-007
WMB marking card; as card; stretchable 4 - 4.2 mm; plain; snap-on type; gray

www.wago.com/793-4501/000-007



Item no.: 793-4501/000-012
WMB marking card; as card; stretchable 4 - 4.2 mm; plain; snap-on type; orange

www.wago.com/793-4501/000-012



Item no.: 793-4501/000-017
WMB marking card; as card; stretchable 4 - 4.2 mm; plain; snap-on type; green

www.wago.com/793-4501/000-017



Item no.: 793-4501/000-023
WMB marking card; as card; stretchable 4 - 4.2 mm; plain; snap-on type; light green

www.wago.com/793-4501/000-023



Item no.: 793-4501/000-024
WMB marking card; as card; stretchable 4 - 4.2 mm; plain; snap-on type; violet

www.wago.com/793-4501/000-024



Item no.: 793-501
WMB marking card; as card; not stretchable; plain; snap-on type; white

www.wago.com/793-501



Item no.: 793-501/000-002
WMB marking card; as card; not stretchable; plain; snap-on type; yellow

www.wago.com/793-501/000-002



Item no.: 793-501/000-005
WMB marking card; as card; not stretchable; plain; snap-on type; red

www.wago.com/793-501/000-005

Item no.: 793-501/000-006
WMB marking card; as card; not stretchable; plain; snap-on type; blue

www.wago.com/793-501/000-006



Item no.: 793-501/000-007
WMB marking card; as card; not stretchable; plain; snap-on type; gray

www.wago.com/793-501/000-007



Item no.: 793-501/000-012
WMB marking card; as card; not stretchable; plain; snap-on type; orange

www.wago.com/793-501/000-012



Item no.: 793-501/000-017
WMB marking card; as card; not stretchable; plain; snap-on type; light green

www.wago.com/793-501/000-017



Item no.: 793-501/000-023
WMB marking card; as card; not stretchable; plain; snap-on type; green

www.wago.com/793-501/000-023

Subject to changes. Please also observe the further product documentation!



Item no.: 793-501/000-024
WMB marking card; as card; not stretchable; plain; snap-on type; violet

www.wago.com/793-501/000-024

Carrier rail

Item no.: 210-112

Steel carrier rail; 35 x 7.5 mm; 1 mm thick; 2 m long; slotted; according to EN 60715; "Hole width 25 mm

www.wago.com/210-112

Item no.: 210-113

Steel carrier rail; 35 x 7.5 mm; 1 mm thick; 2 m long; unslotted; according to EN 60715

www.wago.com/210-113

Item no.: 210-114

Steel carrier rail; 35 x 15 mm; 1.5 mm thick; 2 m long; unslotted; similar to EN 60715

www.wago.com/210-114



Item no.: 210-115

Steel carrier rail; 35 x 7.5 mm; 1 mm thick; 2 m long; slotted; according to EN 60715; "Hole width 18 mm

www.wago.com/210-115



Item no.: 210-118

Steel carrier rail; 35 x 15 mm; 2.3 mm thick; 2 m long; unslotted; according to EN 60715

www.wago.com/210-118

Item no.: 210-196

Aluminum carrier rail; 35 x 8.2 mm; 1.6 mm thick; 2 m long; unslotted; similar to EN 60715; silver-colored

www.wago.com/210-196



Item no.: 210-197

Steel carrier rail; 35 x 15 mm; 1.5 mm thick; 2 m long; slotted; similar to EN 60715

www.wago.com/210-197

Item no.: 210-198

Copper carrier rail; 35 x 15 mm; 2.3 mm thick; 2 m long; unslotted; according to EN 60715; copper-colored

www.wago.com/210-198

End plate



Item no.: 2002-1491

End and intermediate plate; 0.8 mm thick; gray

www.wago.com/2002-1491



Item no.: 2002-1492

End and intermediate plate; 0.8 mm thick; orange

www.wago.com/2002-1492



Item no.: 2002-1493

Separator plate; 2 mm thick; oversized; gray

www.wago.com/2002-1493



Item no.: 2002-1494

Separator plate; 2 mm thick; oversized; orange

www.wago.com/2002-1494



Item no.: 209-191

Separator for Ex e/Ex i applications; 3 mm thick; 120 mm wide; orange

www.wago.com/209-191

Jumper



Item no.: 2001-402

Push-in type jumper bar; insulated; 2-way; Nominal current 18 A; light gray

www.wago.com/2001-402



Item no.: 2001-403

Push-in type jumper bar; insulated; 3-way; Nominal current 18 A; light gray

www.wago.com/2001-403

Subject to changes. Please also observe the further product documentation!

WAGO Kontakttechnik GmbH & Co. KG

Hansastr. 27

















32423 Minden

Phone: +49571 887-0 | Fax: +49571 887-169

Email: info.de@wago.com | Web: www.wago.com

Do you have any questions about our products?

We are always happy to take your call at +49 (571) 887-44222.

	Item no.: 2001-404 Push-in type jumper bar; insulated; 4-way; Nominal current 18 A; light gray	www.wago.com/2001-404
	Item no.: 2001-405 Push-in type jumper bar; insulated; 5-way; Nominal current 18 A; light gray	www.wago.com/2001-405
	Item no.: 2001-405/011-000 Star point jumper; insulated; 3-way (1-3-5); IN = IN terminal block; light gray	www.wago.com/2001-405/011-000
	Item no.: 2001-406 Push-in type jumper bar; insulated; 6-way; Nominal current 18 A; light gray	www.wago.com/2001-406
	Item no.: 2001-406/020-000 Delta jumper; insulated; 1-2 3-4 5-6; IN = IN terminal block; light gray	www.wago.com/2001-406/020-000
	Item no.: 2001-407 Push-in type jumper bar; insulated; 7-way; Nominal current 18 A; light gray	www.wago.com/2001-407
	Item no.: 2001-408 Push-in type jumper bar; insulated; 8-way; Nominal current 18 A; light gray	www.wago.com/2001-408
	Item no.: 2001-409 Push-in type jumper bar; insulated; 9-way; Nominal current 18 A; light gray	www.wago.com/2001-409
	Item no.: 2001-410 Push-in type jumper bar; insulated; 10-way; Nominal current 18 A; light gray	www.wago.com/2001-410
	Item no.: 2001-433 Push-in type jumper bar; insulated; from 1 to 3; Nominal current 18 A; light gray	www.wago.com/2001-433
	Item no.: 2001-434 Push-in type jumper bar; insulated; from 1 to 4; Nominal current 18 A; light gray	www.wago.com/2001-434
	Item no.: 2001-435 Push-in type jumper bar; insulated; from 1 to 5; Nominal current 18 A; light gray	www.wago.com/2001-435
	Item no.: 2001-436 Push-in type jumper bar; insulated; from 1 to 6; Nominal current 18 A; light gray	www.wago.com/2001-436
	Item no.: 2001-437 Push-in type jumper bar; insulated; from 1 to 7; Nominal current 18 A; light gray	www.wago.com/2001-437
	Item no.: 2001-438 Push-in type jumper bar; insulated; from 1 to 8; Nominal current 18 A; light gray	www.wago.com/2001-438
	Item no.: 2001-439 Push-in type jumper bar; insulated; from 1 to 9; Nominal current 18 A; light gray	www.wago.com/2001-439
	Item no.: 2001-440 Push-in type jumper bar; insulated; from 1 to 10; Nominal current 18 A; light gray	www.wago.com/2001-440
	Item no.: 2006-499	

Subject to changes. Please also observe the further product documentation!



Step-down jumper; insulated; from 6/4 mm² to 4/2.5/1.5 mm²; Nominal current 32 A; light gray

www.wago.com/2006-499



Item no.: 210-103

Wire commoning chain; insulated; 50 connections; black

www.wago.com/210-103



Item no.: 210-123

Wire commoning chain; insulated; 50 connections

www.wago.com/210-123

Downloads

Documentation

Additional Information

Technical explanations	Apr 3, 2019	pdf 2.1 MB	Download
------------------------	-------------	---------------	----------

CAD/CAE-Data

CAD data

2D/3D Models 2001-1406	URL	Download
------------------------	-----	----------

CAE data

EPLAN Data Portal 2001-1406	URL	Download
-----------------------------	-----	----------

WSCAD Universe 2001-1406	URL	Download
--------------------------	-----	----------

Installation Notes

Inserting a conductor

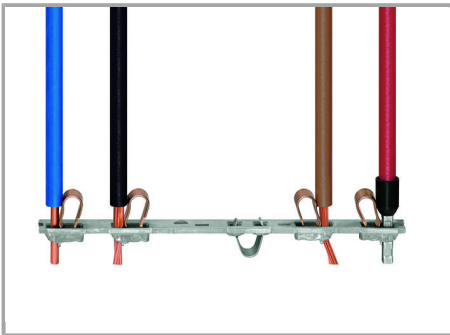

All conductor types at a glance

Subject to changes. Please also observe the further product documentation!

WAGO Kontakttechnik GmbH & Co. KG
Hansastr. 27
32423 Minden
Phone: +49571 887-0 | Fax: +49571 887-169
Email: info.de@wago.com | Web: www.wago.com

Do you have any questions about our products?
We are always happy to take your call at +49 (571) 887-44222.

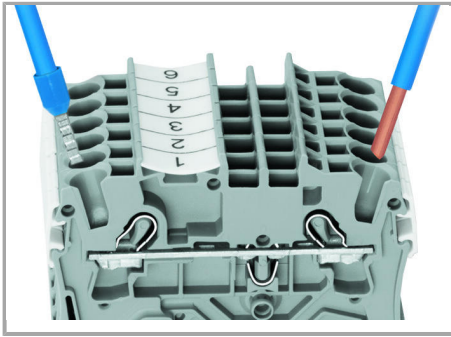

Terminating solid and ferruled conductors via push-in connection.

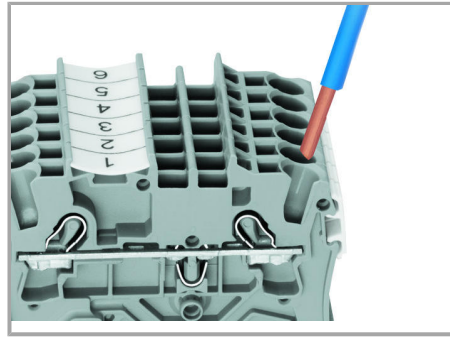

Inserting conductors via push-in termination.

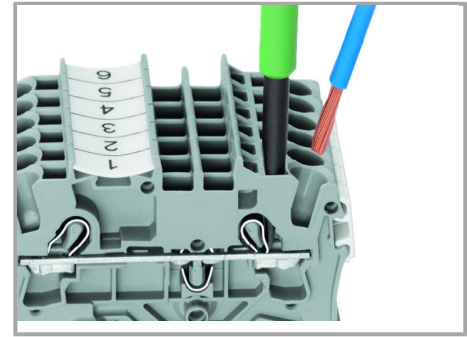

Inserting a conductor via operating tool.

Solid conductors with cross-sections from either one size above, or up to two sizes below, the rated cross-section can be simply pushed in – no tools needed.

Connecting fine-stranded conductors without ferrules, or small cross-sectional conductors that cannot be pushed in, is performed similarly to the original CAGE CLAMP® – just use an operating tool.

The smart feature:

To open the clamp, the operating tool is inserted vertically. The conductor entry is less than 15 degrees for easier wiring.

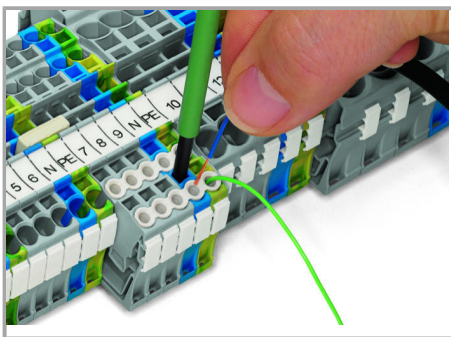

Conductor termination – Insulation stop.

Commoning

Subject to changes. Please also observe the further product documentation!



The push-in type jumper bar system is based on the common plug and socket principle. Each terminal block is spring-loaded with a double socket and a resilient CrNi steel spring. The jumper contact material is pure electrolytic copper, which allows for an extremely small design capable of carrying the full-rated current of the terminal block. Ground terminal blocks can also be commoned using the same jumper system. Custom jumpers are created by breaking and removing jumper contacts (2000, 2001, 2002, 2004 Series).

Removing a push-in type jumper bar.

Insert the operating tool between the jumper and the partition wall of the dual jumper slots, then lift up the jumper.

Place the operating tool in the center of jumpers up to five contacts (see above), or alternately on both sides for jumpers with more than five contacts.

Commoning

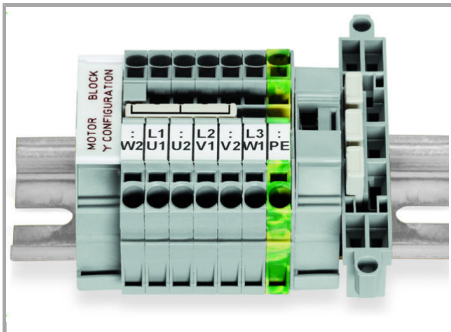

This star point jumper has been specially developed to create a "star point" and is used on motor terminal boards equipped with TOPJOB® S rail-mount terminal blocks.

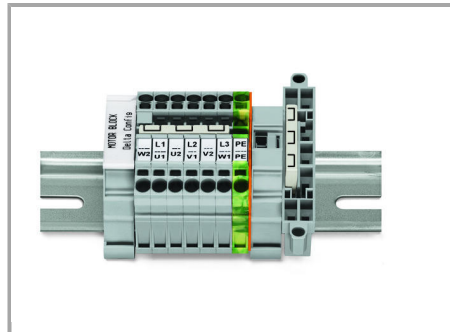

This delta jumper has been specially developed to create a delta configuration and is used on motor terminal boards equipped with TOPJOB® S rail-mount terminal blocks.

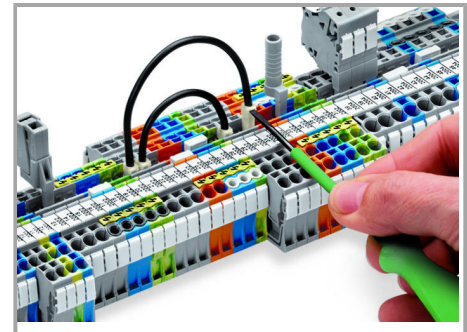

Push down the wire jumper until fully inserted. Lift the jumper with an operating tool for rewiring.

Commoning

Subject to changes. Please also observe the further product documentation!

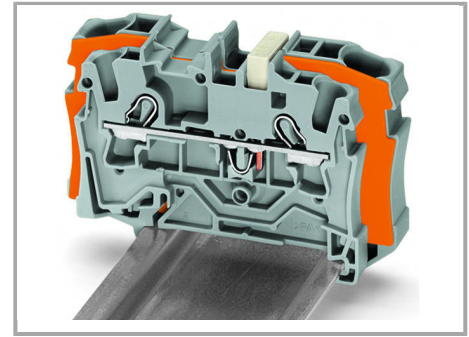
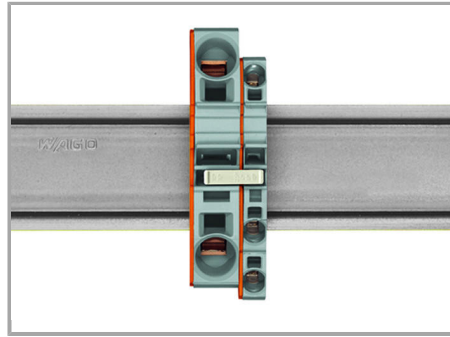
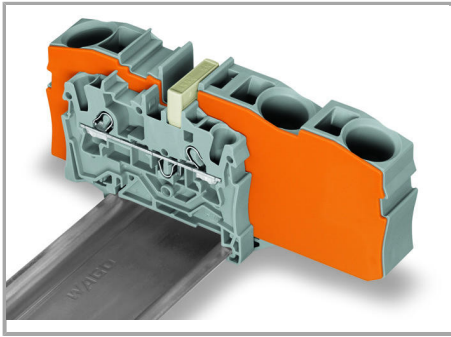

Step-down jumpers may common terminal blocks of different sizes, without losing a conductor clamping point. This can be beneficial on long conductor runs where voltage drops may be problematic. A large conductor can be easily connected to smaller conductors at the distribution point.

Using step-down jumpers, an end plate must be inserted between the terminal blocks to be commoned.

Step-down jumper (2006-499) commons 6 /4 mm² (10/12 AWG) terminal blocks (2006 /2004 Series) with 4/2.5/1.5 mm² (12/14/16 AWG) terminal blocks (2004/2002/2001 Series).

Commoning may be made in either direction using the special thin end plate to cover the open side. Additional through terminal blocks having a smaller cross-section may be commoned using push-in type jumper bars.

Subject to changes. Please also observe the further product documentation!

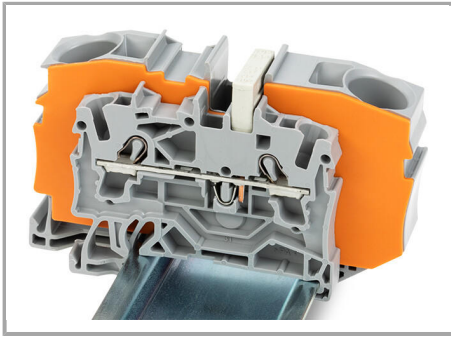

Step-down jumper (2016-499) commons 16 /10 mm² (16/8 AWG) terminal blocks (2016 /2010 Series) with 10/6/4/2.5 mm² (8/10/12 /14 AWG) terminal blocks (2010/2006/2004 /2002 Series).

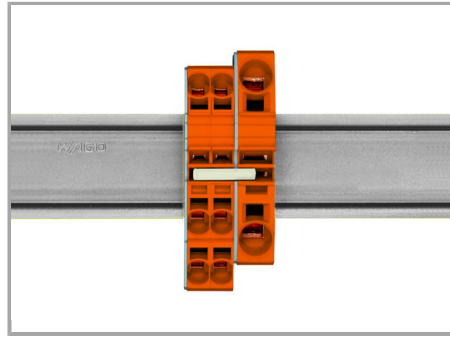

Stepping down via push-in type jumper bar.

Commoning via open terminal side with end plate allows jumpering over two cross-section sizes for 16 mm² (6 AWG) and 10 mm² (8 AWG) and one cross-section size for 6/4/2.5 mm² (10/12/14 AWG). An example: from 16 mm² (6 AWG) to 6 mm² (10 AWG) (see illustration above) or from 10 mm² (8 AWG) to 4 mm² (12 AWG).

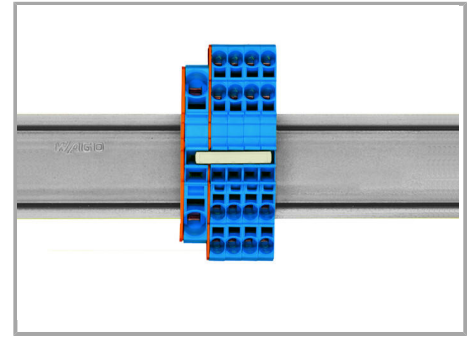

Stepping down via push-in type jumper bar.

Commoning via closed terminal side with end plate allows jumpering over two cross-section sizes, e.g., from 16 mm² (6 AWG) to 6 mm² (10 AWG) or from 6 mm² (10 AWG) to 2.5 mm² (14 AWG) (see illustration above).

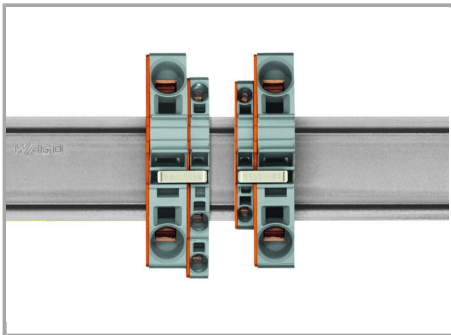

Note:

The total current of the outgoing circuits shall not exceed the nominal current of the step-down jumper/push-in type jumper bar.

Testing

Subject to changes. Please also observe the further product documentation!

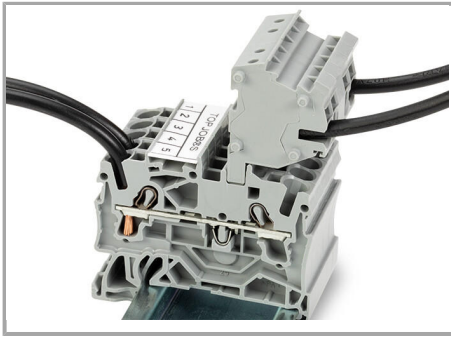

The modular TOPJOB® S connectors also connect conductors of the same size as the terminal blocks being used.

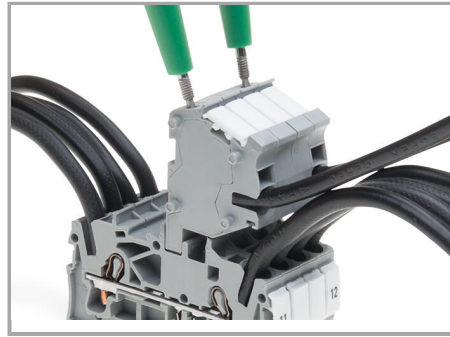

TOPJOB® S Connectors with a 2 mm Ø test socket for testing voltage via 2-pole voltage tester

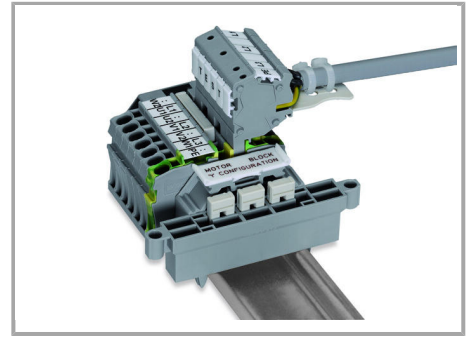

Rail-mount terminal block assembly for electric motor wiring

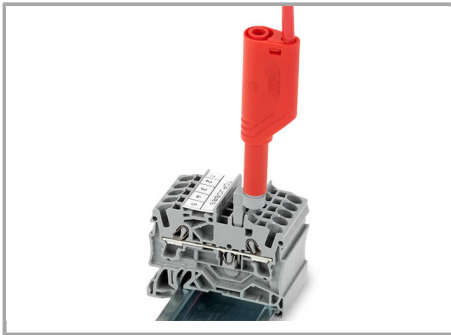

Test plug adapter (2009-174, CAT II) for 4 mm Ø plugs – compatible with 2000 to 2016 Series

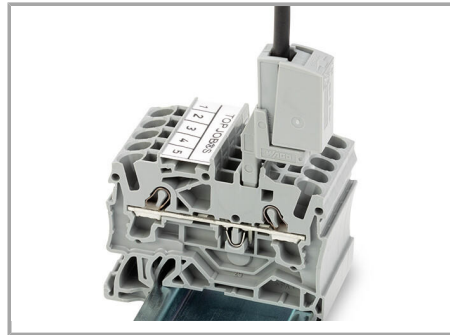

Testing tap (2009-182) for tool-free connection of test cables up to 2.5 mm² (12 AWG) – compatible with 2000 to 2016 Series

Marking

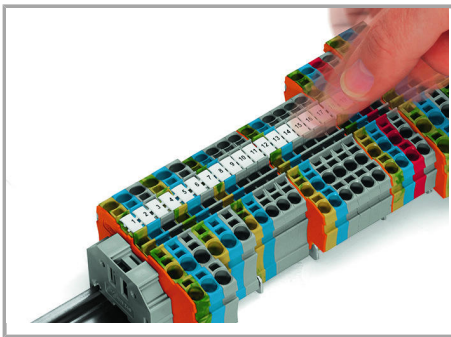

Snapping WMB Inline markers into marker slots.

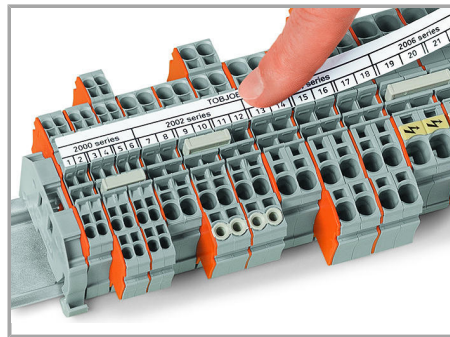

Subject to changes. Please also observe the further product documentation!

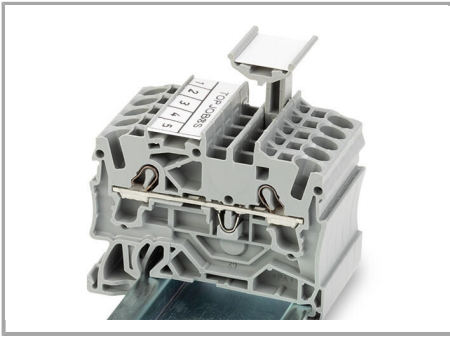

TOPJOB® S 2009-193 Group Marker Carrier (equipped with a marking strip) for all 2001 to 2016 Series TOPJOB® S Rail-Mount Terminal Blocks

Do not use on an end plate!

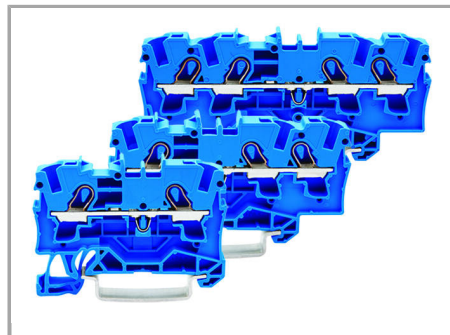
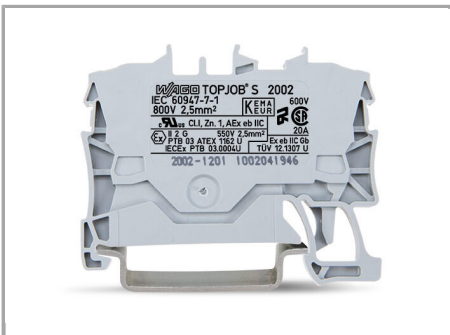

Through terminal blocks with a blue insulated housing are suitable for Ex i applications.



All through and ground conductor terminal blocks are suitable for Ex e II applications.

Subject to changes. Please also observe the further product documentation!

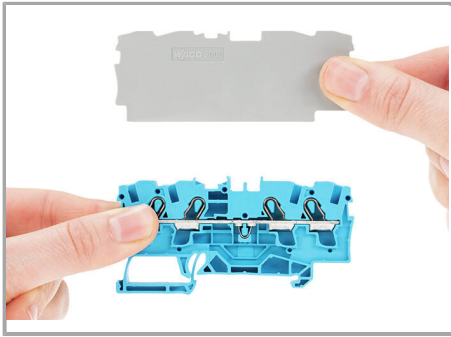

Separator for Ex e/Ex applications

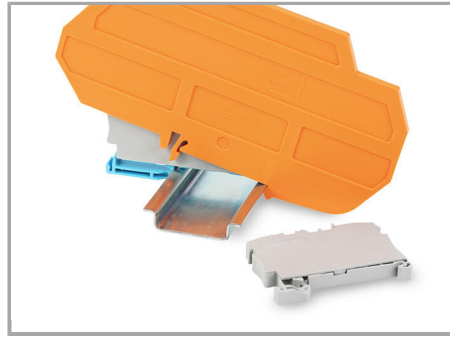

Ex e II/Ex i terminal strip

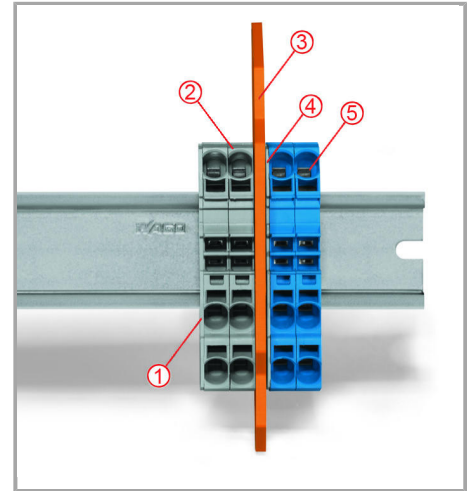

Separator located between Ex e II and Ex i terminal strip

An end plate must be applied to the terminal block located directly behind an Ex e/Ex i separator plate.

Notice:

The movable feet of terminal blocks and separator plates must face the same direction.

End plate

Ex e II terminal blocks

Separator for Ex e/Ex i applications

End plate

Ex i terminal blocks

According to EN 50020, a minimum distance of 50 mm must be kept between live parts of Ex e and Ex i circuits. The use of Ex e/Ex i separators is a space-saving solution when Ex e and Ex i terminal blocks are mounted on a common carrier rail.

Product family

TOPJOB® S

Subject to changes. Please also observe the further product documentation!



TOPJOB® S: In various industrial applications and modern building installations, WAGO's wide and versatile range of rail-mount terminal blocks provides more than just reliable electrical connections.

[Learn more about the product family.](#)

[Show all products from the family](#)

Subject to changes. Please also observe the further product documentation!

WAGO Kontakttechnik GmbH & Co. KG
Hansastr. 27
32423 Minden
Phone: +49571 887-0 | Fax: +49571 887-169
Email: info.de@wago.com | Web: www.wago.com

Do you have any questions about our products?
We are always happy to take your call at +49 (571) 887-44222.