

**Data sheet | Item number: 2000-1307**

3-conductor ground terminal block; 1 mm<sup>2</sup>; suitable for Ex e II applications;  
side and center marking; for DIN-rail 35 x 15 and 35 x 7.5; Push-in CAGE  
CLAMP®; 1,00 mm<sup>2</sup>; green-yellow

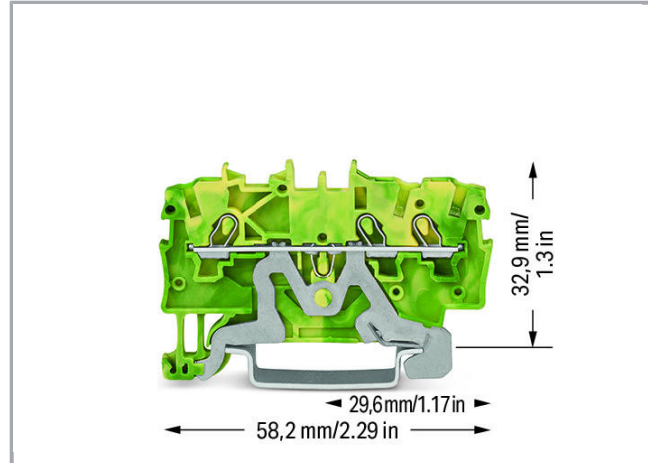

[www.wago.com/2000-1307](http://www.wago.com/2000-1307)

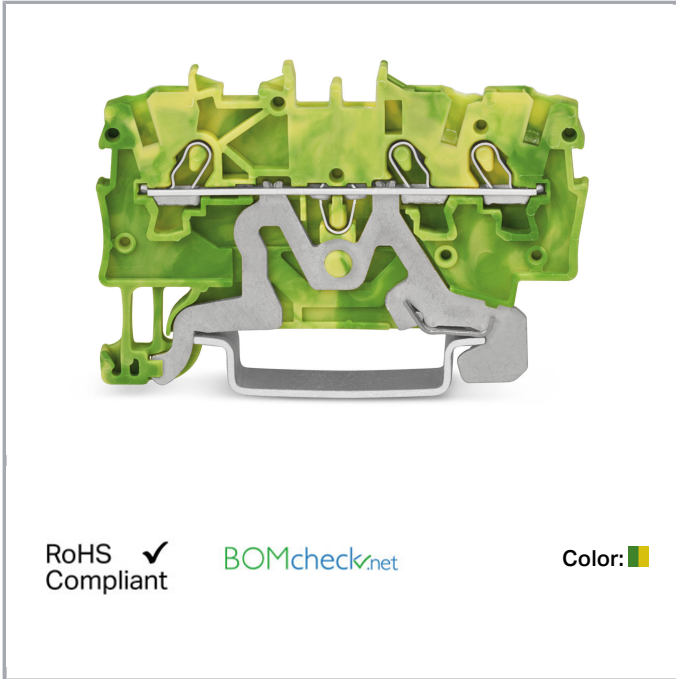

RoHS  Compliant

BOMcheck.net

Color:

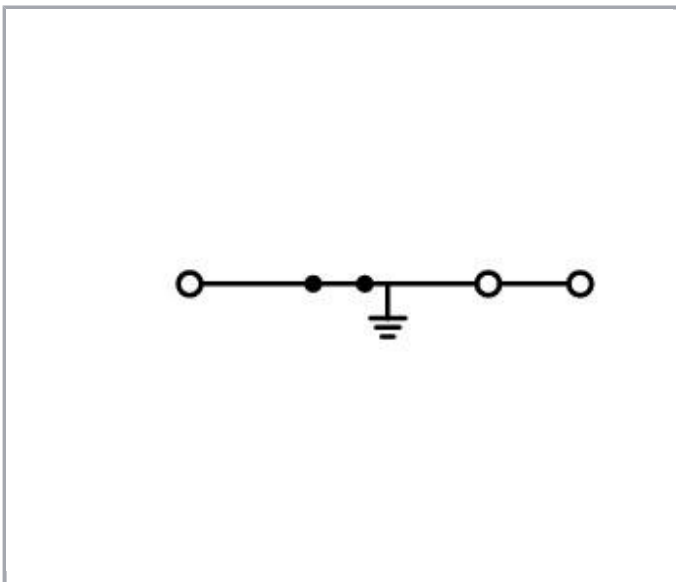

**Data**

**Electrical data**

Subject to changes. Please also observe the further product documentation!

WAGO Kontakttechnik GmbH & Co. KG  
Hansastr. 27  
32423 Minden  
Phone: +49571 887-0 | Fax: +49571 887-169  
Email: [info.de@wago.com](mailto:info.de@wago.com) | Web: [www.wago.com](http://www.wago.com)

Do you have any questions about our products?  
We are always happy to take your call at +49 (571) 887-44222.

## Ratings per IEC/EN 60664-1

Ratings per	IEC/EN 60947-7-2
-------------	------------------

## Connection data

Connection technology	Push-in CAGE CLAMP®
Actuation type	Push-in Open Tool Slot
Connectable conductor materials	Copper
Nominal cross section	1 mm <sup>2</sup>
Solid conductor	0,14 ... 1,5 mm <sup>2</sup> / 24 ... 16 AWG
Solid conductor, push-in termination	0,5 ... 1,5 mm <sup>2</sup> / 20 ... 16 AWG
Fine-stranded conductor	0,14 ... 1,5 mm <sup>2</sup> / 24 ... 16 AWG
Fine-stranded conductor with ferrule with plastic collar	0,5 ... 0,75 mm <sup>2</sup> / 20 ... 18 AWG
Fine-stranded conductor with ferrule, push-in termination, from	0,5 ... 0,75 mm <sup>2</sup> / 20 ... 18 AWG
Strip length	9 ... 11 mm / 0.35 ... 0.43 inch
Total number of connection points	3
Total number of potentials	1
Number of levels	1
Type of wiring	Front-entry wiring
Note (conductor cross-section)	Depending on the conductor characteristic, a conductor with a smaller cross section can also be inserted via push-in termination.
Number of jumper slots	2

## Geometrical Data

Width	3,5 mm / 0.138 inch
Height from upper-edge of DIN-35 rail	32,9 mm / 1.295 inch
Depth	58,2 mm / 2.291 inch

## Mechanical data

Design	horizontal
Type of mounting	DIN-35 rail
Marking level	Center/side marking

## Material Data

Color	green-yellow
-------	--------------

Subject to changes. Please also observe the further product documentation!



Insulating material	Polyamide 66 (PA 66)
Fire load	0.083 MJ
Weight	6.5 g

### Commercial data



Product Group	22 (TOPJOB S)
Packaging type	BOX
Country of origin	CN
GTIN	4045454966904
Customs Tariff No.	85369010000

### Approvals / Certificates

#### Ex-Approvals

Logo	Approval	Additional Approval Text	Certificate name
	AEx Underwriters Laboratories Inc.	UL 60079	E185892
	ATEX Physikalisch Technische Bundesanstalt	EN 60079	PTB 11 ATEX 1041 U (II 2 G Ex e IIC GB / I M 2 Ex e I Mb)

#### Country specific Approvals

Logo	Approval	Additional Approval Text	Certificate name
	CCA DEKRA Certification B.V.	EN 60947	71- 102841
	CSA DEKRA Certification B.V.	C22.2 No. 158	2130762

#### Ship Approvals

Logo	Approval	Additional Approval Text	Certificate name
------	----------	--------------------------	------------------

Subject to changes. Please also observe the further product documentation!

	<b>ABS</b> American Bureau of Shipping	EN 60947	20- HG1941090- PDA
	<b>BV</b> Bureau Veritas S.A.	EN 60947	38586/A0 BV
	<b>DNV GL</b> Det Norske Veritas, Germanischer Lloyd	-	TAE00001V2
	<b>LR</b> Lloyds Register	EN 60947	91/20112 (E9)

## Counterpart

## Compatible products



### Test Accessories

<b>Item no.: 2000-510</b> TOPJOB®S L-type test plug module; modular; for jumper contact slot; 1,00 mm²; gray	<a href="http://www.wago.com/2000-510">www.wago.com/2000-510</a>
<b>Item no.: 2000-511</b> TOPJOB®S L-type test plug module; modular; for jumper contact slot; 1-pole; 1,00 mm²; gray	<a href="http://www.wago.com/2000-511">www.wago.com/2000-511</a>
<b>Item no.: 2000-549</b> Spacer module; modular; e.g., for bridging commoned terminal blocks; gray	<a href="http://www.wago.com/2000-549">www.wago.com/2000-549</a>
<b>Item no.: 2000-552</b> Modular TOPJOB®S connector; modular; for jumper contact slot; 2-pole; 1,00 mm²; gray	<a href="http://www.wago.com/2000-552">www.wago.com/2000-552</a>
<b>Item no.: 2000-553</b> Modular TOPJOB®S connector; modular; for jumper contact slot; 3-pole; 1,00 mm²; gray	<a href="http://www.wago.com/2000-553">www.wago.com/2000-553</a>

Subject to changes. Please also observe the further product documentation!

WAGO Kontakttechnik GmbH & Co. KG  
Hansastr. 27  
32423 Minden  
Phone: +49571 887-0 | Fax: +49571 887-169  
Email: [info.de@wago.com](mailto:info.de@wago.com) | Web: [www.wago.com](http://www.wago.com)

Do you have any questions about our products?  
We are always happy to take your call at +49 (571) 887-44222.

	<b>Item no.: 2000-554</b> Modular TOPJOB®S connector; modular; for jumper contact slot; 4-pole; 1,00 mm <sup>2</sup> ; gray	<a href="http://www.wago.com/2000-554">www.wago.com/2000-554</a>
	<b>Item no.: 2000-555</b> Modular TOPJOB®S connector; modular; for jumper contact slot; 5-pole; 1,00 mm <sup>2</sup> ; gray	<a href="http://www.wago.com/2000-555">www.wago.com/2000-555</a>
	<b>Item no.: 2000-556</b> Modular TOPJOB®S connector; modular; for jumper contact slot; 6-pole; 1,00 mm <sup>2</sup> ; gray	<a href="http://www.wago.com/2000-556">www.wago.com/2000-556</a>
	<b>Item no.: 2000-557</b> Modular TOPJOB®S connector; modular; for jumper contact slot; 7-pole; 1,00 mm <sup>2</sup> ; gray	<a href="http://www.wago.com/2000-557">www.wago.com/2000-557</a>
	<b>Item no.: 2000-558</b> Modular TOPJOB®S connector; modular; for jumper contact slot; 8-pole; 1,00 mm <sup>2</sup> ; gray	<a href="http://www.wago.com/2000-558">www.wago.com/2000-558</a>
	<b>Item no.: 2000-559</b> Modular TOPJOB®S connector; modular; for jumper contact slot; 9-pole; 1,00 mm <sup>2</sup> ; gray	<a href="http://www.wago.com/2000-559">www.wago.com/2000-559</a>
	<b>Item no.: 2000-560</b> Modular TOPJOB®S connector; modular; for jumper contact slot; 10-pole; 1,00 mm <sup>2</sup> ; gray	<a href="http://www.wago.com/2000-560">www.wago.com/2000-560</a>
	<b>Item no.: 2009-174</b> Test plug adapter; for 4 mm Ø test plugs; for testing TOPJOB®S rail-mounted terminal blocks; gray	<a href="http://www.wago.com/2009-174">www.wago.com/2009-174</a>
	<b>Item no.: 2009-182</b> Testing tap; for max. 2.5 mm <sup>2</sup> ; tool-free connection for individual test wires 0.08 - 2.5 mm; gray	<a href="http://www.wago.com/2009-182">www.wago.com/2009-182</a>
	<b>Item no.: 210-136</b> Test plug; 2 mm Ø; with 500 mm cable; red	<a href="http://www.wago.com/210-136">www.wago.com/210-136</a>
	<b>Item no.: 210-137</b> Test plug; 2.3 mm Ø; with 500 mm cable; yellow	<a href="http://www.wago.com/210-137">www.wago.com/210-137</a>
<b>Carrier rail</b>		
	<b>Item no.: 210-112</b> Steel carrier rail; 35 x 7.5 mm; 1 mm thick; 2 m long; slotted; according to EN 60715; "Hole width 25 mm	<a href="http://www.wago.com/210-112">www.wago.com/210-112</a>
	<b>Item no.: 210-113</b> Steel carrier rail; 35 x 7.5 mm; 1 mm thick; 2 m long; unslotted; according to EN 60715	<a href="http://www.wago.com/210-113">www.wago.com/210-113</a>
	<b>Item no.: 210-114</b> Steel carrier rail; 35 x 15 mm; 1.5 mm thick; 2 m long; unslotted; similar to EN 60715	<a href="http://www.wago.com/210-114">www.wago.com/210-114</a>
	<b>Item no.: 210-115</b> Steel carrier rail; 35 x 7.5 mm; 1 mm thick; 2 m long; slotted; according to EN 60715; "Hole width 18 mm	<a href="http://www.wago.com/210-115">www.wago.com/210-115</a>
	<b>Item no.: 210-118</b> Steel carrier rail; 35 x 15 mm; 2.3 mm thick; 2 m long; unslotted; according to EN 60715	<a href="http://www.wago.com/210-118">www.wago.com/210-118</a>
	<b>Item no.: 210-196</b> Aluminum carrier rail; 35 x 8.2 mm; 1.6 mm thick; 2 m long; unslotted; similar to EN 60715; silver-colored	<a href="http://www.wago.com/210-196">www.wago.com/210-196</a>
	<b>Item no.: 210-197</b> Steel carrier rail; 35 x 15 mm; 1.5 mm thick; 2 m long; slotted; similar to EN 60715	<a href="http://www.wago.com/210-197">www.wago.com/210-197</a>

Subject to changes. Please also observe the further product documentation!

**Item no.: 210-198**

Copper carrier rail; 35 x 15 mm; 2.3 mm thick; 2 m long; unslotted; according to EN 60715; copper-colored

[www.wago.com/210-198](http://www.wago.com/210-198)

**Protective Warning Marker**

**Item no.: 2000-115**

Protective warning marker; with high-voltage symbol, black; for 5 terminal blocks; yellow

[www.wago.com/2000-115](http://www.wago.com/2000-115)

**End plate**



**Item no.: 2000-1391**

End and intermediate plate; 0.7 mm thick; gray

[www.wago.com/2000-1391](http://www.wago.com/2000-1391)



**Item no.: 2000-1392**

End and intermediate plate; 0.7 mm thick; orange

[www.wago.com/2000-1392](http://www.wago.com/2000-1392)

**Item no.: 209-191**

Separator for Ex e/Ex i applications; 3 mm thick; 120 mm wide; orange

[www.wago.com/209-191](http://www.wago.com/209-191)

**Marking accessories**

**Item no.: 2009-110**

Marking strips; on reel; not stretchable; plain; snap-on type; white

[www.wago.com/2009-110](http://www.wago.com/2009-110)

**Item no.: 2009-113**

WMB-Inline; for Smart Printer; 2300 pieces on roll; plain; snap-on type; white

[www.wago.com/2009-113](http://www.wago.com/2009-113)

**Item no.: 2009-113/000-002**

WMB-Inline; for Smart Printer; 2300 pieces on roll; plain; snap-on type; yellow

[www.wago.com/2009-113/000-002](http://www.wago.com/2009-113/000-002)

**Item no.: 2009-113/000-005**

WMB-Inline; for Smart Printer; 2300 pieces on roll; plain; snap-on type; red

[www.wago.com/2009-113/000-005](http://www.wago.com/2009-113/000-005)

**Item no.: 2009-113/000-006**

WMB-Inline; for Smart Printer; 2300 pieces on roll; plain; snap-on type; blue

[www.wago.com/2009-113/000-006](http://www.wago.com/2009-113/000-006)

**Item no.: 2009-113/000-007**

WMB-Inline; for Smart Printer; 2300 pieces on roll; plain; snap-on type; gray

[www.wago.com/2009-113/000-007](http://www.wago.com/2009-113/000-007)

**Item no.: 2009-113/000-012**

WMB-Inline; for Smart Printer; 2300 pieces on roll; plain; snap-on type; orange

[www.wago.com/2009-113/000-012](http://www.wago.com/2009-113/000-012)

**Item no.: 2009-113/000-017**

WMB-Inline; for Smart Printer; 2300 pieces on roll; plain; snap-on type; light green

[www.wago.com/2009-113/000-017](http://www.wago.com/2009-113/000-017)

**Item no.: 2009-113/000-023**

WMB-Inline; for Smart Printer; 2300 pieces on roll; plain; snap-on type; green

[www.wago.com/2009-113/000-023](http://www.wago.com/2009-113/000-023)

Subject to changes. Please also observe the further product documentation!

WAGO Kontakttechnik GmbH & Co. KG

Hansastr. 27

32423 Minden

Phone: +49571 887-0 | Fax: +49571 887-169

Email: [info.de@wago.com](mailto:info.de@wago.com) | Web: [www.wago.com](http://www.wago.com)

Do you have any questions about our products?

We are always happy to take your call at +49 (571) 887-44222.

**Item no.: 2009-113/000-024**

WMB-Inline; for Smart Printer; 2300 pieces on roll; plain; snap-on type; violet

[www.wago.com/2009-113/000-024](http://www.wago.com/2009-113/000-024)**Item no.: 2009-191**

Group marker carrier

[www.wago.com/2009-191](http://www.wago.com/2009-191)**Item no.: 793-3501**

WMB marking card; as card; plain; snap-on type; white

[www.wago.com/793-3501](http://www.wago.com/793-3501)**Push-In type wire jumper****Item no.: 2009-402**Push-in type wire jumper; insulated; wire length 60 mm; Conductor cross section 0.75 mm<sup>2</sup>; suitable for 2000 and 2020 Series rail-mounted terminal blocks; gray[www.wago.com/2009-402](http://www.wago.com/2009-402)**Item no.: 2009-404**Push-in type wire jumper; insulated; wire length 110 mm; Conductor cross section 0.75 mm<sup>2</sup>; suitable for 2000 and 2020 Series rail-mounted terminal blocks; gray[www.wago.com/2009-404](http://www.wago.com/2009-404)**Item no.: 2009-406**Push-in type wire jumper; insulated; wire length 250 mm; Conductor cross section 0.75 mm<sup>2</sup>; suitable for 2000 and 2020 Series rail-mounted terminal blocks; gray[www.wago.com/2009-406](http://www.wago.com/2009-406)**ferrule****Item no.: 216-241**Ferrule; Sleeve for 0.5 mm<sup>2</sup> / 20 AWG; insulated; electro-tin plated; electrolytic copper; gastight crimped; acc. to DIN 46228, Part 4/09.90; white[www.wago.com/216-241](http://www.wago.com/216-241)**Item no.: 216-242**Ferrule; Sleeve for 0.75 mm<sup>2</sup> / 18 AWG; insulated; electro-tin plated; electrolytic copper; gastight crimped; acc. to DIN 46228, Part 4/09.90; gray[www.wago.com/216-242](http://www.wago.com/216-242)**Item no.: 216-243**Ferrule; Sleeve for 1 mm<sup>2</sup> / AWG 18; insulated; electro-tin plated; electrolytic copper; gastight crimped; acc. to DIN 46228, Part 4/09.90; red[www.wago.com/216-243](http://www.wago.com/216-243)**Jumper****Item no.: 2000-402**

Push-in type jumper bar; insulated; 2-way; Nominal current 14 A; light gray

[www.wago.com/2000-402](http://www.wago.com/2000-402)**Item no.: 2000-402/000-005**

Push-in type jumper bar; insulated; 2-way; Nominal current 14 A; red

[www.wago.com/2000-402/000-005](http://www.wago.com/2000-402/000-005)**Item no.: 2000-402/000-006**

Push-in type jumper bar; insulated; 2-way; Nominal current 14 A; blue

[www.wago.com/2000-402/000-006](http://www.wago.com/2000-402/000-006)**Item no.: 2000-402/000-018**

Push-in type jumper bar; insulated; 2-way; Nominal current 14 A; yellow-green

[www.wago.com/2000-402/000-018](http://www.wago.com/2000-402/000-018)**Item no.: 2000-403**

Push-in type jumper bar; insulated; 3-way; Nominal current 14 A; light gray

[www.wago.com/2000-403](http://www.wago.com/2000-403)

Subject to changes. Please also observe the further product documentation!

WAGO Kontakttechnik GmbH &amp; Co. KG

Hansastr. 27

32423 Minden

Phone: +49571 887-0 | Fax: +49571 887-169

Email: [info.de@wago.com](mailto:info.de@wago.com) | Web: [www.wago.com](http://www.wago.com)

Do you have any questions about our products?

We are always happy to take your call at +49 (571) 887-44222.

**Item no.: 2000-403/000-005**

Push-in type jumper bar; insulated; 3-way; Nominal current 14 A; red

[www.wago.com/2000-403/000-005](http://www.wago.com/2000-403/000-005)

**Item no.: 2000-403/000-006**

Push-in type jumper bar; insulated; 3-way; Nominal current 14 A; blue

[www.wago.com/2000-403/000-006](http://www.wago.com/2000-403/000-006)

**Item no.: 2000-404**

Push-in type jumper bar; insulated; 4-way; Nominal current 14 A; light gray

[www.wago.com/2000-404](http://www.wago.com/2000-404)

**Item no.: 2000-404/000-005**

Push-in type jumper bar; insulated; 4-way; Nominal current 14 A; red

[www.wago.com/2000-404/000-005](http://www.wago.com/2000-404/000-005)

**Item no.: 2000-404/000-006**

Push-in type jumper bar; insulated; 4-way; Nominal current 14 A; blue

[www.wago.com/2000-404/000-006](http://www.wago.com/2000-404/000-006)

**Item no.: 2000-405**

Push-in type jumper bar; insulated; 5-way; Nominal current 14 A; light gray

[www.wago.com/2000-405](http://www.wago.com/2000-405)

**Item no.: 2000-405/000-005**

Push-in type jumper bar; insulated; 5-way; Nominal current 14 A; red

[www.wago.com/2000-405/000-005](http://www.wago.com/2000-405/000-005)

**Item no.: 2000-405/000-006**

Push-in type jumper bar; insulated; 5-way; Nominal current 14 A; blue

[www.wago.com/2000-405/000-006](http://www.wago.com/2000-405/000-006)



**Item no.: 2000-405/011-000**

Star point jumper; insulated; 3-way (1-3-5); IN = IN terminal block; light gray

[www.wago.com/2000-405/011-000](http://www.wago.com/2000-405/011-000)

**Item no.: 2000-406**

Push-in type jumper bar; insulated; 6-way; Nominal current 14 A; light gray

[www.wago.com/2000-406](http://www.wago.com/2000-406)

**Item no.: 2000-406/000-005**

Push-in type jumper bar; insulated; 6-way; Nominal current 14 A; red

[www.wago.com/2000-406/000-005](http://www.wago.com/2000-406/000-005)

**Item no.: 2000-406/000-006**

Push-in type jumper bar; insulated; 6-way; Nominal current 14 A; blue

[www.wago.com/2000-406/000-006](http://www.wago.com/2000-406/000-006)

**Item no.: 2000-406/020-000**

Delta jumper; insulated; 1-2 3-4 5-6; IN = IN terminal block; light gray

[www.wago.com/2000-406/020-000](http://www.wago.com/2000-406/020-000)

**Item no.: 2000-407**

Push-in type jumper bar; insulated; 7-way; Nominal current 14 A; light gray

[www.wago.com/2000-407](http://www.wago.com/2000-407)

Subject to changes. Please also observe the further product documentation!

WAGO Kontakttechnik GmbH & Co. KG

Hansastr. 27

32423 Minden

Phone: +49571 887-0 | Fax: +49571 887-169

Email: [info.de@wago.com](mailto:info.de@wago.com) | Web: [www.wago.com](http://www.wago.com)

Do you have any questions about our products?

We are always happy to take your call at +49 (571) 887-44222.





**Item no.: 2000-407/000-005**

Push-in type jumper bar; insulated; 7-way; Nominal current 14 A; red

[www.wago.com/2000-407/000-005](http://www.wago.com/2000-407/000-005)

**Item no.: 2000-407/000-006**

Push-in type jumper bar; insulated; 7-way; Nominal current 14 A; blue

[www.wago.com/2000-407/000-006](http://www.wago.com/2000-407/000-006)

**Item no.: 2000-408**

Push-in type jumper bar; insulated; 8-way; Nominal current 14 A; light gray

[www.wago.com/2000-408](http://www.wago.com/2000-408)

**Item no.: 2000-408/000-005**

Push-in type jumper bar; insulated; 8-way; Nominal current 14 A; red

[www.wago.com/2000-408/000-005](http://www.wago.com/2000-408/000-005)

**Item no.: 2000-408/000-006**

Push-in type jumper bar; insulated; 8-way; Nominal current 14 A; blue

[www.wago.com/2000-408/000-006](http://www.wago.com/2000-408/000-006)

**Item no.: 2000-409**

Push-in type jumper bar; insulated; 9-way; Nominal current 14 A; light gray

[www.wago.com/2000-409](http://www.wago.com/2000-409)

**Item no.: 2000-409/000-005**

Push-in type jumper bar; insulated; 9-way; Nominal current 14 A; red

[www.wago.com/2000-409/000-005](http://www.wago.com/2000-409/000-005)

**Item no.: 2000-409/000-006**

Push-in type jumper bar; insulated; 9-way; Nominal current 14 A; blue

[www.wago.com/2000-409/000-006](http://www.wago.com/2000-409/000-006)

**Item no.: 2000-410**

Push-in type jumper bar; insulated; 10-way; Nominal current 14 A; light gray

[www.wago.com/2000-410](http://www.wago.com/2000-410)

**Item no.: 2000-410/000-005**

Push-in type jumper bar; insulated; 10-way; Nominal current 14 A; red

[www.wago.com/2000-410/000-005](http://www.wago.com/2000-410/000-005)

**Item no.: 2000-410/000-006**

Push-in type jumper bar; insulated; 10-way; Nominal current 14 A; blue

[www.wago.com/2000-410/000-006](http://www.wago.com/2000-410/000-006)

**Item no.: 2000-433**

Push-in type jumper bar; insulated; from 1 to 3; Nominal current 14 A; light gray

[www.wago.com/2000-433](http://www.wago.com/2000-433)

**Item no.: 2000-433/000-005**

Push-in type jumper bar; insulated; from 1 to 3; Nominal current 14 A; red

[www.wago.com/2000-433/000-005](http://www.wago.com/2000-433/000-005)

**Item no.: 2000-433/000-006**

Push-in type jumper bar; insulated; from 1 to 3; Nominal current 14 A; blue

[www.wago.com/2000-433/000-006](http://www.wago.com/2000-433/000-006)

Subject to changes. Please also observe the further product documentation!

WAGO Kontakttechnik GmbH & Co. KG

Hansastr. 27

32423 Minden

Phone: +49571 887-0 | Fax: +49571 887-169

Email: [info.de@wago.com](mailto:info.de@wago.com) | Web: [www.wago.com](http://www.wago.com)

Do you have any questions about our products?

We are always happy to take your call at +49 (571) 887-44222.



	<b>Item no.: 2000-434</b> Push-in type jumper bar; insulated; from 1 to 4; Nominal current 14 A; light gray	<a href="http://www.wago.com/2000-434">www.wago.com/2000-434</a>
	<b>Item no.: 2000-435</b> Push-in type jumper bar; insulated; from 1 to 5; Nominal current 14 A; light gray	<a href="http://www.wago.com/2000-435">www.wago.com/2000-435</a>
	<b>Item no.: 2000-436</b> Push-in type jumper bar; insulated; from 1 to 6; Nominal current 14 A; light gray	<a href="http://www.wago.com/2000-436">www.wago.com/2000-436</a>
	<b>Item no.: 2000-437</b> Push-in type jumper bar; insulated; from 1 to 7; Nominal current 14 A; light gray	<a href="http://www.wago.com/2000-437">www.wago.com/2000-437</a>
	<b>Item no.: 2000-438</b> Push-in type jumper bar; insulated; from 1 to 8; Nominal current 14 A; light gray	<a href="http://www.wago.com/2000-438">www.wago.com/2000-438</a>
	<b>Item no.: 2000-439</b> Push-in type jumper bar; insulated; from 1 to 9; Nominal current 14 A; light gray	<a href="http://www.wago.com/2000-439">www.wago.com/2000-439</a>
	<b>Item no.: 2000-440</b> Push-in type jumper bar; insulated; from 1 to 10; Nominal current 14 A; light gray	<a href="http://www.wago.com/2000-440">www.wago.com/2000-440</a>
	<b>Item no.: 210-103</b> Wire commoning chain; insulated; 50 connections; black	<a href="http://www.wago.com/210-103">www.wago.com/210-103</a>
	<b>Item no.: 210-123</b> Wire commoning chain; insulated; 50 connections	<a href="http://www.wago.com/210-123">www.wago.com/210-123</a>
<b>tools</b>		
	<b>Item no.: 210-647</b> Operating tool; Blade: 2.5 x 0.4 mm; with a partially insulated shaft	<a href="http://www.wago.com/210-647">www.wago.com/210-647</a>
	<b>Item no.: 210-648</b> Operating tool; Blade: 2.5 x 0.4 mm; with a partially insulated shaft; angled; short	<a href="http://www.wago.com/210-648">www.wago.com/210-648</a>
	<b>Item no.: 210-719</b> Operating tool; Blade: 2.5 x 0.4 mm; with a partially insulated shaft	<a href="http://www.wago.com/210-719">www.wago.com/210-719</a>

## Downloads

### Documentation

#### Additional Information

Technical explanations	Apr 3, 2019	pdf 2.1 MB	Download
------------------------	-------------	---------------	----------

## CAD/CAE-Data

### CAD data

2D/3D Models 2000-1307	URL	Download
------------------------	-----	----------

Subject to changes. Please also observe the further product documentation!

WAGO Kontakttechnik GmbH & Co. KG  
 Hansastr. 27  
 32423 Minden  
 Phone: +49571 887-0 | Fax: +49571 887-169  
 Email: [info.de@wago.com](mailto:info.de@wago.com) | Web: [www.wago.com](http://www.wago.com)

Do you have any questions about our products?  
 We are always happy to take your call at +49 (571) 887-44222.

CAE data

EPLAN Data Portal 2000-1307

URL

Download

WSCAD Universe 2000-1307

URL

Download

Installation Notes

Inserting a conductor

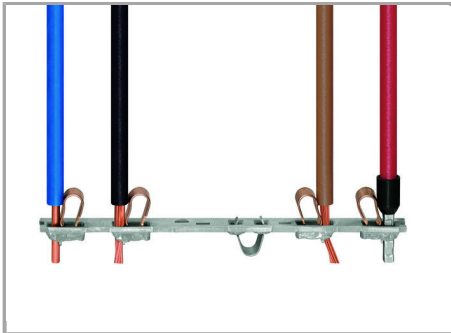

All conductor types at a glance

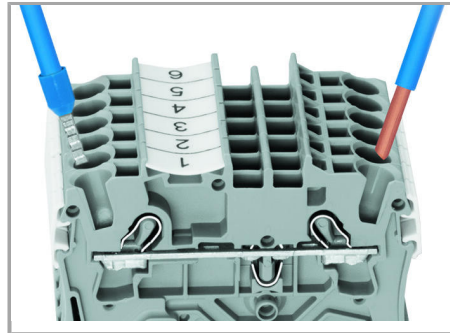

Terminating solid and ferruled conductors via push-in connection.

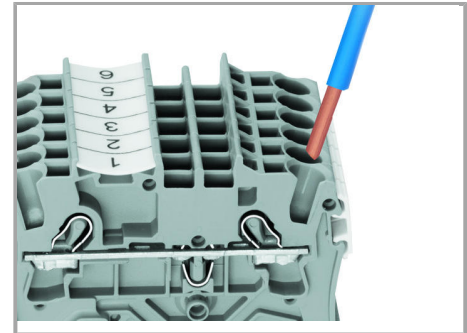

Inserting conductors via push-in termination.

**Solid conductors** with cross-sections from either one size above, or up to two sizes below, the rated cross-section can be simply pushed in – no tools needed.

Subject to changes. Please also observe the further product documentation!



Inserting a conductor via operating tool.

Connecting fine-stranded conductors without ferrules, or small cross-sectional conductors that cannot be pushed in, is performed similarly to the original CAGE CLAMP® – just use an operating tool.

#### The smart feature:

To open the clamp, the operating tool is inserted vertically. The conductor entry is less than 15 degrees for easier wiring.

#### Commoning

Subject to changes. Please also observe the further product documentation!



The push-in type jumper bar system is based on the common plug and socket principle. Each terminal block is spring-loaded with a double socket and a resilient CrNi steel spring. The jumper contact material is pure electrolytic copper, which allows for an extremely small design capable of carrying the full-rated current of the terminal block. Ground terminal blocks can also be commoned using the same jumper system. Custom jumpers are created by breaking and removing jumper contacts (2000, 2001, 2002, 2004 Series).

#### Removing a push-in type jumper bar.

Insert the operating tool between the jumper and and partition wall of the dual jumper slots, then lift up the jumper.

Place the operating tool in the center of jumpers up to five contacts (see above), or alternately on both sides for jumpers with more than five contacts.

#### Commoning



This star point jumper has been specially developed to create a "star point" and is used on motor terminal boards equipped with TOPJOB® S rail-mount terminal blocks.

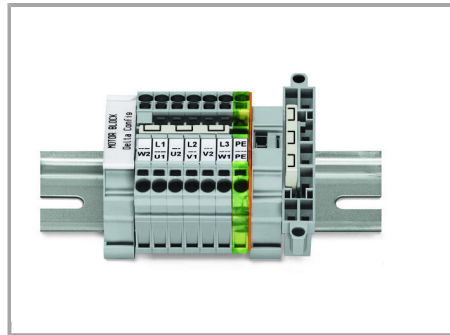

This delta jumper has been specially developed to create a delta configuration and is used on motor terminal boards equipped with TOPJOB® S rail-mount terminal blocks.

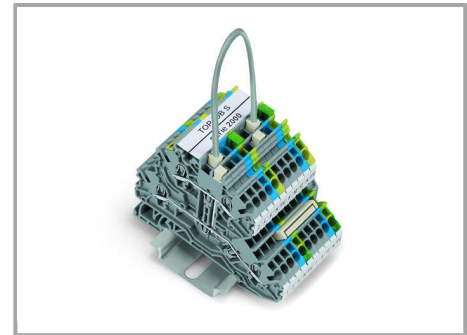

Push down the wire jumper (2009-402) until fully inserted. Lift the jumper with an operating tool for rewiring.

#### Testing

Subject to changes. Please also observe the further product documentation!

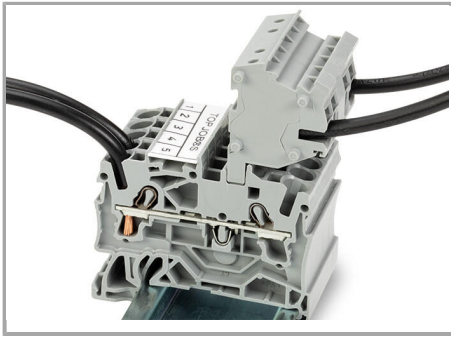

The modular TOPJOB® S connectors also connect conductors of the same size as the terminal blocks being used.

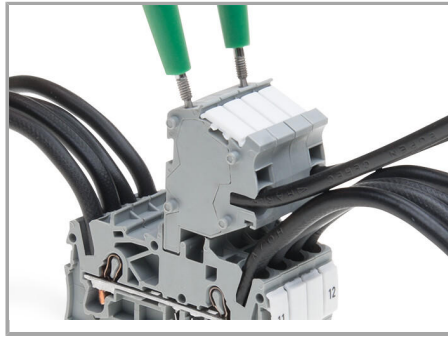

TOPJOB® S Connectors with a 2 mm Ø test socket for testing voltage via 2-pole voltage tester

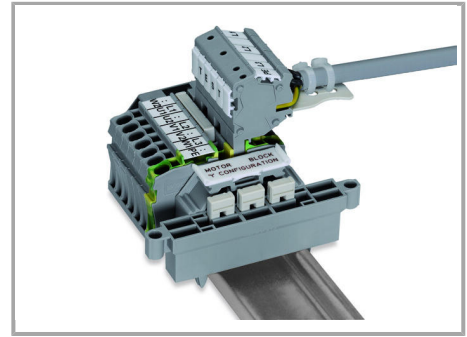

Rail-mount terminal block assembly for electric motor wiring

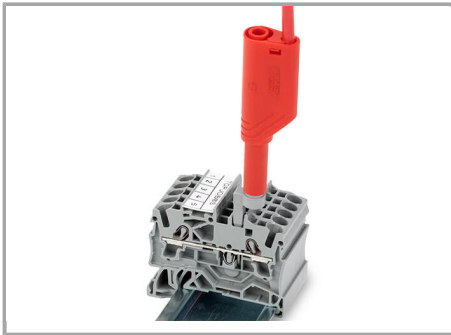

Test plug adapter (2009-174, CAT II) for 4 mm Ø plugs – compatible with 2000 to 2016 Series

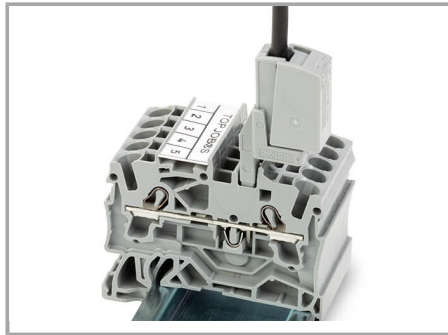

Testing tap (2009-182) for tool-free connection of test cables up to 2.5 mm<sup>2</sup> (12 AWG) – compatible with 2000 to 2016 Series

### Marking

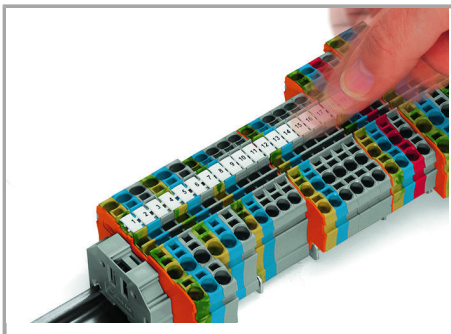

Snapping WMB Inline markers into marker slots.

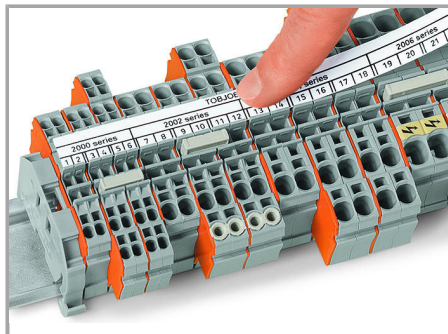

Subject to changes. Please also observe the further product documentation!

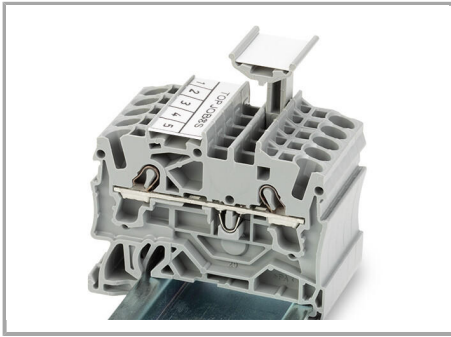

TOPJOB® S 2009-193 Group Marker Carrier  
(equipped with a marking strip) for all 2001 to  
2016 Series TOPJOB® S Rail-Mount Terminal  
Blocks

Do not use on an end plate!

## Product family

### TOPJOB® S

TOPJOB® S: In various industrial applications and modern building installations, WAGO's wide and versatile range of rail-mount terminal blocks provides more than just reliable electrical connections.

[Learn more about the product family.](#)

[Show all products from the family](#)

Subject to changes. Please also observe the further product documentation!